

**A CENTURY OF CHEMICAL
ENGINEERING AT THE
UNIVERSITY OF MICHIGAN**

**A CENTURY OF CHEMICAL ENGINEERING
AT THE UNIVERSITY OF MICHIGAN**

Chapter 1

NOTABLE EVENTS AT MICHIGAN

Introduction

AT the University of Michigan, a course of study leading to a bachelor's degree in chemical engineering was initiated by Prof. Edward DeMille Campbell in 1898. Subsequent major events included the 1923 move from the Chemistry Building to the new East Engineering Building and in 1982 to the new Herbert H. Dow Building on North Campus. The department was renamed Chemical and Metallurgical Engineering in 1935, but later separated in 1971 as the Chemical Engineering Department. A quick overview of our 104-year history can be obtained from the following "milestones."

Milestones

<i>Year</i>	<i>Event</i>
1890s	
1890	Edward DeMille Campbell is appointed assistant professor of metallurgy.
1897	Alfred H. White is appointed instructor in chemical technology.
1898	The Board of Regents approve Dean Charles E. Greene's request for the first course of study at the University of Michigan leading to a bachelor of science in chemical engineering. The coursework, third or fourth in the nation, is directed by Prof. Edward DeMille Campbell, with cooperation from the Chemistry Department.
1900s	
1900	The Michigan Gas Association establishes a long-running fellowship in chemical engineering.
1900	With the old Chemistry Building filled to capacity, chemical engineering work, including gas analysis and metallography, continues in what would later become the Economics Building.

- 1903 Five students become the first class to graduate with degrees in chemical engineering from the U–M, although, with some course substitutions, Wareham Baldwin received the first degree in 1901 and Norman Harriman the second in 1902. Requirements for graduation then were 130 hours of credit and a thesis.
- 1905 Edward DeMille Campbell is appointed director of the Chemical Laboratory.
- 1908 The importance of the emerging program is recognized with Alfred H. White’s promotion to junior professor of chemical engineering, and by the separate listing of chemical engineering courses, including metallurgy, in the *College of Engineering Announcement*.
- 1909 A growing department now graduates an average of twenty students a year. The department is allotted ample space in the newly constructed Chemistry Building. Staff now consists of Professors Campbell and White, and Instructor Karl Wilhelm Zimmerschied, who would further develop the course in metallurgy and extend the coursework in extractive metallurgy.

1910s

- 1911 The Mentor Program of faculty counseling and leadership is established by Dean Cooley.
- 1913 Alfred H. White publishes *Technical Gas and Fuel Analysis*.
- 1914 Edward DeMille Campbell resigns his professorship in chemical engineering, but continues as a professor of chemistry and concentrates his efforts on directing the Chemical Laboratory.
- 1914 Alfred H. White is appointed head of the Department of Chemical Engineering.
- 1915 Courses in unit operations are introduced by Walter Badger.
- 1917 The department accepts some large-scale equipment from the Swenson Evaporator Company, but, because of space restrictions in the Chemistry Building, has to install it in an abandoned boiler house in the center of campus.
- 1919 Dorothy Hall is the first woman to graduate with a bachelor’s degree from our department.

1920s

- 1920 By 1920/1921, more than one hundred U–M sophomores choose chemical engineering as their field of specialization.

- 1922 The first student chapter in the nation of the AIChE is established on the Michigan campus.
- 1923 George Granger Brown organizes the first U–M graduate course in thermodynamics.
- 1923 Chemical engineering moves to the new East Engineering Building, enhancing the rapidly emerging Ph.D. program.
- 1924 George Granger Brown completes his doctoral dissertation, *The Rate of Pressure Rise in Gaseous Explosions*, under the supervision of Eugene H. Leslie.
- 1925 Edward DeMille Campbell dies on 18 September.
- 1925 Chemical engineering is recognized nationally as a branch of engineering. The University of Michigan has one of 14 accredited curricula listed by the AIChE. Also in this year, the American Society for Metals establishes the Edward DeMille Campbell Lecture, to honor the memory of this nationally recognized pioneer in theoretical metallurgy.
- 1927 Albert E. White and Clair Upthegrove contribute to a symposium on metals and alloys at elevated temperatures, sponsored by the ASTM and the ASME. While some work had been done previously, this marked the real beginning, under A.E. White's direction, of a research program that would bring the University of Michigan recognition throughout the world. This program, through the Engineering Research Institute, also establishes a laboratory for the study of metals at elevated temperatures, which by 1954 was one of the largest and best of its kind.
- 1928 Walter J. Podbielniak receives his Ph.D.
- 1928 Walter L. Badger and Edwin M. Baker publish *Inorganic Chemical Technology*.
- 1929 Alfred H. White becomes president of the AIChE.
- 1929 The department has 41 graduate students, of whom 23 already have their master's degree and are working for the doctorate.

1930s

- 1930 G.G. Brown is promoted to professor, having started as an assistant professor in 1925.
- 1930 There are 13 members on our faculty.
- 1931 Professors Badger and McCabe publish *Elements of Chemical Engineering*, which soon becomes the most widely used text in the field.

- 1934 The U-M Chemical Engineering Department is ranked by the American Council on Education as one of the top three “most distinguished” programs in the nation. Criteria include the adequacy of staff and equipment to prepare candidates for the doctorate.
- 1935 The College of Engineering creates two separate programs, in chemical engineering and metallurgy. Our name is changed to the Chemical and Metallurgical Engineering Department. By 1935, 20 percent of all graduate students in the United States working toward the master’s degree in chemical engineering, and 13 percent of those studying for the doctorate, are enrolled at the University of Michigan.
- 1935 Undergraduate Brymer Williams pays \$3.50/week for accommodation in a rooming house and another \$3.50/week for meals.
- 1936 Drake Parker and colleagues institute the Badger Trophy for—to put it politely—the least elegant piece of laboratory equipment constructed during the year.
- 1936 Donald L. Katz (U–M Ph.D. 1933) joins the chemical engineering faculty after working for three years with the Phillips Petroleum Company.

1940s

- 1942 G.G. Brown becomes the third chairman of the department.
- 1944 G.G. Brown becomes president of the AIChE.
- 1947 G.G. Brown is appointed the Edward DeMille Campbell University Professor of Chemical Engineering.
- 1948 There are 29 members on our chemical and metallurgical engineering faculty.
- 1948 The department celebrates its 50th anniversary. Over two hundred chemical and metallurgical engineering alumni from across the nation attend the gala celebration. In its first 50 years, the department has enrolled a total of 3,876 undergraduate students and granted 2,151 bachelor’s degrees; in the Graduate School, 940 higher degrees have been granted. The teaching staff number 25, undergraduate students amount to 510 in chemical and 80 in metallurgical engineering, with 197 graduate students.
- 1948 Biomedically oriented chemical engineering research is initiated by Prof. Cedomir Sliepcevich, working with graduate student Phil Bocquet.

1949 Our graduate enrollment reaches a peak of 235 students.

1950s

- 1950 The landmark text, *Unit Operations*, a collaborative U–M work prepared under the leadership of G.G. Brown, is published. The book is promptly adopted by 115 institutions, including almost all the departments of chemical engineering in the United States. Robert R. White introduces the “rate operations” concept at about the same time.
- 1950 Stuart Churchill is appointed as an instructor and completes his Ph.D. two years later.
- 1951 Donald L. Katz is appointed as the fourth chairman of the department, and G.G. Brown becomes the dean of the College of Engineering.
- 1952 Prof. Lloyd Kempe continues the earlier initiative of Prof. Slipecevich and pioneers our program in biochemical engineering and applied microbiology.
- 1952 In the 20-year period from 1932 to 1952, 137 doctoral degrees are granted in chemical or metallurgical engineering.
- 1953 Alfred and Rebecca White celebrate their 50th wedding anniversary on 28 July.
- 1953 Graduate student Ronald Crozier is the first ChE student to use MIDAC, the new digital computer at the U–M’s Willow Run Laboratory.
- 1954 At the U–M campus, Professor Katz leads the first national conference on the peaceful uses of nuclear energy. By this year, chemical and metallurgical engineering staff had authored seven or more major books and more than seven hundred publications.
- 1955 Graduate student Jim Wilkes pays \$9/week for a room at 1229 Traver Road and budgets another \$2/day for meals.
- 1956 The IBM 650 computer in the basement of the Rackham Building, with 2,000 words of drum storage, sees significant student use.
- 1957 The G.G. Brown Building opens, offering large-scale laboratory facilities.
- 1957 George Granger Brown dies.
- 1959 Donald L. Katz becomes president of the AIChE.
- 1959 Donald L. Katz and colleagues publish the *Handbook of Natural Gas Engineering*.

- 1959 Lloyd E. Brownell and Edwin H. Young publish *Process Equipment Design*.
- 1959 Prof. Robert Bartels, of the Mathematics Department, is the first director of the newly created Computing Center, a position he holds for 19 years until his retirement.
- 1959 There are 38 members on our chemical and metallurgical engineering faculty.
- 1959 Donald Katz initiates a project on the use of computers in engineering education, funded to the amount of \$900,000 by the Ford Foundation—by far the largest project in our history. More than 200 faculty members from across the country participate.

1960s

- 1960 The MAD (Michigan Algorithm Decoder) programming language starts to see widespread use on the IBM 704 computer.
- 1962 Stuart W. Churchill is appointed as the fifth chairman of the department. Profs. Briggs, Carnahan, Curl, Donahue, Fogler, Goddard, Kadlec, Schultz, Wilkes, and Yeh are hired during Churchill's five-year term as chairman.
- 1966 Stuart W. Churchill becomes president of the AIChE.
- 1966 Donald L. Katz is appointed as the Alfred H. White University Professor of Chemical Engineering.
- 1967 Stuart W. Churchill leaves Michigan to accept the Carl V.S. Patterson Chair in Chemical Engineering at the University of Pennsylvania.
- 1969 The department is subdivided into two divisions. Lawrence H. Van Vlack becomes the sixth chairman of the department. Richard E. Balzhiser is appointed head of the Chemical Engineering Division.
- 1969 Brice Carnahan, James O. Wilkes, and H.A. Luther publish *Applied Numerical Methods*.

1970s

- 1971 After a liaison of 36 years, the combined Chemical and Metallurgical Engineering Department separates into two: Chemical Engineering, and Materials & Metallurgical Engineering. Chemical engineering has 17 full-time faculty members (including joint appointments), 170 undergraduates, and 55 graduate students.
- 1971 Joseph J. Martin becomes president of the AIChE.

- 1971 The IBM 360/67 computer at the U–M Computing Center has 1.5 megabytes of fast memory. The fetch and decoding time of an instruction is about 750 nanoseconds.
- 1971 Richard E. Balzhiser is appointed seventh chairman of the department, having been chairman of the ChE Division in 1970.
- 1971 James O. Wilkes is appointed as the eighth chairman of the department.
- 1971 The annual Donald L. Katz Lectureship is established, with Robert B. Bird as the first recipient.
- 1973 Undergraduate David Hammer wins the AIChE National Student Design Contest.
- 1974 Donald Katz gives his last lecture in a regularly scheduled ChE course, 19 April, and becomes an emeritus professor in 1977.
- 1975 The number of women chemical engineering students, although still relatively small, starts to rise significantly, and we have more women students than any other department in the college.
- 1975 We have our own microbiological laboratories in the new Water Resources Building on North Campus.
- 1975 In East Engineering, we have a new polymer teaching laboratory, supervised by James H. Hand.
- 1975 The enrollment in our first course, ChE 230, has risen to 180—about triple that of the late 1960s.
- 1975 Eighteen inches of snow in early December prevent several of us from attending the national AIChE meeting in Washington.
- 1975 Brymer Williams is voted chairman of SACUA—the U–M Senate Advisory Committee on University Affairs.
- 1976 At their seventh attempt, the graduate students beat the faculty at duplicate bridge.
- 1976 Robert Kadlec is appointed editor of the *AIChE Journal*.
- 1976 Staff member and accountant Madeleine Ingerson retires. She came to the department in 1951.
- 1976 A major combined \$5.5 million gift, from the Herbert H. & Grace A. Dow and Harry A. & Margaret D. Towsley Foundations, is announced—then one of the largest ever to the U–M. The Dow/Towsley gift will help to fund a new building for the department on the North Campus.
- 1977 Prof. Jerome S. Schultz is appointed as the ninth chairman of the department.

1979 Research areas now include: applied polymers (J.H. Hand), biochemical engineering (L.L. Kempe and H. Wang), bioengineering (J.S. Schultz), catalysis and spectroscopy (J. Schwank), computing & simulation (B. Carnahan and J.O. Wilkes), ecosystem simulation (R.H. Kadlec), electrochemical engineering (F.M. Donahue), heat transfer (E.H. Young), laser light scattering (E. Gulari) oil-shale research (G.B. Williams), natural-gas storage (M.R. Tek), sonochemical engineering (H.S. Fogler), and thermal properties of fluids (J.E. Powers).

1980s

1980 There are 23 members on our chemical engineering faculty.

1981 Cleatis (“Fanny”) Bolen retires as workshop supervisor after 35 years in the department.

1982 The department moves to the newly constructed Herbert H. Dow Building on North Campus, with dedication ceremonies on 15 April 1983.

1983 Donald L. Katz receives the National Medal of Science from President Reagan.

1984 The last lecture of Brice Carnahan’s popular evening lectures on computers is given in the Natural Science Auditorium.

1984 At Brymer Williams’ retirement, a significant scholarship fund bearing his name is established.

1985 H. Scott Fogler becomes the tenth chairman of the department.

1986 H. Scott Fogler publishes the first edition of *Elements of Chemical Reaction Engineering*.

1986 The department has 17 faculty and 60 graduate students.

1987 The department establishes its first graduate scholarship that is supported by annual donations from alumni/alumnae.

1989 Donald Katz dies on 29 May.

1990s

1991 Glassblower Peter Severn retires after 31 years in the department.

1991 Johannes W. Schwank is appointed as the eleventh chairman of the department.

1992 The IBM PS/2 computers in the freshman engineering laboratory have a hard-disk storage capacity of 120 megabytes and can process 300,000 floating-point operations per second.

- 1993 We are one of the three United States departments that help to establish a graduate program in the new Petroleum and Petrochemical College at Chulalongkorn University in Bangkok, Thailand.
- 1995 Ralph T. Yang is appointed as the twelfth chairman of the department.
- 1996 Brice Carnahan and James Wilkes end some 30 years of responsibility for organizing the College of Engineering freshman computing courses.
- 1996 Major research areas include biotechnology and biomedical engineering, materials and polymer processing, colloid and surface science, reaction engineering and catalysis, transport phenomena, process control and simulation, sensing and microelectronic materials, electrochemical engineering, and learning and teaching.
- 1997 The dedication of the newly furnished Walter J. Podbielniak Room is attended by his widow, Mrs. Nancy Podbielniak. A collage commemorating Walter's life is unveiled.
- 1998 On May 8 and 9, the department hosts a very successful two-day celebration of its Centennial, attended by some 250 alumni, faculty, staff, students, and friends.
- 1998 Sharon Thatcher retires as assistant to the chair after 22 years in the department.

2000s

- 2000 A portrait of Stuart Churchill at the University of Pennsylvania commemorates his 80th birthday.
- 2000 Ronald G. Larson is appointed as the thirteenth chair of the department.
- 2000 At Jim Wilkes's retirement, a significant scholarship fund bearing his name is established.
- 2001 A "blue" U-M parking permit costs \$408 for a year.
- 2001 Since 1995, several faculty hired in the 1960s have retired—Prof. Curl, Donahue, Kadlec, Briggs, Wilkes, and Carnahan.
- 2001 For 2001/2002, tuition for two terms is \$9,266 for in-state engineering seniors and \$24,250 for out-of-state seniors.
- 2002 For 2002/2003, a dormitory room and board for two terms is \$7,580 for single and \$6,366 for double occupancy.
-

Table 1—Chairmen of the U–M Chemical Engineering Department













1898–1914	Edward DeMille Campbell	
1914–1942	Alfred Holmes White	
1942–1951	George Granger Brown	
1951–1962	Donald Laverne Katz	
1962–1967	Stuart Winston Churchill	
1967–1970	Lawrence Hall Van Vlack	
1970–1971	Richard Earl Balzhiser	
1971–1977	James Oscroft Wilkes	
1977–1985	Jerome Samson Schultz	
1985–1991	Hugh Scott Fogler	
1991–1995	Johannes Walter Schwank	
1995–2000	Ralph Tzu-Bow Yang	
2000–	Ronald Gary Larson	

Table 2—Deans of the College of Engineering from 1895

1895–1903	Charles Ezra Greene
1903–1928	Mortimer E. Cooley
1928–1937	Herbert Charles Sadler
1937–1939	Henry C. Anderson
1940–1951	Ivan C. Crawford
1951–1957	George Granger Brown
1957–1965	Stephen S. Attwood
1965–1972	Gordon Van Wylen
1972–1980	David V. Ragone
1980–1981	Hansford W. Farris (<i>acting dean</i>)
1981–1986	James J. Duderstadt
1986–1989	Charles M. Vest
1989–1990	Daniel E. Atkins, III (<i>acting dean</i>)
1990–1995	Peter M. Banks
1995–1996	Glen F. Knoll (<i>interim dean</i>)
1996–	Stephen W. Director



Bill Wood

View from South University to the northwest, with West Engineering (now West Hall) and the Hatcher Graduate Library in the background.

Chapter 2

1898–1953: THE FIRST HALF-CENTURY OF THE CHEMICAL ENGINEERING DEPARTMENT

Early Interest in Industrial Chemistry†

THE University of Michigan almost from its beginning recognized the importance of teaching the applications of chemistry to industrial life. Silas Hamilton Douglas (A.M. hon. Vermont '47), who was appointed assistant in 1844, showed his interest in this subject in his *Report to the Water Commissioners of the City of Detroit on the Analyses of Waters* in 1854, in which he not only recorded the chemical composition but also discussed the relation between water supply and cholera and the danger of lead poisoning. President Tappan also was interested in the applications of chemistry. In his inaugural address in 1852 he stated:

To this end, we propose to establish a scientific course parallel to the classical course. In this scientific course a more extended study of the mathematics will be substituted for the Greek and Latin. There will be comprised in it, besides other branches, civil engineering, astronomy with the use of an observatory, and the application of chemistry and other sciences to agriculture and industrial arts, generally. (Tappan . . . , p. 40)

The title, “Professor of Metallurgy and Chemical Technology,” given Douglas during the last two years of his long career at the university, may be said to have been prophetic of the developments which were to take place in the following seventy-five years. Albert Benjamin Prescott ('64*m*, Ph.D. hon. '86, LL.D. Northwestern '03), who later became dean of the School of Pharmacy, was primarily an organic chemist, but during the period 1865–1870 he also lectured on metallurgy. Byron William Cheever ('63, '67*m*, '75*l*) was acting professor of chemistry and metallurgy from 1881 until his death in 1888, and John Williams Langley (Harvard '61, M.D. hon. Michigan '77, Ph.D. hon. *ibid.* '92) was professor of general chemistry and metallurgy in 1888–1889. The emphasis on metallurgy was due in part to the course in mining engineering which, with Cheever's appointment, was

† This chapter reproduces the article “The Department of Chemical and Metallurgical Engineering (1898–1953),” in the *Encyclopedic Survey of the University of Michigan*, Vol. VII, pp. 1190–1200 (1953), by Alfred H. White and Clair Uptegrove. Photographs have been added. The bibliography is on page 30.

divided into two options, mining and metallurgy. The last students in mining engineering were graduated in 1896, and the course was discontinued as the result of an agreement with the recently established Michigan College of Mines.

Fortunately, the professorship in metallurgy did not end with Professor J.W. Langley's resignation in 1889 nor with the discontinuing of the mining engineering course, for Edward DeMille Campbell ('86) was appointed assistant professor of metallurgy in 1890. This appointment was of great significance because Campbell brought to the university a strong interest in a field of metallurgy, which was then in its infancy, the study of the constitution of metals and alloys, particularly iron and steel. He was also much interested in the application of chemistry to industry, and this was to have its effect at an early date.

During this earlier period chemistry was relatively undeveloped, and its applications were mainly to methods of analysis. In 1892 few advanced courses were offered at the university, and almost all graduates expected to work as analysts in chemical laboratories. Analytical procedures were not well standardized, and it required originality and training to work out the problems that arose in routine analytical work. Scientific control of chemical operations was not possible until physical chemists had discovered the underlying laws which control the conditions of equilibrium and the rate of chemical reactions. This body of knowledge was developed sufficiently to be of importance in the decade 1890–1900, and this period may, therefore, properly serve as the starting point in a consideration of chemical engineering. During these years Professor Prescott was director of the Chemical Laboratory, with appointment dating from 1884. Professor Campbell gave one course in metallurgical operations, and a one-hour course entitled *Outlines of Chemical Technology* was announced as given by Otis Coe Johnson (Oberlin '68, A.M. *ibid.* '77, Michigan '71*p*), but was rarely offered. The only other courses in the applications of chemistry to industry were those in the field of analytical chemistry. Campbell was conducting research on the constitution of steel, and it was during experimental work in this subject that he lost his eyesight in the spring of 1892 (see Part III: *Department of Chemistry*).

Alfred Holmes White ('93, '04*e*) went to Europe for further study in the summer of 1896. During his stay at the Federal Polytechnicum at Zurich, Switzerland, he wrote Campbell about the courses which he taking in chemical technology and the way in which the technical work was organized. Campbell was much interested and made plans to introduce such courses at the University of Michigan. With Prescott's approval White was appointed instructor in chemical technology in 1897. The two new courses in this subject, one in inorganic and the other in organic chemical technology, were offered in alternate semesters. Campbell at that time was teaching one of the very early courses in metallography given in the United States. It is characteristic of this extraordinary man that although the subject had developed largely since his blindness, he should successfully inaugurate

without trained assistants a course in a subject requiring laboratory work.

Michigan Degree Program in Chemical Engineering

The first course in chemical engineering in the United States was offered at the Massachusetts Institute of Technology in 1888, but aroused little interest. The second was given at the University of Michigan in 1898. The *Regents' Proceedings* for April, 1898, contain a communication from Dean Charles E. Greene asking for the establishment “of a course of study in this department leading to the degree of bachelor of science in chemical engineering.” This was approved by the regents, and the direction of the course entrusted to Campbell, although no formal change was made in his title until 1902, when he became professor of chemical engineering and analytical chemistry.

The new program of study was necessarily made up of courses which were already being offered to other groups of students, because at that time the finances of the university did not permit an increase in staff or laboratories. In April, 1898, in his letter to the regents, Dean Greene stated: “No addition to the teaching force will be needed for this course,” and added, “It is not expected that the number of students will be large.” The program of study as first outlined included the fundamental courses common to all programs in the College of Engineering, one in surveying, four in mechanical engineering, one in electrical engineering, and nine in chemistry. Included in the group of courses in chemistry were two in chemical technology taught by Alfred H. White and one in metallurgy taught by Campbell; these were the forerunners of the courses in chemical engineering proper. The first class graduated with five members in 1903. By making some substitutions in their programs, Wareham S. Baldwin received the degree in 1901 and Norman Follett Harriman received it in 1902.

The requirements for graduation in the college at that time were 130 hours of credit and, in addition, a thesis. The thesis was not required after 1905, but the credit requirement in hours was increased to 140. The staff in chemical engineering considered it desirable that each student should continue to have some training in research, and introduced *Technological Chemistry 39*, a five-hour course, in which each student worked individually on a problem of his own selection and which was intended to serve as an introduction to further research work.

In the early years all the specialized courses were listed in the Department of Chemistry, but in 1908 the importance of the new department was recognized by Alfred H. White's promotion to junior professor of chemical engineering, and by the separate listing of chemical engineering courses including metallurgy in the *Announcement of the College* under their own heading and on the same basis as the courses in civil and mechanical engineering. Much credit is due Dean Cooley for this recognition; he was a firm believer in the future of the new department and prophesied that he would live to see it the largest in the college—a prophecy

which was, for a time, fulfilled.

By 1900 the old Chemistry Building was crowded, and the department had to use space wherever it could be found. The square brick tower at the east end of what is now the Economics Building contained a large tank which had held a part of the campus water supply. The basement was used as a coal bunker. This water tank was removed about 1897, and the space was made available for laboratories. The department was assigned the coal bunker, which was cleaned out and fitted up as a laboratory for gas analysis and photometry, a room on the first floor which was used as a balance room for quantitative analysis, and rooms on the second and third floors which were used for research work and metallography. The old assay laboratory in the basement of the south wing of the building was also assigned to the department.



University of Michigan Photographs Vertical file, Bentley Historical Library, University of Michigan

The "new" Chemistry Building of 1909.

The present Chemistry Building was constructed in 1909. By that time the Department of Chemical Engineering had grown to such an extent that it was graduating about twenty students a year; it was therefore allotted ample space on the first floor and in the basement of the new building. The staff in 1909 consisted of Campbell, A.H. White, and Instructor Karl Wilhelm Zimmerschied ('03, M.S. '04), who further developed the course in metallography and extended the course work in extractive metallurgy. During the next few years both enrollment and staff increased. Zimmerschied resigned in 1912 to become metallurgist for General Motors Company and, later, president of the Chevrolet Motor Company. His

place was taken by Albert Easton White (Brown '07, Sc.D. hon. *ibid.* '25), who was appointed instructor in 1911. Elmer Edwin Ware ('07*e* [Ch.E.]) came to the staff in 1909, Walter Lucius Badger (Minnesota '07, '08*e*, M.S. *ibid.* '09) in 1912, John Davison Rue (Princeton '06, A.M. *ibid.* '08), in 1913, and Clair Upthegrove ('14*e* [Ch.E.]) in 1916, all as instructors. In 1914 Campbell realized that work in chemistry and chemical engineering had increased to the point where he could no longer administer the two departments; consequently he chose to continue as professor of chemistry and director of the Chemical Laboratory, but resigned as professor of chemical engineering. The administrative direction of the Department of Chemical Engineering passed at that time to Alfred H. White, who had been promoted to a professorship in 1911.



Courtesy Judson Brown

Jack Brier and Walter Badger.

The outbreak of World War I, with consequent cessation of chemical imports from Germany and with greatly increased demand for and utilization of metals and alloys, brought widespread recognition of the value of chemical engineering and metallurgy. When the United States entered the war in 1917, the demand for trained engineers caused a depletion in the staff. The department lost five of its seven members, A.H. White, A.E. White, C. Upthegrove, J.D. Rue, and E.E. Ware, all of whom received commissions with the armed services.

These leaves of absence necessitated an almost complete reorganization of the teaching staff. Clifford Dyer Holley (Maine '00, M.S. *ibid.* '02), of the Acme White Lead and Color Works, was appointed professor of chemical engineering and head of the department on a part-time basis without salary. Professors W.L. Badger and Joseph Stanley Laird (Toronto '09, Ph.D. Princeton '12) completed the regular staff. In 1917 Assistant Professors John Crowe Brier ('12, M.S. '13), William

Platt Wood ('12, '14e [Ch.E.], M.S. '16), Instructors Clarence Frederick Smart ('16e [Ch.E.]) and Franz Perrine Zimmerli ('18e [Ch.E.], M.S.E. '19, Met.E. '34) were added. Edwin Myron Baker (Pennsylvania State '16) and Adolph Frederick Wendler ('18e [Ch.E.], M.S.E. '19) became instructors in 1918. The period of World War I was one of great activity under trying conditions. The laboratory space was inadequate, the staff was new, and the military training requirement at the university limited the time and energy that a student could give to his studies.

Crowded conditions in the Chemistry Building did not permit the development of a laboratory in unit operations or pilot processing equipment. In 1917 the Swenson Evaporator Company, of Chicago, offered to install at the university certain valuable equipment of this type free of cost if the company in exchange might employ the services of Professor Badger as a research consultant. This offer was accepted by the Board of Regents, and space was found in the abandoned Boiler House in the center of the campus for this equipment. In spite of a discouraging environment good work was done.

At the close of the war, A.H. White, A.E. White, and Upthegrove returned to the university. Holley returned to his position with the Acme White Lead and Color Works, Rue and Ware resigned, and Brier left to become superintendent of the Holland Aniline and Chemical Works. Laird was granted a leave of absence and later resigned, and Zimmerli and Wendler went into industrial work. In 1919 Eugene Hendricks Leslie (Illinois '13, Ph.D. Columbia '16) was added to the staff as associate professor. He was promoted to professor in 1923 and resigned to enter private practice in 1928. His book on motor fuels, published in 1923, was an important contribution in that field and he gave valuable assistance in graduate work. George Granger Brown (New York University '17 [Ch.E.], Ch.E. *ibid.* '24, Ph.D. Michigan '24) became instructor in 1920 and Brier returned in 1921 as professor.

Because of the demand for trained engineers and since demobilization of the armed forces left many young men without jobs, they flocked to engineering colleges in embarrassing numbers and were particularly attracted by courses in chemical engineering. In 1920–1921 more than one hundred sophomores chose chemical engineering as their field of specialization. The staff and facilities of the department were entirely inadequate to care for the load which this class represented when it reached the senior year. Fortunately, this postwar wave soon receded, but the enrollment continued much higher than before the war.

The East Engineering Building, occupied in 1923, was designed primarily to accommodate the Chemical Engineering, Aeronautical Engineering, and Metal Processing Departments. Chemical engineering and metal processing were concerned with the properties of metals, and it was arranged that the entire fourth floor should be given over to the metal processing foundry and to the laboratories devoted to metallurgy and to fuels in the Department of Chemical Engineering.

Badger's laboratory in the old Boiler House was transferred to the new Unit Operations Laboratory, a unique pilot plant installation permitting equipment to extend through three floors.



University of Michigan Photographs Vertical file, Bentley Historical Library, University of Michigan
East Engineering Building, about 1926. Can you see two Model-T Fords?

Equipment for research work in the new building came partly from university appropriations, but a much larger amount was acquired by direct gift or through the activities of the Engineering Research Institute. Contributions which have been made in this way include valuable material for determining the strength of metals at high temperatures, an x-ray laboratory with a maximum rating of 280,000 volts, high-frequency melting material, elaborate equipment for work with fuels and petroleum, a mass spectrometer, an infrared spectrometer, high-pressure equipment, catalytic pilot plants, equipment for measuring the physical properties of paper and the rate of oxidation in protective films of paint and lacquer, and a constant temperature and humidity room.

For the first fifteen years after the establishment of the department in 1898, courses in chemical engineering were concerned almost entirely with chemical and metallurgical technology and with the chemical aspects of the operation of processes. The term “unit operations” was coined in 1915 by Arthur D. Little in a report to the Massachusetts Institute of Technology: “Any chemical process, on whatever scale conducted, may be resolved into a co-ordinate series of what may be termed ‘unit operations,’ as pulverizing, drying, roasting, crystallizing, filter-

ing, evaporating, electrolyzing,” At the University of Michigan, courses in unit operations were introduced in 1915 by Badger, who offered two courses in equipment for chemical operations. Lack of textbooks hampered the development of these courses, and even as late as 1922–1923 they were announced as being “taught largely from blue prints and trade bulletins of apparatus required in many chemical engineering operations.” The appearance of *Principles of Chemical Engineering* by Walker, Lewis, and McAdams in 1923 permitted this important branch of the subject to be put on a scientific basis.



U-M Photographs Vertical file, Bentley Historical Library

Front doors of East Engineering.

The year 1925 may be considered as the end of the adolescent period in the growth of the curriculum. It also marks the acceptance of chemical engineering as a fully recognized branch of the profession throughout the United States. When the American Institute of Chemical Engineers published its first list of accredited curriculums in 1925, that of the University of Michigan was one of the fourteen recognized.

Shortly after *Principles of Chemical Engineering* was published, Badger and Baker developed a text, *Inorganic Chemical Technology*, which partly bridged the gap between the descriptive work and the quantitative viewpoint. In 1931 Badger and McCabe brought out *Elements of Chemical Engineering*, which soon became the most widely used text in this field. Minor revisions of the curriculum increased the emphasis on unit operations at this time.



Courtesy Judson Brown

A.H. White, E.M. Baker, and J. Henry Rushton, ca. 1936.

Metallurgy was first given university recognition in 1875 and continued to develop as an option in the Department of Chemical Engineering. Growth in the earlier years reflected strongly the interests of E.D. Campbell, whose work in iron and steel offered a basis for many of the developments in the field of physical metallurgy. While extractive or process metallurgy received its share of attention, interest in physical metallurgy at the university was given strong impetus by the discovery of tetragonal iron in freshly formed martensite by William Fink ('21*e*), when he was working under Campbell's supervision in 1924. Discovery of tetragonal iron represented the first significant application of x-rays to physical metallurgy. The department recognized the importance of such studies in 1929 by appointing Lars Thomassen (Norway Institute of Technology '19, Ph.D. California Institute of Technology '28) assistant professor to establish course work and laboratory in x-rays. He became professor in 1948.

With the continued growth of the department, optional course work in metallurgy increased, and the need for a greater difference in the programs of study in chemical engineering and metallurgy was recognized. The trend in this direction began in 1922, when metallurgical engineering titles were first given to those staff members working primarily in this field. In 1929 the Graduate School distinguished between the programs in chemical and in metallurgical engineering, and in 1935 a separate program was formulated in the college, leading to the bachelor's degree in metallurgical engineering. At this time the name of the department was changed to Chemical and Metallurgical Engineering.

A.H. White retired from the chairmanship in 1942 after making the department

outstanding; he was succeeded by G.G. Brown, who was also made Edward DeMille Campbell University Professor of Chemical Engineering in 1947. In 1951 Brown became dean of the college and was succeeded as chairman by Katz.



A.H. White, Clair Upthegrove, Richard Schneidewind, J.C. Brier, and E.M. Baker, chairman's office, East Engineering, ca. 1936.

A major change in the curriculums began during the period of low enrollment in World War II and continued for several years. The courses in organic and inorganic technology and the required senior thesis course were discontinued. Brown introduced thermodynamics, for many years an important graduate course, at the junior level for both chemical and metallurgical engineering students. The fuels laboratory was changed to a general measurement laboratory by Associate Professor Richard Emory Townsend ('24, M.S. '25, Ch.E. '42), who joined the staff in 1935, and Thomassen. The structure of solids as basic to engineering materials, physical metallurgy, and x-rays was introduced by Thomassen and Associate Professor Maurice Joseph Sinnott ('38e [Ch.E.], Sc.D. '46). Seniors were given process design and equipment design courses.

During this period, graduate programs in special fields of study were emphasized. A master of science degree (protective coatings) was initiated for a program built around Carrick's courses in paints, varnish, and lacquers. The basic course in engineering materials for all engineering students, in which A.H. White's book was used as a text, was combined with the metal processing shop course in 1947; staff members from both departments have co-operated in giving this instruction. Because the need for students who have broad training in chemistry as well as in engineering was recognized, a combined program between chemistry and chemical engineering was established.

Since a distinction was made between the chemical engineering and metallurgical engineering degrees in 1935 many students have received both. These students were well qualified to serve as materials engineers, especially if they elected courses

in plastics, protective coatings, and electrochemistry. A new four-year program designed to cover this field was given for the first time in 1952, with the degree bachelor of science in engineering (materials).

In 1948 the fiftieth anniversary of the establishment of the department was celebrated by a reunion of about two hundred chemical and metallurgical engineering alumni. In its fifty years the department had enrolled a total of 3,876 undergraduate students and granted 2,151 bachelor's degrees. In the Graduate School, 940 higher degrees had been granted. In 1947–1948 the teaching staff numbered twenty-five, and there were 510 undergraduate students in chemical engineering and 80 in metallurgical engineering and 197 graduate students. As of April, 1952, a total of 2,537 bachelor's degrees, 1,032 master's degrees, 9 professional degrees, and 177 doctoral degrees had been granted students from the department.

Graduate Study and Research

A program of research work was organized soon after the department was established in 1898. Campbell, who had already lost his eyesight, continued his investigations and became a world-recognized authority on steel. Programs in the constitution and properties of Portland cement and on the utilization of fuels were also instituted at an early date and continued for many years.

In 1900 the Michigan Gas Association established a fellowship in gas engineering, which is still maintained and which is the senior industrial fellowship in any of the various fields of science or engineering in the United States. A.H. White made significant contributions to the manufactured gas industry with the assistance of this fellowship.

The small group of graduate students specializing in chemical and metallurgical engineering was included with the group specializing in chemistry until 1911. The number of graduate students grew rather slowly until the close of World War I, after which there was a rapid increase.

The Department of Engineering Research, now the Engineering Research Institute, was organized in 1920. Albert E. White divided his time for a few years between teaching metallurgical engineering and guiding the new department, which has always maintained close and helpful relations with the Department of Chemical and Metallurgical Engineering.

The American Council on Education presented a report in 1934 in which universities were rated on their adequacy in staff and equipment to prepare candidates for the doctorate. The jurors were asked to star the departments of highest rank; roughly, the highest 20 per cent. The University of Michigan was one of the three universities of the United States starred as "most distinguished" in chemical engineering. The work in metallurgy was rated as "adequate."

In 1935, 20 per cent of all graduate students in the United States working toward the master's degree and 13 per cent of those studying for the doctorate in

chemical engineering were enrolled at the University of Michigan. For metallurgical engineering the corresponding figures were 25 per cent of those studying for the master's degree and 35 per cent of those working for the doctorate.

Coincident with the Depression, the graduate group in the department increased to about one hundred students, a number that has been maintained except during World War II, when as few as thirty-five students were enrolled, and in 1949, when the graduate enrollment reached a peak of 235 students. In 1932 thirty-three students were working toward the doctorate, and in the twenty years to 1952, 137 doctoral degrees were granted in chemical or in metallurgical engineering. Many of the graduate theses were on programs carried out by individual professors; others resulted from single excursions into new fields.

Petroleum. G.G. Brown, who completed his study of the utilization of natural gasoline for the Natural Gasoline Association of America in the early thirties, was familiar with the problems of the petroleum industry through his consulting connections in his field. This led him to initiate doctoral theses in the fields of pressure-volume-temperature relations of the hydrocarbons, thermodynamic properties of hydrocarbon mixtures at high temperatures and pressures, vapor-liquid equilibria at high pressure, computation of fractionating column designs, and cracking. Reports on these studies established the department's reputation in the field of petroleum and attracted students throughout the country to graduate study at Michigan. In 1936 Donald LaVerne Katz ('31e [Ch.E.], Ph.D. '33), who had been one of Brown's students and who had spent three years with the Phillips Petroleum Company in petroleum production research, joined the department. His researches in critical phenomena, surface tension, viscosity, phase behavior, gas hydrates, and reservoir phenomena complemented those of Brown, and both men were closely associated in much of their work. The "Brown Plan" of oil conservation was adopted by the Petroleum and Natural Gas Conservation Board of Alberta for the Turner Valley Field. Brown received the Hanlon Award of the Natural Gasoline Association of America in 1940, and Professor Katz was similarly honored in 1950.

Robert Roy White (Cooper Union '36, Ph.D. Michigan '41), another of G.G. Brown's former graduate students, joined the department in 1942. His interest in petroleum was directed to chemical reaction kinetics, mass transfer, and distillation. When A.H. White retired, R.R. White guided the Michigan Gas Association fellowship in the direction of fundamental kinetic studies on synthesis gas. In 1945 he received the Junior Award from the American Institute of Chemical Engineers for one of his first papers on chemical reaction kinetics, and in 1945-1946 the Russell Award of the university.

Associate Professor G. Brymer Williams ('36e [Ch.E.], Ph.D. '49) returned to the university in 1947 to assist in teaching petroleum process design and to conduct phase equilibria studies. Associate Professor Cedomir M. Sliepcevich ('41e [Ch.E.],

Ph.D. '48) joined the staff in 1946 to work in the field of reaction kinetics at high pressure. He has continued in this field and is closely associated with Professor R.R. White.



Courtesy Judson Brown

Alan Shivers Foust, who obtained his Ph.D. in 1938 on "A study of liquid velocity in natural circulation evaporators," working with W.L. Badger.

Heat transfer and evaporation. Students of Badger and Baker worked in the field of heat transfer in condensation processes and in boiling of solutions in evaporators. Badger earned a worldwide reputation as an expert on evaporation. Professor Alan Shivers Foust (Texas '28e [Ch.E.], Ph.D. Michigan '38), a student at the time Badger left the university to devote his entire attention to consulting engineering, joined the staff in 1937 and until 1952 continued work in the field of evaporation and general heat transfer.

Associate Professor Jesse Louis York (New Mexico '38, Ph.D. Michigan '50) conducted studies on entrainment in evaporation, which led into the field of analyzing sprays to determine particle sizes. In 1937 Katz began teaching heat transfer and fluid flow, which formerly had been taught by Badger. This contact with graduate students led him into a series of general researches in heat transfer. A number of reports was prepared on the subject of heat transfer through finned tubes as a result both of this general interest and of research sponsored by the

Wolverine Tube Division.

Associate Professor Warren Lee McCabe ('22e [Ch.E.], Ph.D. '28), a member of the staff from 1925 to 1936, was associated with Badger and made auxiliary studies in the field of crystallization and thermodynamic properties of caustic solutions. Associate Professor Elmore Shaw Pettyjohn ('18, M.S.E. '22, Ch.E. '30), a member of the staff from 1937 to 1942, was also interested in this area

Organic industries. About 1925 J.C. Brier became active in the field of paint and varnish production and utilization, developing methods for extracting oil from soy bean flakes. This work was interrupted when he left for active duty in the Army Ordnance during World War II. On returning to the university he engaged in research on fundamental combustion of artillery powder.

In 1945 Professor Leo Lehr Carrick (Valparaiso '11, Ph.D. Indiana '22) joined the department after spending many years at North Dakota Agricultural College. He organized a class-work program on protective coatings and engaged in research projects in the field of paints, varnish, and lacquers.



Courtesy Judson Brown

Donald William McCready. He obtained his Ph.D. in 1933, working with Warren McCabe on "Air drying of porous solids."

Associate Professor Donald William McCready (Massachusetts Institute of Technology '24e [Ch.E.], Ph.D. Michigan '33) came in 1929 as instructor. For a

time he engaged in research on drying paper, but his interest turned to plastics and polymers.

Thermodynamics. G.G. Brown organized a graduate course in the field of thermodynamics in 1923 and continued to teach it until he became dean. This background caused him to direct many students into thermodynamic problems for their research. Much of the work done in the field of petroleum was in the application of thermodynamics, as was Brown's earlier work in the field of combustion. Sliepcevich is continuing this interest, and Associate Professor Joseph J. Martin (Iowa State College '39, D.Sc. Carnegie Tech. '48), who joined the staff in 1947, is also conducting research in this field. Professor Clarence Arnold Siebert (Wayne University '30, Ph.D. Michigan '34), who joined the staff in 1936, has applied thermodynamics in the field of metallurgy. In 1939 Brown was honored with the Walker Award of the American Institute of Chemical Engineers for publications in this field.

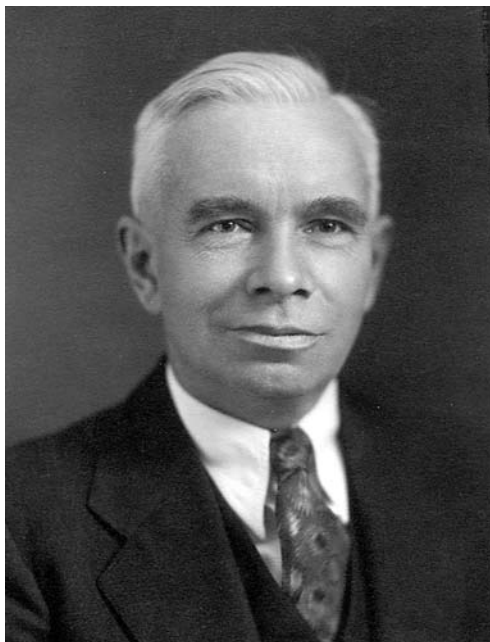

Rentschler Studio, Ann Arbor

Clair Upthegrove.

High-temperature properties of metals. Although A.E. White came to the university in 1911, it was not until after World War I that he was to engage in his research on metals and alloys at elevated temperatures, a field in which he has continued to maintain an active interest. Immediately after World War I, many questions were raised concerning the behavior of metals and alloys which would meet new and more exacting requirements, particularly those in services at high

temperatures. In 1927 A.E. White and C. Upthegrove contributed to a symposium in this field sponsored by the ASTM and the ASME and were invited to become members of the joint research committee of the two societies on metals at elevated temperatures. While some work had been done previously, this marked the real beginning of a research program under A.E. White's direction, which was to give the University of Michigan recognition throughout the world and to establish, through the Engineering Research Institute, what is today one of the largest and best equipped laboratories of this type.



James Wilkes

Close-up of the fore-hearth of the 32-in. cupola iron melting unit in the Cast Metals Laboratory, 4th floor, East Engineering Building (taken in 1967). On the left is the ladle with the tilting wheel for receiving molten iron, above is the tapping trough; in the rear center is the lower portion of the cupola furnace showing an air trunnion ring with air blast tubes feeding tuyeres into the furnace. In the upper center, a fume off-take for collecting gases released on tapping the furnace is visible.

Claude Lester Clark ('25, Ph.D. '28) and James Wright Freeman ('33, Ph.D. '40) have also contributed much to the development of this program as well as to the teaching of graduate students. Clark was concerned largely with the investigation of the fundamental effects of composition and the development of medium alloy steels for elevated temperature service. He left the university for the Timken Steel and Tube Company in 1940, and Associate Professor Freeman continued the work, with special emphasis on the fundamental factors affecting control of creep and ruptures. An extensive program sponsored by the NACA on metals and alloys for special service at elevated temperatures has been in progress since the early 1940s under his supervision.

Another phase of the behavior of metals at high temperature received attention in oxidation and decarbonization studies by Professors Wood, Upthegrove, and Thomassen, of the staff, and by Walter Edwin Jominy ('15, M.S. '16) and Donald

William Murphy (Detroit City College '28, Sc.D. '31) of the Engineering Research Institute. Studies were made of the hydrogen-oxygen-carbon-iron equilibria and of nitrogen dilution as basic information to the mechanism of scaling and oxidation. Thomassen is continuing his work in the oxidation studies of nickel chromium alloys.

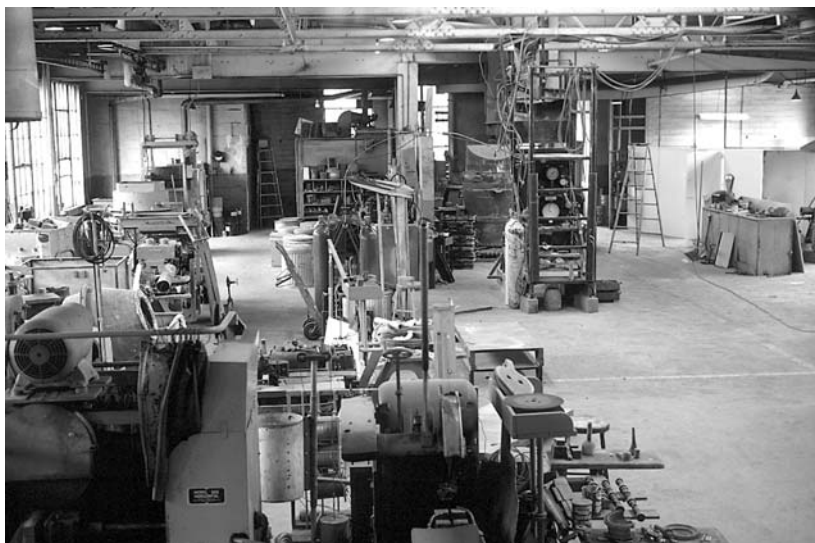

James Wilkes

View looking east in the Cast Metals Laboratory, fourth floor, East Engineering Building (taken in 1967). On the left are several gas-fired melting furnaces. In the rear, right-center, is the pulpit (gas delivery and control unit) for experiments conducted on the basic oxygen steelmaking process.

Theoretical metallurgy. In the early days departmental research in theoretical metallurgy centered almost entirely around E.D. Campbell and his studies of the constitution of iron and steel. His work was extensive, and many of his publications are to be found in the *Transactions of the British Iron and Steel Institute*. The American Society for Metals, honoring his memory, established the annual Edward DeMille Campbell lecture in 1925, the year of his death. For a time emphasis in theoretical metallurgy was shifted to the nonferrous field, although malleabilization studies continued to receive the attention of A.E. White. Uptegrove, while working in the field of metals at elevated temperatures, found other interests in recrystallization, grain growth, equilibrium studies in binary and ternary systems, and in diffusion.

In this period John Chipman (University of the South '20, Sc.D. hon. *ibid.* '40, Ph.D. California '26), who was associated with the department while in the Engineering Research Institute, became interested in the application of thermody-

namics to steel making. His work at the university established a fundamental basis for most of the studies in recent years in this field. He left the university in 1935 and became head of the Department of Metallurgy at the Massachusetts Institute of Technology. Thomassen's work in the determination of depth of cold working effects in machining, line broadening, and in the use of tracers or radioactive materials in solid diffusion represents basic investigations in these fields. Siebert has continued the work in the application of thermodynamics to metals and alloys and has indicated a growing interest in the general physical metallurgy field of iron steels. Sinnott joined the department in 1944. His teaching interest has been largely in the physics of solids, and his research with metals and high-temperature refractory materials has turned in this direction.



Richard Schneidewind and Willard Wilcox, who worked on gas hydrates with D.L. Katz and died sadly in 1938.

Cast metals. Professor Richard Schneidewind ('23, Ph.D. '33), who wrote his doctoral thesis on kinetics and malleabilization, has contributed much in the general field of theoretical aspects of cast metals. His contributions have included factors controlling austenite transformation at constant temperature and tensile properties immediately following solidification. In 1950 he was awarded the McFadden Gold Medal of the American Foundrymen's Society. Before his appointment to the staff in 1937 he conducted numerous electrochemical studies in the Engineering Research Institute.

Professor Harry Linn Campbell ('14e [Ch.E.], M.S. '21) had appointments in the Departments of Production Engineering and Chemical Engineering, bringing the practical operation of the foundry and metallurgical studies together. Professor Franklin Bruce Rote ('38, Ph.D. '44) continued in this relationship from 1946. He

was active in the development of the field of nodular iron. With Wood, he worked on pearlitic iron for surface hardening and with Upthegrove on the fracture tests for melt quality. In 1951 Professor Richard A. Flinn (City College of New York '36 [Ch.E.], Sc.D. Massachusetts Institute of Technology '41) replaced Rote. Flinn had an active interest in isothermal transformations of alloy iron and mechanisms of graphitization of gray and nodular irons.

Other research. Associate Professor Lloyd Earl Brownell (Clarkson '37, Ph.D. Michigan '48) joined the staff in 1942. He has studied flow of fluids through porous media, has had an active interest in food technology and the effect of radiation on food and drug sterilization, and has contributed to the design of chemical engineering equipment. Sliepcevich has done valuable work on light-scattering functions for the determination of particle sizes in fogs and sprays. Assistant Professor Edwin Harold Young (University of Detroit '42, M.S.E. Michigan '49), who came in 1947, has worked with Brownell on equipment design. Assistant Professor Lloyd Lute Kempe (Minnesota '32, Ph.D. *ibid.* '48) joined the staff on a half-time basis in 1952 while serving half-time with the Bacteriology Department of the Medical School. He is interested in the development of a program in bioengineering, paralleling Brownell's interest.

Staff Activities and Professional Societies

A.H. White was an early member of the American Institute of Chemical Engineers, becoming president in 1929–1930. He was active in the establishment on the Michigan campus of the first student chapter of the American Institute of Chemical Engineers in 1922, and he was president of the American Society of Engineering Education in 1942. Brown likewise was active in the institute. He was president in 1944, and over a period of years he has contributed to the work of the constitution and the education and accrediting committees. He served as director of research for the National Dairy Products, Inc., and as director of engineering for the United States Atomic Energy Commission. A.E. White was the first president of the American Society for Metals in 1920. Later, he was president of the American Society for Testing Materials.

Members of the staff have been authors of seventeen books and more than seven hundred publications. The text *Unit Operations*, prepared under the leadership of Brown, appeared in 1950 and was promptly adopted by 115 institutions, including almost all departments of chemical engineering in the country.

Alfred H. White, Clair Upthegrove

Selected Bibliography

1. *Announcement, College of Engineering* (title varies), Univ. Mich. 1906–1952.
2. *Calendar*, Univ. Mich. 1871–1914.

3. *President's Report*, Univ. Mich., 1920–1952.
4. *Proceedings of the Board of Regents . . .*, 1890–1952.
5. Shaw, Wilfred B, *The University of Michigan*. New York: Harcourt, Brace and Howe, 1920.
6. Tappan, Henry P, *A Discourse, Delivered by . . . on the Occasion of his Inauguration as Chancellor . . .*. Detroit: Advertiser Power Presses, 1852.

FACULTY MEMBERS IN 1948 (OUR 50TH ANNIVERSARY)

A news bulletin sent out by G.G. Brown in connection with the 50th anniversary of the department (celebrated on 8 May 1948), listed the faculty members shown in Table 3. The program of events is reproduced overleaf.

Table 3 Chemical and Metallurgical Engineering Faculty, 1948

George Granger Brown	Richard E. Townsend
Albert E. White (director of the Engineering Research Institute)	David W. Monroe
John C. Brier	James W. Freeman
Clair Upthegrove	Franklin B. Rote
William P. Wood	Maurice J. Sinnott
Donald L. Katz	Lloyd E. Brownell
Richard Schneidewind	Joseph J. Martin
Leo L. Carrick	Charles M. Moesel
Lars Thomassen	Julius T. Banchero
Donald W. McCready	J. Louis York
Clarence A. Siebert	Cedomir M. Sliepcevich
Alan S. Foust	Brymer Williams
Robert R. White	John E. Myers
Edwin H. Young	Charles M. Thatcher

1898	1948	1948
<p>Saturday Morning</p> <p>Open House</p> <p>Department of Chemical and Metallurgical Engineering</p> <p>The Staff</p>	<p>Saturday Afternoon</p> <p>4:00 P.M.</p> <p>Auditorium of the College of Architecture</p>	<p>Saturday Afternoon</p> <p>4:00 P.M.</p> <p>Auditorium of the College of Architecture</p>
<p>Saturday Noon</p> <p>1:00 P.M.</p> <p>Luncheon</p> <p>MENU</p> <p>Fruit Cocktail</p> <p>Pot Roast of Beef, jardiniere</p> <p>Oven Brown Potatoes</p> <p>Peas</p> <p>Rolls</p> <p>Cherry Pie</p> <p>Coffee</p> <p>Alfred H. White, Presiding</p> <p>Before the Days of Chemical Engineering</p> <p>E. C. Sullivan</p> <p>Introduction of Alumni and Friends</p> <p>The University's Position in our Advancing Technology</p> <p>S. D. Kirkpatrick</p>	<p>Saturday Noon</p> <p>1:00 P.M.</p> <p>Luncheon</p> <p>Michigan Union</p> <p>MENU</p> <p>Fruit Cocktail</p> <p>Pot Roast of Beef, jardiniere</p> <p>Oven Brown Potatoes</p> <p>Peas</p> <p>Rolls</p> <p>Cherry Pie</p> <p>Coffee</p> <p>Alfred H. White, Presiding</p> <p>Before the Days of Chemical Engineering</p> <p>E. C. Sullivan</p> <p>Introduction of Alumni and Friends</p> <p>The University's Position in our Advancing Technology</p> <p>S. D. Kirkpatrick</p>	<p>Geo. Granger Brown, Presiding</p> <p>Greetings from President Alexander G. Ruthven</p> <p>Chemical Engineering's Dimensions</p> <p>Dr. Willard H. Dow</p> <p>Remarks by</p> <p>Dean Ivan C. Crawford</p> <p>New Horizons for Chemical Engineering</p> <p>Regent Ralph A. Hayward</p>
1898	1898	1948

Chapter 3

EARLY PIONEERS: CAMPBELL AND WHITE

CHEMICAL ENGINEERING BEGINS AT THE UNIVERSITY OF MICHIGAN

THE following excerpt is taken from pages 212/213 of the *Proceedings of the Board of Regents* for 22 April 1898, and clearly establishes a degree program in chemical engineering at the University of Michigan.

“ . . . Regent Dean presented and read the following communication from the Dean of the Engineering Department, and the course of study outlined therein was approved by the Board.

ANN ARBOR, APRIL 20, 1898.

TO THE HONORABLE, THE BOARD OF REGENTS OF THE UNIVERSITY OF MICHIGAN:

GENTLEMEN: The faculty of the Department of Engineering would respectfully ask your approval of a course of study in this department leading to the degree of Bachelor of Science in *Chemical Engineering*.

The proposed work is as follows, as now required of Mechanical Engineering students:

FRENCH AND GERMAN—Fifteen hours.

ENGLISH—Four hours.

MATHEMATICS—Thirteen hours.

PHYSICS—Ten hours.

DRAWING—Nine hours.

SHOP PRACTICE—Four hours.

METALLURGY—Three hours.

PHYSICS—Laboratory, three hours.

SURVEYING—Use of Instruments, one hour.

Required of Civil Engineering students.

MECHANICAL ENGINEERING—Mechanism, two hours.

MECHANICAL ENGINEERING—Dynamics of Machinery, one hour.

MECHANICAL ENGINEERING—Engines and Boilers, three hours.

MECHANICAL ENGINEERING—Hydraulic Machinery, two hours.

ELECTRICAL ENGINEERING—Dynamamos, three hours.

Also required for the Chemical Engineering degree.

CHEMISTRY—Qualitative Analysis, ten hours.

CHEMISTRY—Quantitative Analysis, seven hours.

CHEMISTRY—Advanced Quantitative, five hours.

CHEMISTRY—Organic, five hours.

CHEMISTRY—Organic Preparations, two hours.

CHEMISTRY—Gas Analysis, one hour.

CHEMISTRY—Chemical Technology, five hours.

CHEMISTRY—Organic Technology, five hours.

CHEMISTRY—Special Work, five hours.

Amounting in all to *one hundred and eighteen hours* of required work, and leaving *twelve* hours for electives.

If *nine* elective hours are devoted to additional Mathematics and *two* hours to Resistance of Materials, a fifth year will enable the student to carry on Machine Design and broaden in Mechanical Engineering.

No addition to the teaching force will be needed for this course.

Professor Prescott heartily endorses this proposed course of study and states that inquiries for such a course, and for students who have had such training, are made from time to time. It is not expected that the number of students will be large.

A similar course is now offered at the Massachusetts Institute of Technology.

Respectfully submitted.

Chas. E. Greene,
Dean of Dep't of Eng'g."

EDWARD DEMILLE CAMPBELL

by Alfred Holmes White†

WITH the death of Edward DeMille Campbell there passed a man whose indomitable optimism and courage had enabled him to triumph over a tremendous handicap and win for himself an international reputation as a scientist. Blinded when only twenty-eight years old, he continued his chosen career and not only fulfilled his duties as a teacher and administrator for thirty-three years, but published seventy-seven contributions to the research literature of his profession.

He came from a distinguished family, his father having been a justice of the Supreme Court of Michigan for thirty-seven years and, to a large extent concurrently, a professor in the Law School of the University of Michigan for twenty-six years. Edward was born on September 9, 1863, in Detroit, at that time more a country town than a city, was educated in the public schools, and in due time entered the University of Michigan. He was fond of hunting and his scientific tendencies let him into a study of zoology, which he was tempted to adopt as his profession. Chemistry exercised the stronger attraction, however, and metallurgy became his chosen subject. During his senior year in college he was assistant to Prof. Byron Cheever and published his first research paper on "A Colorimetric Process for Estimating Phosphorus in Iron and Steel."

The four years following graduation were spent at isolated blast furnaces where he was the only technical man. Even under those conditions he found time to continue his research work, and two papers continuing his analytical studies on the determination of phosphorus in steel appeared in 1887 and 1888. Professor Cheever died in 1888 and, after canvassing the field for a year, the University of Michigan called Professor Campbell to be assistant professor of metallurgy in charge of the courses in quantitative analysis, assaying, and metallurgy.

With his acceptance of a university career he commenced to plan a definite research program and took up the question of the causes of hardening of steel. One of the lines of approach which seemed promising was the identification of the hydrocarbon gases evolved on solution of a steel which had been subjected to specific heat treatment. It was necessary to eliminate the large excess of hydrogen, and this was done by fractional combustion of the gases with oxygen by means of palladium black contained in a capillary tube immersed in ice water. One day the combustion was proceeding normally under the direction of an assistant when Professor Campbell entered the room and stooped to examine the apparatus closely. At that moment an explosion flashed back through the capillary tube to the glass gas holder and Professor Campbell never saw again. The accident happened three days before the spring vacation of 1892. Ten days later, with the

† Reprinted from *Industrial and Engineering Chemistry*, Vol. 17, No. 11, page 1204, November 1925. Originally published by the American Chemical Society.

reopening of school, he was back at his desk, a broad white bandage over his eyes, conducting classes and supervising laboratory work.



Edward DeMille Campbell.

His life soon became ordered to the new conditions—a daily hour of physical exercise in the gymnasium, hours when assistants read to him, the preparation of notes written by himself with the Braille typewriter, and many hours of planning. It was this latter element which permitted him to obtain his remarkable success as an investigator, utilizing the hands and eyes of those who were frequently merely undergraduates. No research problem was undertaken unless it could be planned so that the variables could be measured quantitatively and little be left to the uncertain judgment of the experimenter. He developed his memory marvelously. He would take the results of experimental work day by day, make approximate mental calculations, and visualize the trend of a series of tests in a way which was extraordinary. He once said that he aimed to know more about each student's work than the student did himself, and he did.

He remained at the University of Michigan from 1890 until his death. The

growth in numbers of students and staff, with consequent differentiation in duties, brought about various changes in his titles. He organized the course in chemical engineering in 1902 and held that professorship among his other titles for twelve years, and was director of the Chemical Laboratory from 1905 until his death. In his later years he gave up lecturing, giving his time to administrative duties and his research students.

Professor Campbell's research papers fall into three groups: twenty-three titles in analytical chemistry, mainly of steel, forty titles on the correlation of the chemical and physical properties of steel, and fourteen on the constitution of Portland cement. They represent a mass of solid contributions, and in spite of the difficulties surrounding their production, only one, an early paper which Professor Campbell himself withdrew, has revealed an unsubstantial basis. This does not mean that there has not been controversy over theoretical deductions, but even there Professor Campbell held his own with at least creditable frequency and was rarely, if ever, distinctly defeated. One of the pleasures which came to him rather early in his career was the frank acknowledgement of Prof. John Oliver Arnold of Sheffield, in a paper in the *Journal of the Iron and Steel Institute* in 1899, when after repeating Professor Campbell's work on the diffusion of sulfides in steel, he said, "the authors have the utmost pleasure in directly confirming the accuracy of Professor Campbell's general conclusion, and here congratulate him upon an important discovery in metallurgical physics, so remarkable and unexpected as to have been received with general incredulity."

A great sustaining factor in Professor Campbell's life was his family. He married Jennie M. Ives of Cincinnati in 1888 and is survived by her as well as by his six children and seven grandchildren. He maintained his contact with literature, music, and people. He enjoyed the several clubs to which he belonged and though he must often have felt discouraged he never displayed anything but genial cordiality and optimism. The approach of deafness was slowly walling him in still further, but it did not conquer his spirit. His death on September 18, 1925 came a few days after an operation from which he seemed to be rallying well. He had lived an extraordinary life and leaves a record of achievement granted to but few.

In a letter of 29 October 1969 to Larry Van Vlack, Walter E. Jominy (see p. 27) wrote: "Yes, I was Prof. Campbell's assistant during the school year 1915-1916. I did Campbell's research work during this period and got a great deal out of it. The job took all my time from 8 till 5 except when I attended class. It was my job to call at Campbell's house at about 8 in the morning and read the *New York Times* to him. I would read the headlines and he would say whether to read the article. We always read all the editorials and other important articles. World War I was on but the U.S. was not yet in it. Campbell followed every activity of the war. After reading the paper I would lead him to his office in the Chemistry Bldg. where he would conduct the business of the Chemistry Department. Also had students come in and read technical articles to him and discuss them with him for which the student got one hour's credit. Whenever Campbell was free he would come out into the lab where I was working and discuss the experiments I was carrying out for him. He had a marvelous memory and knew exactly where his equipment was. For instance if I needed to use a platinum electrode he would tell me to go to a certain closet—maybe on the top shelf behind a large porcelain tube—and sure enough there it would be. Then I would have to put it back in the same place after I finished with it, and then I would have to lead him to the same spot and let him feel it and the surroundings. He knew where every gas line, water line, hydrogen sulphide line, drainage pipe, etc. in the Chemical Bldg. was located—in fact he told me he laid out the Chem Bldg. before it was built.

AMERICAN CONTEMPORARIES—ALFRED HOLMES WHITE
by Warren L. McCabe

*Reprinted from News Edition, INDUSTRIAL AND ENGINEERING CHEMISTRY, Vol. 17, Page 607, September 20, 1939
Originally published by the American Chemical Society*

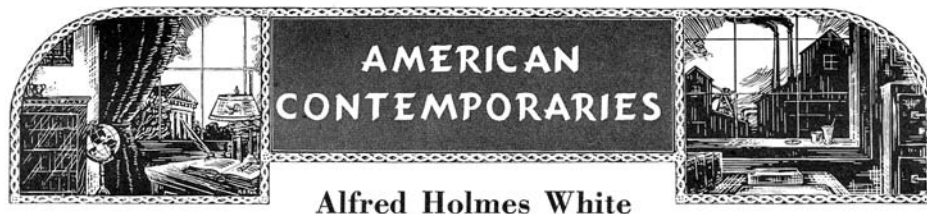

ALFRID Holmes White, educator, chemist and chemical engineer, is a native of Peoria, Ill. His parents were Samuel Holmes White and Jennie McLaren. The tall, white-haired gentleman, known to many generations of University of Michigan students, seems to most of them to be such an integral part of the university that it is not easy to realize that Professor White studied, or did early teaching, at McGill University, Montreal; at the University of Illinois; and at the Polytechnicum, Zurich, Switzerland, where he did graduate study under Lunge.

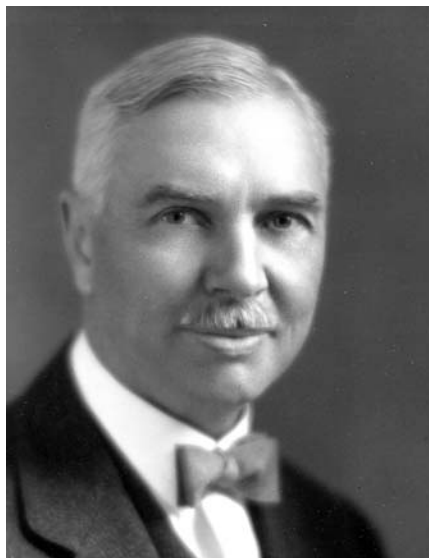

Rentschler, Ann Arbor

Alfred Holmes White, 1929.

His A.B. degree, it is true, was received at Michigan, but it was not until several years later, in 1897, that he began his long career at Ann Arbor, where he became instructor in chemical technology, his subject of specialization at Zurich. Professor White's collegiate training was in the classics and in chemistry, chemical engineering being at that time unknown.

In the summer of 1898, Alfred White, with several other young men, made a trip to the Klondike. One gathers that no great amount of gold was found, but that quite a summer was had—a summer which was decidedly nonacademic.



Apostles Club records, Bentley Historical Library, University of Michigan

The original 12 Apostles watch John A. Fairlie (left) and Eugene C. Sullivan play chess. Surrounding the players are (L to R) Walter B. Escott, Alexander Ziwet, Alfred Holmes White, Walter B. Pillsbury, George Hulett, John S.P. Tatlock, Max Mikler, H.D. Carrington, Isaac Newton Demmon, and Frederick Dunlap. The photograph is from 1900 or 1901.

During his early years at Michigan†, the young instructor was associated with Edward DeMille Campbell, Albert B. Prescott, Otis C. Johnson, and—as more nearly a contemporary—with Moses Gomberg. All of these men influenced Alfred White’s scientific outlook and career. His early work on Portland cement was done with Professor Campbell, and from this same remarkable personality his interest in metallurgical subjects stems. During the pre-war period, Professor White moved through the usual academic grades of instructor, assistant professor, professor, and, since 1914, head of the Department of Chemical Engineering.

† *Michigan Today*, Summer 2000, page 20, says of the above photograph: “The Apostles club, which existed from 1900 to 1943, was an organization for bachelors on the University of Michigan faculty. Members fitted as many as possible into the boarding house they lived in, while the rest roomed nearby. They kept membership low, somewhere in the teens, so that all could eat around the same table. Besides eating and sleeping, the group admitted to a third purpose, “recreating,” as it was called in their bylaws. They amused themselves in a range of activities from playing baseball against a team known as the ‘HPH’ (henpecked husbands) to formal dances to hosting parties known as ‘At Homes.’ Ann Arbor was a small town in those days (fewer than 15,000 residents when the club formed), and society more rigid and formal. By joining together, the Apostles could hold a position in society without the expense of trying to run a house by themselves on a junior faculty salary.”

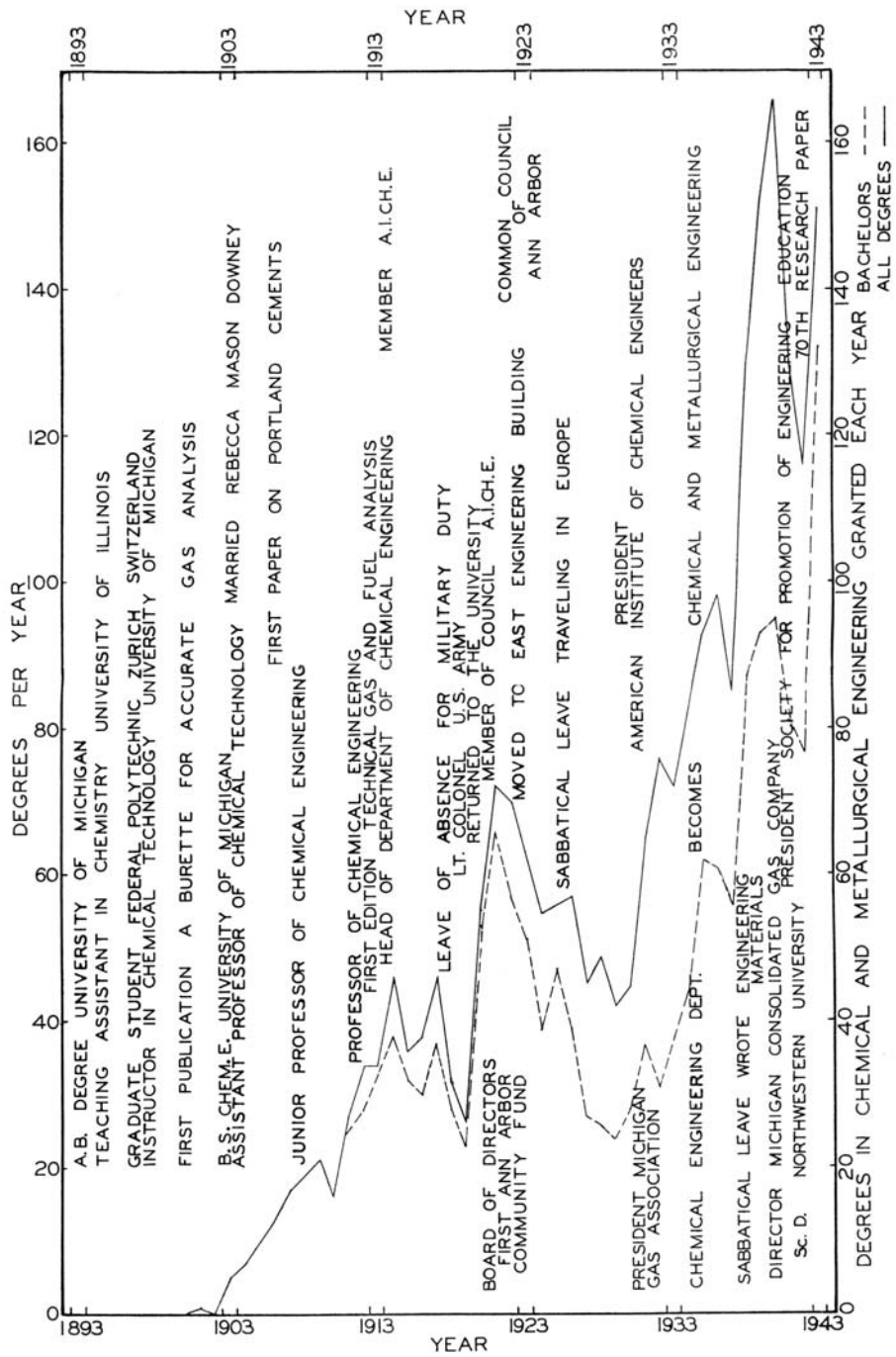

Development of Chemical and Metallurgical Engineering Under Professor White's Leadership.

The academic titles so listed indicate in a general way the development of chemical engineering at Michigan. A chemical engineering curriculum was set up at Michigan in 1898, located in the Engineering Department, although the training given in the course was predominantly chemical. In this point, it may be of interest to note the prediction made at the time to Professor White by Mortimer E. Cooley; namely, that A.H. White would see the day when chemical engineering would constitute the largest engineering branch at the University of Michigan. Some 35 years later, both Professor White and Dean Cooley saw the prediction verified; the reader can rest assured that the fact was duly noted by both men.

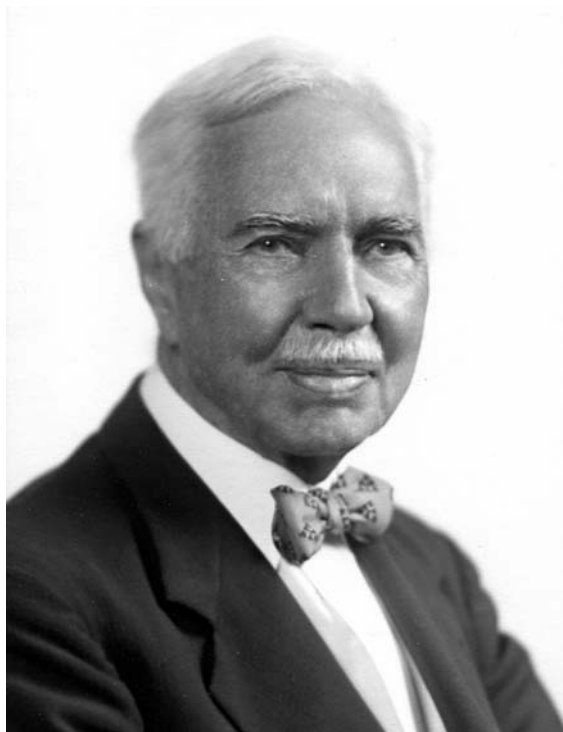

Rentschler, Ann Arbor

Alfred H. White, May 1953.

As chemical engineering grew, and as the program of training developed, Professor White accepted greater and greater proportions of the responsibility of the course and, in 1914, became head of the Chemical Engineering Department, taking over the leadership from Professor Campbell, who, in turn, completed his career as the director of the Chemical Laboratory.

During the entire history of the Chemical Engineering Department, metallurgy has been associated with it, first under Campbell and later under A.H. White.

During the leisurely pre-war days at Ann Arbor, Professor White carried out fundamental work on Portland cement, and gas and fuel analysis. Perhaps his

best known and most important work on Portland cement was his demonstration of the net volume increase of Portland cement resulting from alternate wetting; test bars representing a wide variety of cement types and mixes were prepared with glass-end plates allowing accurate measurement of length. The data obtained from the periodic measurement after controlled wetting and drying of these bars during more than 30 years have shown the importance and extent of volume changes in Portland cement.

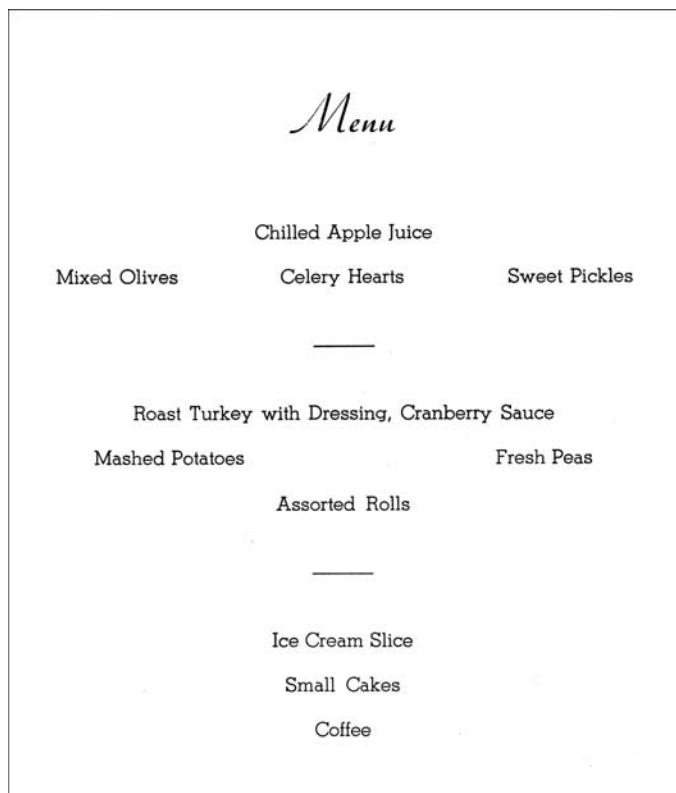

The menu for the dinner at the Michigan Union, honoring A.H. White on his 70th birthday, 29 April 1943.

In reviewing Professor White's career, it is noticeable that the World War of 1914–1918 formed a pivotal point. The war brought him suddenly into a type of activity which differed from anything he had known before. Early in the emergency, he applied to the War Department for a commission and was appointed a captain in the Ordnance Department and first assigned as head of the Metallurgical Branch of the Inspection Section of the Gun Division. He held that post until the middle of September 1917, when he was transferred to a new division (Division T) created to take care of the production of raw materials for explosives. He became technical

advisor to the military head of the department, Colonel J.W. Joyes. He was stationed in Washington throughout the war and acted as technical director of the Nitrate Division. He had great influence in the development of the plans, processes, and operations of the Muscle Shoals Nitrate Plants in Alabama. He was at first commissioned captain, but later became a lieutenant colonel.

Colonel White held a position of considerable authority in the Nitrate Division. The \$100,000,000 industrial effort to be put through in rush time was, of course, no easy task. There were necessarily entanglements with other branches of the War Department, there was red tape to be cut, and a large organization to be kept in line. The colonel also had to act as a buffer between the military organization above him, and the nonmilitary, highly trained technical men, who did not always respond to military restrictions, below him. The plants were constructed in record time and operations were started at the time of the Armistice.



Mary Julian White (left), with her parents, Alfred and Rebecca White, on their 50th wedding anniversary, July 28, 1953.

From the associates of Professor White who knew him before and after war days, the writer has received the impression that his Washington experiences did result in a moderate and conservative extension of the White vocabulary, and,

more important, brought to him an appreciation of the importance of engineering factors in the large-scale operation of processes.

The writer first saw Colonel White on his return from the war. The initial impression of an urbane, dignified, genial gentleman was intensified by the fact that the colonel was still in uniform. Professor White's post-war associates and students undoubtedly have these same impressions. He seems to be on a permanent plateau as far as age is concerned. Recently the alumni of the Chemical Engineering Department of the University of Michigan had his portrait painted.

Since the war, Professor White has not only witnessed the growth of modern chemical engineering generally, but under his administration his own department has developed in size and reputation to front rank. The great increase in graduate work, the emphasis on research, the close contacts with industry, are all important basic principles that have been operative in the development of his department. Professor White has during this period been influential in the policies of the Engineering College as a whole.



Alfred and Rebecca White on their 50th wedding anniversary, July 28, 1953.

Since the inception of the Department of Engineering Research, which is a successful agency in correlating the industrial research work in the Engineering College, he has been one of its most active supporters and has had a great influence on its policies and progress.

Much of Professor White's post-war professional activity has been centered around the American Institute of Chemical Engineers, which owes a great deal to the time, thought, and energy he has devoted to its affairs. A member of the

institute since 1914, he served as director in 1922 and 1923; as vice-president from 1924 to 1928; and as president in 1929 and 1930. The first student chapter of the institute was formed under the guidance of Professor White at Michigan in 1922.

Professor White's personal and home life has been that of a cultured gentleman and good citizen. He served as a member of the Ann Arbor City Council; he has taken a lifelong interest in civic, state, and national affairs. His hobbies have centered around reading and gardening. His fund of quiet good humor makes him an excellent companion. He married Miss Rebecca Mason Downey, of Pueblo, Colo., in 1903. The home life of Alfred and Rebecca White has centered around two children: the late Dr. Alfred McLaren White, whose untimely death in 1936 cut short a career well started; and Dr. Mary Julian White, a practicing New York physician. A.H. White died in his East Engineering office on 25 August 1953, within a month of his 50th wedding anniversary.



U-M Information Service

Donald L. Katz

Paul Jaronski

John W. Halloran

A.H. White Professorships. Such was the influence and reputation of A.H. White that two faculty members subsequently included his name in their titles:

1. Donald L. Katz, A.H. White University Professor of Chemical Engineering (1966). At the time of this recognition, there were only twelve such distinguished university professorships at the University of Michigan. A detailed biography of Prof. Katz appears in Chapter 5.
2. John W. Halloran, Alfred Holmes White Collegiate Professor of Materials Science and Engineering (2001). Professor Halloran received his B.S. degree in ceramic engineering from the University of Missouri-Rolla and his Ph.D. in materials science and engineering from the Massachusetts Institute of Technology. He joined the Materials Science and Engineering Department in 1990.

ALFRED HOLMES WHITE—A 70TH BIRTHDAY TRIBUTE

by Sidney D. Kirkpatrick†

JUST about a year ago I made my maiden appearance on a banquet program of the great Engineering Institute of Canada. Then, as now, I found myself pretty well down on the long list of more distinguished speakers who were there to represent the various engineering societies of the United States. I recall that Professor White spoke as president of the SPEE‡, followed by Dean Knipmeyer as president of the NCSBEE, followed by each of the presidents of the older and so-called “founder” societies. Each rather eloquently, and I thought quite adequately, extended the hand-across-the-border greeting so appropriate for such an international occasion. By the time they got to me, however, there seemed very little to say, at least on that score. So I chose to speak as a representative—not as one of the great founders—but as a mere “foundling” among the engineering societies.

I told them how in the year 1888, chemical engineering, as a crying infant, had been left in a basket on the doorstep of that great Temple of Knowledge on the old Charles River in Cambridge, which is known as the Massachusetts Institute of Technology. As usual, in such cases, there probably were some slightly indelicate questions raised regarding the parentage of the infant. Some there were who claimed that the father was mechanical engineering, who then even as now was oft-times inclined to stray away from the straight and narrow path. There seemed to be no doubt about the other parent—in fact, there were many who referred to the little visitor as a “strange and mulish hybrid,” sired by engineering and damned by chemistry. Be that as it may, the simple truth of the matter is that the early days of chemical engineering at MIT were far from pleasant.

The first graduates were supposed to be mechanical engineers with some acquaintance with the applications of chemistry in the arts. Unfortunately, as the late Dr. Arthur D. Little often remarked—the first chemical engineers had only a “bowing” acquaintance with chemistry.

It remained for the University of Michigan in 1898 to establish a chemical engineering program on a sounder basis. This course had the advantage of being located in the Engineering Department, but in contrast with the situation at Cambridge, it was launched with the hearty cooperation of the Chemistry Department. Michigan was also most fortunate in having on its staff a young instructor who had just returned from three years of study at the Federal Polytechnic Institute

† Prepared for the 70th birthday banquet of A.H. White, 29 April, 1943, Ann Arbor. Sid Kirkpatrick had recently been president of the AIChE and was also editor of the McGraw-Hill journal *Chemical and Metallurgical Engineering*, later renamed *Chemical Engineering*. He was remembered by Barbara Everitt Bryant (as of 1998 an adjunct research scientist in the U-M School of Business Administration), who directed the 1990 Census of the United States, and whose father had been dean of the College of Engineering at the University of Illinois.

‡ Society for the Promotion of Engineering Education, later to become the American Society for Engineering Education.

in Zurich, and who was ready and anxious to take hold and grow up, so to speak, with chemical engineering education.

Alfred H. White has been growing up with chemical engineering education ever since. He has seen chemical engineering grow from the smallest to the very largest branch of engineering at Michigan. He has seen it grow on a national scale until it has become second only to mechanical engineering in undergraduate enrollment and to lead all others in graduate study. During all this time he has been an acknowledged leader in his chosen field. We, who have followed along the trail he has pioneered, owe him a tremendous debt.

My first personal contact with our honored guest was just about 25 years ago—almost to the month. It was in the spring of 1918 in Washington and he was then a captain or a major in ordnance, and head of a new division charged with the production of raw materials for explosives. I was working for the government as a civilian, but I too wanted a commission in ordnance. When I was ushered into the office of the chief, I came face to face with a tall, gray-haired distinguished-looking officer. For the moment I thought it was Jim White, the supervising architect at the University of Illinois, but I quickly discovered my mistake and realized that I was in the presence of his younger brother. We had a pleasant meeting and while I didn't get the job I wanted, I gained a friend who in succeeding years has meant a great deal to me.

Our next association came in June, 1921, when the American Institute of Chemical Engineers met in Detroit. We all had a hand in launching the work of the Arthur D. Little Committee on Chemical Engineering Education that was eventually to lead to the institute's accrediting program, which in turn became the accepted pattern for ECPD†. In 1922, Michigan and White pioneered again with the establishment of the first student chapter of AIChE on any university campus throughout the United States. Now I judge there must be more than 80, for I myself had the privilege of installing the 79th at Tufts College on St. Patrick's Day in 1942.

At the Providence meeting in 1925 a small group of teachers and industrialists got together at a round-table and decided that chemical engineering had finally reached the age when it was entitled to a book literature of its own. Conflicting conceptions of the subject had gradually disappeared as chemical engineering was generally accepted as a specific branch of engineering. From this meeting emerged the plans, in September 1925, for the Chemical Engineering Series of Text and Reference Books that now includes more than twenty titles, from which several hundred thousand volumes have already been printed, not only in English but in French, Russian, and I am sorry to say in German and Japanese. Professor White, whose first McGraw-Hill book was published in 1913, and whose *Engineering Materials* is now one of our best sellers, has been a member of the advisory committee

† Engineering Council for Professional Development.

for the Chemical Engineering Series since its inception.

Back in 1932, when we were in the trough of the Depression and some of us thought that we might encourage a better understanding of the work of the chemical engineer were we to accord public recognition from the coordinated group efforts of chemical engineers. Professor White contributed constructively in all of our thinking and planning. As a result he has been the only chemical engineer who has served as a member of each of the five different award committees. He was our unanimous choice for chairman of the 1941 committee made up of the heads of chemical engineering in all of the 40 accredited educational institutions of the country. On December 2, 1941, five days before Pearl Harbor, Professor White had the very great pleasure and unique privilege of presenting the fifth of these awards to his former student, Willard H. Dow, whom he had watched with interest and pride as he had grown to guide that great Michigan enterprise to a leading position among the chemical industries of the world.

On June 16 of last year, Mrs. White and I—as well as three or four thousand other people, sat in the hot sun out on the steps of the new Technological Institute of Northwestern University in Evanston, and listened politely, I hope, while the Honorable Jesse Jones[†] read, with some difficulty, his long dedicatory address. At this moment, I can't remember a single thing he said, but I shall never forget the impressive ceremony that followed in the awarding of the honorary doctor degrees. The event that interested us most was when a tall, handsome and distinguished gentleman, with his academic cap tilted at a slightly jaunty angle, walked briskly up to the platform and was cited to President Snyder as “Alfred Holmes White, a great educator in the field of chemical engineering.” Those simple words, coming with that honor so long overdue, impressed me tremendously—a great educator in the field of chemical engineering, a great chemical engineer, a great friend, that truly great man we honor tonight.

[†] Jesse Jones was a Texan who was prominent in FDR's New Deal, and was head of the Reconstruction Finance Corporation.

OTHER ARTICLES RELATING
TO THE FIRST 50 YEARS

WHAT MICHIGAN OFFERS THE
GRADUATE CHEMICAL ENGINEER

by Walter L. Badger†

THE profession of the chemical engineer is becoming so complicated that a four-year course is quite inadequate training for a man who hopes to hold positions of responsibility or to make any appreciable contributions in his chosen field. This is not an academic point of view, since the majority of requests which are made by employers are for men with graduate training. In recent years there has also been a noticeable demand for men with a Ph.D. degree in chemical engineering. It is a further healthy sign of the conditions in the profession that employers are, in general, willing to pay larger salaries for men with these advanced degrees. Accordingly, a prospective student may look on postgraduate training as an investment which will return to him many times its cost during his first five years out of school.

The Department of Chemical Engineering at the University of Michigan has recognized this trend for some time and has been shaping the work it offers to meet this demand. The ordinary four-year undergraduate course is designed so far as possible to give a man a sound foundation and also a broad view of his profession, but it is impossible to accomplish any specialization in a four-year course and at the end of it secure positions of usefulness and interest, although they cannot hope for as rapid promotion as men with graduate training.

The four-year course includes the usual foundation in mathematics, physics, chemistry, mechanics, modern language, English, the elements of mechanical and electrical engineering, and basic courses in chemical engineering. These basic courses include a general survey of engineering materials, a more detailed study of the properties of metals, a general survey of the unit operations, and a discussion of the more important inorganic and organic chemical industries. This does not

† *Chemical & Metallurgical Engineering*, Vol. 36, No. 3, 139–141 (1929).

deviate much from the courses generally offered in chemical engineering, except in the emphasis which is placed on unit operations.

Metallurgy has always been a part of chemical engineering at the University of Michigan, although the emphasis has been placed on the working of metals rather than on the extraction of metals from their ores. In the last year of undergraduate work a man who is interested in metallurgy deviates somewhat from the course outlined above, but he is distinguished mainly by the fact that he chooses his thesis problem in a metallurgical subject.

For many years one important feature of the undergraduate work in this department has been the thesis. It has been considered that if a chemical engineer is to accomplish anything in his profession it will be by solving new problems. Based on this point of view, the department has not offered many laboratory courses involving fixed sets of experiments, but has always laid considerable emphasis on the thesis. It is not expected that the average undergraduate can uncover any appreciable amount of new information; but he can take a problem, review the literature, plan experimental work, design apparatus and, in general, learn the technique of research work, even though he does not go much farther.

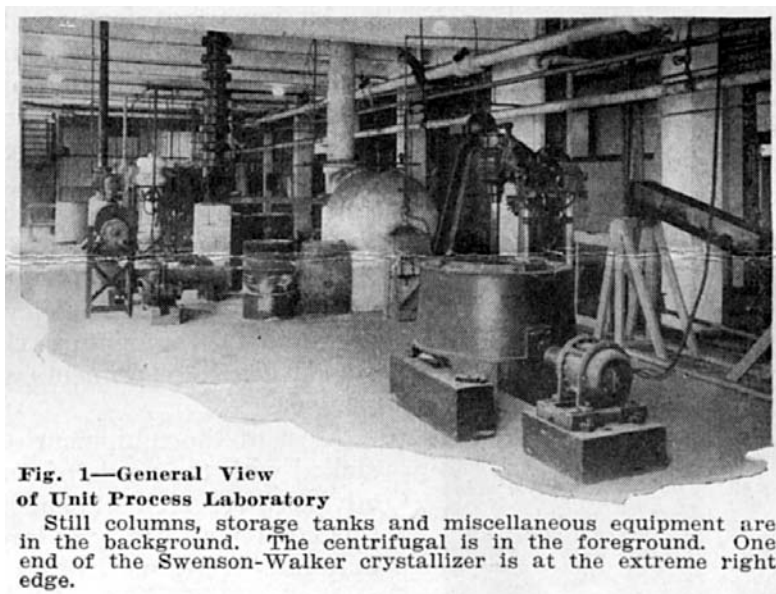

**Fig. 1—General View
of Unit Process Laboratory**

Still columns, storage tanks and miscellaneous equipment are in the background. The centrifugal is in the foreground. One end of the Swenson-Walker crystallizer is at the extreme right edge.

Since the undergraduate thesis has been of prime importance for many years, it was natural that graduate work developed early at the University of Michigan. The principal growth along these lines has come since the war, and at present there are 41 graduate students enrolled in the Department of Chemical and Metallurgical Engineering, of whom 23 already have the master's degree are working for the doctorate. The work of these graduate students follows naturally along the lines of the undergraduate courses.

Chemical engineering as we view it, is really based more on mathematics and physics than it is on chemistry; therefore the graduate students generally do not take courses in chemistry unless they are especially interested in the chemical rather than the engineering side of the profession. On the other hand, practically all of them take advanced work in physics, mathematics, and thermodynamics, advanced courses on the unit operations, some advanced courses relating to specific industries, and considerable research work. A candidate for the master's degree usually accomplishes something definite in the way of results from his research; and the candidates for the doctor's degree are, of course, held to the standard of making some definite contribution to knowledge.

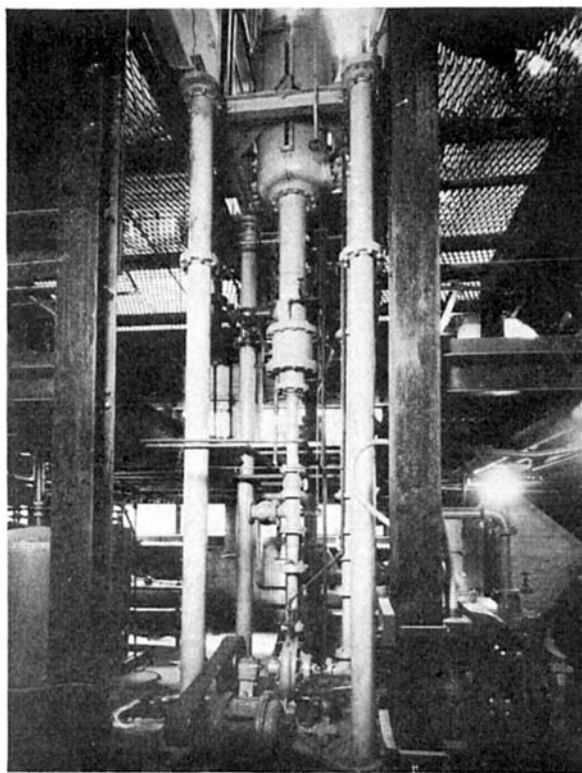

Fig. 2—Model Forced Circulation Evaporator
One of the experimental evaporators with a few of its connections.

The importance of postgraduate work, both from the standpoint of the results obtained from the investigations and from the standpoint of supplying especially trained men for the industries, is emphasized by the number of industrial fellowships which are available. During the school year of 1928–1929 there are available the following: the Michigan Gas Association fellowship, two fellowships from the American Gas Association, the Swenson Evaporator Company's fellow-

ship, four fellowships of the Natural Gasoline Association of America, the Thomas Berry Memorial Fellowship for the study of varnishes, and two fellowships from the Michigan Geological Survey. Most of these fellowships pay \$750 a year and tuition. In addition to these there are a number of assistantships paying various smaller amounts, and there is work in the laboratories by the hour on research projects which are financed from the outside. It is not definitely known how many of these fellowships will be available during the school year 1929–1930, but there will probably be at least as many as are available this year.

The preceding discussion of the importance assigned to thesis problems and research work gives a clue to the type of equipment to be found in the laboratories. For the undergraduates, one laboratory course is required, which accompanies the beginning course on the unit operations. There is no equipment provided for this course exclusively, but a wide variety of experiments can be planned by utilizing the special equipment which has been developed for research work. The experiments in this course cover such items as the calibration of an orifice and a flow meter, the testing of reciprocating and centrifugal pumps, heaters, evaporators, filters, stills, crystallizers, and driers.

An important feature of this course is that the apparatus is usually not completely set up for a test, so that the students must do some piping and alterations as they would if they were testing a piece of apparatus in a plant. Part of this general unit-process laboratory is shown in Fig. 1. This shows the centrifugal in the foreground. One end of the Swenson-Walker crystallizer is at the extreme right edge. Still columns, storage tanks, and miscellaneous equipment are in the background. It has never been the policy of the department to collect a museum of miniature chemical equipment by which standardized experiments would be done in a routine manner.

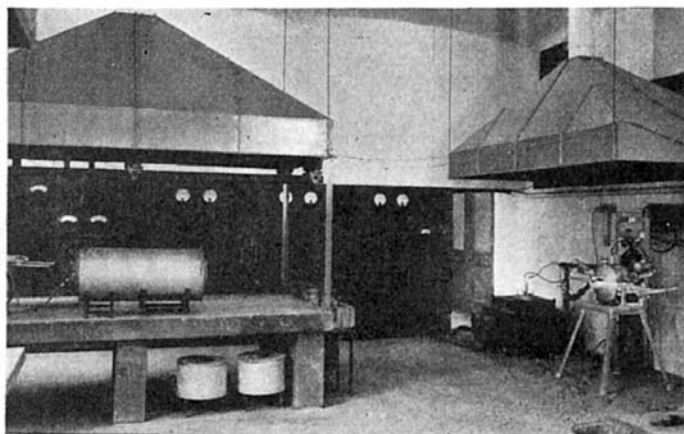

Fig. 3—Electric Furnace Laboratory

Most of the equipment of the laboratory has been installed with the needs of

the undergraduates' thesis work and advanced research students in mind. So far as possible, this equipment has been large enough so that the results may be directly used in the design of actual plants, and at the same time care has been taken to provide flexibility and accessibility to meet the demands of research work. The lines along which the department is specially well equipped follow, in general, the division of chemical engineering into unit operations rather than along the lines of specific industries. The evaporator laboratory is especially well equipped, and is the most complete and extensive in the country.

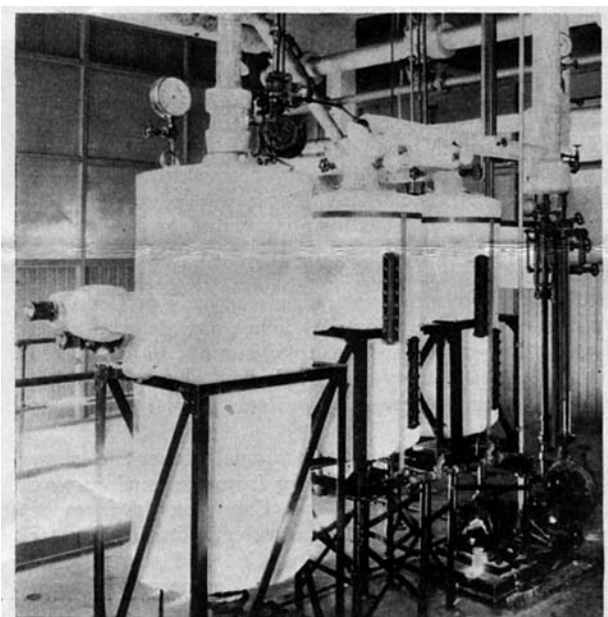

Fig. 4—A Special Set-Up for Fellowship Work
Part of one of the special set-ups for high temperature evaporation. This has been built for the use of one of the holders of fellowships.

Crystallization also represents a research program, and several types of crystallizers are available. There is some equipment for the study of heat transfer, but this is not so elaborate as some of the more specific applications of heat transfer. The laboratory possess several still columns with all the necessary accessories; filter presses, air-conditioning apparatus, experimental driers, centrifuges, tanks equipped for the study of stirring and mixing; and special designed experimental screens. The extent and flexibility of this apparatus is partly illustrated in Fig. 1, but more particularly in Fig. 2. This shows one of the experimental evaporators with a few of its connections. Along the lines of specific industries, there is also some special equipment. At present, electroplating, petroleum refining, and the paint and varnish industries are best represented, although it is planned in the near future to add special equipment for research on pulp and paper manufacture.

An especially complete laboratory is available for the study of motor fuels and their application to various types of automobile engines.

The metallurgical department has special equipment for carrying out all kinds of heat-treating operations in both gas-fired and electrically heated furnaces. There is also special equipment for the study of metals at high temperatures. The university's forge shop and foundry are located in the same building with the Department of Chemical Engineering, and their work is closely coordinated with the work of the metallurgical division. Fig. 3 illustrates one of the metallurgical laboratories containing electric heat-treatment furnaces, and it shows in the background a switchboard for electric-furnace work.

The list mentions typical apparatus which may be looked on as more or less permanent equipment. Much of the research work by both undergraduates and graduates necessitates building special equipment for the individual programs. Space is available for such set-ups, and the department has a well-equipped shop with two mechanics who give their full time to the department. An ample supply of pipe and fittings and other necessary materials are carried on hand in the building at all times. Fig. 4 shows part of one of the special set-ups for high-temperature evaporation. This has been built exclusively for the use of one of the holders of fellowships.

In addition to special apparatus, there are storage tanks, pumps, transfer lines, platform scales, and measuring devices. Most of the apparatus for studying the unit operations is so inter-connected that general processes involving several operations, such as evaporation, filtration and crystallization, can be carried out. As a matter of fact, if desired, the laboratory may be operated as a complete chemical plant using large quantities of material and turning out products in ton lots.

Editor's Note.—The graduate work of the Department of Chemical Engineering is described in a bulletin which has just been published, copies of which may be obtained by writing to the department.



CHEMICAL ENGINEERING AT MICHIGAN

A Critical Analysis of the Curriculum and an Estimate of its Significant Points

by Charles Wadsworth, 3rd, Managing Editor, *Chem. & Met.*†

NOT infrequently the chemical engineering department of a university is somewhat like a poor relation. It receives the hand-me-downs and the cast-offs of other departments as far as equipment and space are concerned. In this respect the department at Michigan enjoys unusual prestige. It was established in 1898 in the College of Engineering under the direction of Prof. E.D. Campbell, whose metallurgical work has won for him national distinction. The growth of the department has been possible because of the active support of Dean Mortimer Cooley of the College of Engineering, who foresaw the possibilities in the field and insisted that it have adequate support. But no one has contributed so significantly to the development of the department and the curriculum as its present head, Prof. Alfred H. White, who has been a member of the department since its founding.



The present building was completed and occupied about a year ago and represents the last work in physical equipment for teaching chemical engineering. The major features are shown in the photographs and need not be further elaborated here.

It is an easy step in logic to conclude that because of the exceptional building and equipment there must be a meritorious staff. No university would invest heavily in a weak department. Under the leadership of Professor White a seasoned, experienced staff has been built up—nearly every member having had industrial experience of some kind. This is important, as it gives the staff an appreciation of the problems that beset the young engineer and in a measure explains the method

† From *Chemical & Metallurgical Engineering*, Vol. 31, No. 26, 999–1,002 (1924).

and theory of the instruction. Perhaps an analogy may help to show what this is. After a child is taught the motions of swimming on the end of a rope, the rope is removed and he must swim alone while the instructor looks on. That is the Michigan system in chemical engineering. Teach the technique for three-and-a-half years and then put the student up against a typical industrial problem. This he must work out under the direction of one of the staff, but with as little help as possible. It helps the student to answer the question, "Can I swim?" It gives him confidence—it is a bit of industrial experience transported inside the college.

The technique of chemical engineering is taught through courses that divide themselves into two groups. The first group—the preparatory group—is common to all engineering work at Michigan; while the second includes the special studies that constitute the professional courses in chemical engineering.

Perhaps the most striking thing about the preparatory group is the emphasis on modern languages. A reading knowledge of one language is required for a bachelor's degree in engineering, and this is usually German for the chemical engineer. To facilitate this, four courses (2 hours per week) are set aside for modern languages in the curriculum. (Throughout this article courses are referred to in terms of credit hours per week for the whole academic year. Therefore, a 3-hour per week course lasting a half year would be called $1\frac{1}{2}$ hours, the requirements for a bachelor's degree at Michigan being 70 hours, according to this system.) If the reading knowledge is gained before these courses are utilized, they may be switched to cultural studies in other fields. This language requirement is inflexible as it is one of Dean Cooley's cardinal principles. The other courses in this group are usual with perhaps two unusual features. The first is the emphasis on English composition, which does not stop with the two required courses but is carried on in the chemical engineering courses with the idea of helping the student to write a clear report of technical problems. The second is the shopwork in metals, which serves as a practical introduction to later courses in materials and metallurgy. It is unique because of the remarkably equipped metal shops with a modern cupola, up-to-date handling equipment, annealing and treating furnaces, and many other pieces of equipment that give the student an insight into metal that would be hard to duplicate.

There is another aspect of this work in metals that deserves attention. It is under the technical control of the metallurgical engineering staff. Practical foremen assist in the work, but the program is laid out and much of the teaching is done by a member of the staff who has no other duties. The student learns the use of pyrometers and of testing machines. If he welds two pieces of metal, he also pulls them apart. If he tempers a drill he also tests the drill in the drill press.

The technical or professional courses fall into three groups—chemistry, engineering, and chemical engineering. Chemistry follows an orthodox line with rather less analytical chemistry than most. This is distinctly desirable and much valu-

able time is saved. There is a great tendency to overestimate the importance of such courses for the engineer, particularly when chemical engineering is under the domination of the chemistry department. There is a decided effort to focus the principles of physical chemistry on engineering problems in the courses given by the chemical engineering staff. This is invaluable to the engineer, as the great weakness in most physical chemistry instruction lies in the neglect of this aspect. It would be better to include both principles and practice in a course given by an engineer.



The main floor of the foundry is on the top floor, which allows a monitor roof and abundant light and air. It also prevents considerable nuisance in the neighborhood, since the fumes are discharged at a high level from the ground. The cupola is shown in the far end of the picture. A traveling crane traverses the whole length of the main bay.

The engineering courses themselves are for the most part orthodox. The course in surveying is unusual and comes surprisingly late in the curriculum for a course of such caliber. Mechanics, machine design, heat engineering, electrical machinery, and strength of materials are all essentials and the time expended seems to be about average. Less time could be spend on some of these subjects if it were practical to give special courses to the chemical engineering student. This it is usually impossible to do.

Under the Department of Chemical Engineering are about twenty-five courses, including six in metallurgy. Of these, six courses, equivalent to 10 hours per week, are required. They include a course on engineering materials, such as metals and alloys, cements, clay products, and protective coatings; a course in fuel utilization and furnace design; a course in metallurgy; two courses in industrial chemistry, and the special problem already referred to. In addition to these courses the chemical engineering students have six hours of electives, and almost invariably they

choose chemical engineering courses. These options include: evaporation; conveying, grinding, sizing; chemical-plant design; heat transfer; drying; distillation and absorption, and others.

There are many points of interest in this group of courses. For example, the two courses in industrial chemistry do not simply enumerate methods of production of industrial materials. The student is required to work out three problems of plant design of increasing difficulty. This of course necessitates the solving of mechanical, chemical, and economic problems to the satisfaction of the class, which reviews each problem. The final problem must be answered in the form of a report to a board of directors, giving the full economic discussion of the recommendation to locate a plant in a given place, and a complete engineering drawing and specification for the equipment.



A detail of the second floor general laboratory showing the crystallizer on the right with a little centrifuge to the left. In the left-hand corner are tanks, and in the rear a water-softening unit of the zeolite type.

It has already been mentioned that the courses in chemical engineering take up fully the physical/chemical background of the specific subject, as for example fuels and furnaces; evaporation, filtration, and distillation; conveying, grinding, sizing, etc. This is important if the amount of curriculum time given to physical chemistry at Michigan is compared with that given elsewhere, for instead of being low it is probably high. It is the right point of view on physical chemistry too—applied! Many educators, particularly chemists, are inclined to forget that for industry, physical chemistry minus application is like a case of tools with a padlock on it. Chemical engineering is more nearly applied physical chemistry than any other single thing, hence the attention to applied physical chemistry is of prime

importance.

The courses in more detail can be seen and studied in Table 4. The last column gives the total number of hours per week for a full year (70 of these credit hours being required for the bachelor's degree). No attempt has been made to evaluate separately the clock and credit hours, for practice is fairly uniform throughout the country both as regards the ratio of laboratory to credit hours and the distribution of laboratory work uniformly throughout the courses. It is also worth noting that the required chemical engineering plus the elective courses that are usually chemical engineering total $15\frac{1}{2}$ hours.

Table 4 *Subjects Required for the Bachelor's Degree*

<i>Subject</i>	<i>First Year</i>	<i>Second Year</i>	<i>Third Year</i>	<i>Fourth Year</i>	<i>Hours</i>
English	English Comp.			Engin. Engl.	3
Mod. Lang.	<i>See explanation</i>	<i>See explanation</i>	<i>See explanation</i>		8
Economics			Princ. Econ.		$1\frac{1}{2}$
Physics		General Phys.			5
Math.	Algebra, Anal. Geometry	Calculus			8
Chemistry	General	Qualitative Quantitative	Organic Theoretical		10 4
Engineering	Metal Shop Drawing & Descrip. Geom.		Mechanics Heat Engines Adv. Drawing	Electr. Machin. Machine Design Strength Matls. Surveying	5 $3\frac{1}{2}$ $5\frac{1}{2}$ 1
Chemical Engineering		Engr. Matls.	Fuels/Furnaces	Metallurgy Inorg. Industrial Org. Industrial Special Probs.	$4\frac{1}{2}$ 1 2 $2\frac{1}{2}$
Miscel- laneous			<i>Approved electives</i>	<i>Approved electives</i>	$5\frac{1}{2}$
<i>Total hours</i>	$16\frac{1}{2}$	$17\frac{1}{2}$	18	18	70

There are two points of general significance in the Michigan curriculum. The first is its flexibility. Every course in chemical engineering is repeated in each semester. This permits both a convenient program for the student and smaller classes with closer individual attention. The second point is the course, already referred to, called *special problems*. "To train the student in methods of independent study"—after all, that is the most important thing a curriculum can do. All the technical courses in the world amount to nothing if they cannot be used as tools for original work. Every industrial problem is either entirely or in large measure original work and the student who cannot work without direction is like a rudderless ship. This, then, is the aim at Michigan; to fit the student to carry

out an industrial problem on his own initiative before he graduates.

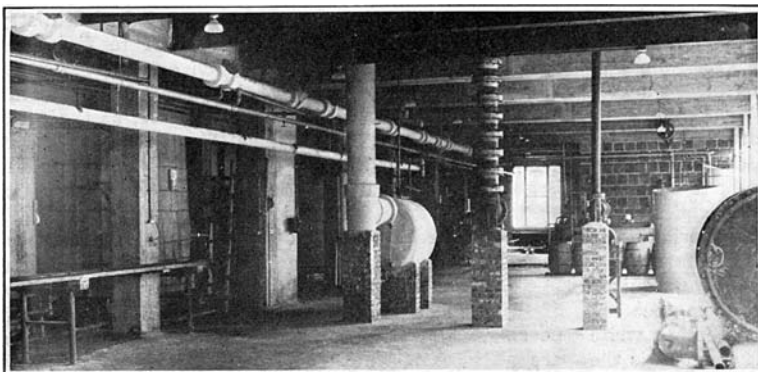

The general laboratory on the second floor, showing stills for fractional distillation. They are heated internally by electric coils for convenience in measuring the input of energy and also to avoid fire hazard.

Graduate work is being stressed and the number of students admitted as candidates for the doctor's degree is increasing. This means that time, attention, and encouragement are given to research activity. There are many concomitant advantages. It brings the undergraduates into social touch with men more advanced and more mature. It broadens the horizon immeasurably and the out-of-course activities have profound influence on the student's development.

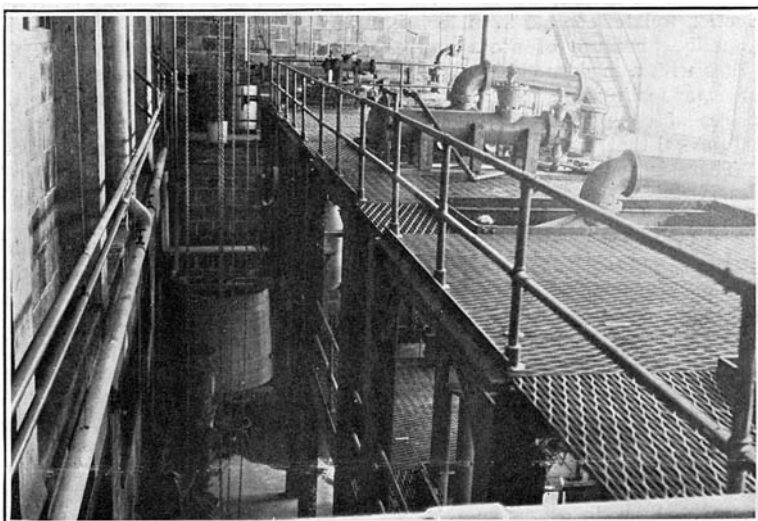

The evaporator laboratory with the filter press floor visible in the background. The wide well facilitates erection work. Two of the three evaporators can be seen.

Along this line there is another point that is most important. Michigan is a large university and men are being trained in almost every profession. The prospective engineer sits next to the architect at table and the art students are his fraternity brothers. This means inevitably that the individual student comes into contact with many points of view and with much that goes on in other lines of effort. Vicariously the student becomes familiar with the great names in other fields and with the methods of thought and action of men in other professions. It is one of the advantages of a university course in chemical engineering.

WALTER J. PODBIELNIAK

WALTER J. Podbielniak (B.S.E. 1925, Ph.D. 1928) was one of our early students whose graduate work led directly to an outstanding career after he formed his own company. He wrote his doctoral dissertation, *Vaporization of Complex Mixtures*, under the supervision of G.G. Brown.



Tony Francis

Walter J. Podbielniak.

To recognize his lifetime of technical achievement, Walter Podbielniak received a University of Michigan Outstanding Achievement Award on 19 November 1977. The award is reserved for “alumni who have attained distinction and have demonstrated outstanding accomplishment in their work.” There were just three other recipients in all fields during 1977, and the award was presented by President

Robben Fleming at the U–M Glee Club concert in Hill Auditorium. Dr. Podbielniak was accompanied by his wife Nancy, and since the Ohio State/U–M game “happened” to be on the same day, they were the guests of the U–M for that event, too. (The score was Michigan 14, Ohio State 6.)

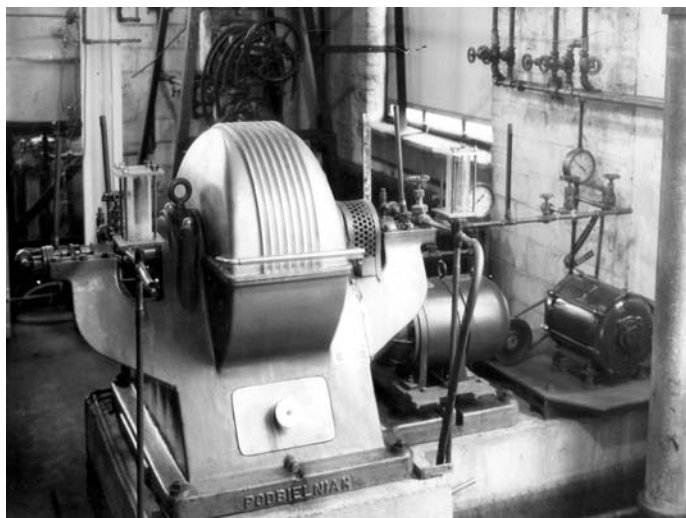

Podbielniak centrifugal solvent extractor.



Nameplate for the Podbielniak centrifugal extractor donated to the department.

Dr. Podbielniak’s award was based on three distinct and important contributions to chemical engineering, which were recognized in his citation:

- First, he developed and perfected the low-temperature fractionation column, which for many years was the only practical method for analyzing samples of

natural gas and gasoline. It has been hailed as “one of the truly great contributions of all time in the field of natural gas and petroleum science.”

- Second, he invented and marketed the ingenious centrifugal contactor, used extensively for the past 30 years in a wide variety of solvent-extraction operations, including the refining of oils, the extraction of uranium, and the recovery of penicillin and other antibiotics from fermentation broths. The contactor has been viewed as “probably doing more than anything else to advance the cause of the antibiotic industry in its early days.”

- Third, an early (1936) patent, on the use of mixed refrigerants for the liquefaction of multicomponent gases, anticipated by 30 years the refrigeration systems used in the large LNG plants of today. Dr. Podbielniak is “recognized for having been a real innovator in the field of mixed refrigerant systems.”



Some of the guests at the dedication of the Podbielniak Reading Lounge: George Carignan, Elisabeth Swift, Brymer Williams, Nancy Podbielniak, Jim Wilkes, Mary Ann Wilkes, Ralph Yang. Sept. 1997.

Dr. Podbielniak also took advantage of his trip to Ann Arbor to make a gift to the department. In conjunction with Baker-Perkins, Inc. (of Saginaw, Michigan, and manufacturers of his contactor), he presented the department with a Model A-1 centrifugal contactor. The unit has a capacity of 2 liters/minute; with a maximum operating speed of 10,000 rpm, the maximum centrifugal force, at the rim, is equivalent to about 10,000 times that of gravity. The contactor has been installed in our Unit Operations Laboratory.

Walter Podbielniak died in 1978.

Reception Honoring Mrs. Nancy Podbielniak

The furnishing of the Podbielniak Reading Lounge in our department after its move to the North Campus in 1982 was made possible by a very generous donation from Walter Podbielniak and his wife Nancy, who still lives in Rancho Santa Fe, California. A reception was held in Nancy's honor when she visited the University of Michigan on Thursday, 11 September 1997, accompanied by her sister, Mrs. Elisabeth Swift. The occasion was to celebrate the refurnishing of the Walter J. Podbielniak Reading Lounge, which is heavily used for departmental receptions and other meetings. The room was refurnished by University of Michigan interior designer Marcia Reed working in collaboration with faculty member Jim Wilkes. The color scheme is generally warm cherry. The refurnishing includes new carpet and improved lighting, a long cherry wood conference table and alcove serving counter, and 24 chairs with attractive multicolor stripe seats.

The room is highlighted by two striking works of art. The first of these, which has been with us since 1985, is Frank Stella's *Sinjerli Variations Squared with Colored Grounds*, a lithograph/screen-print based on a circular configuration from Stella's "Protractor" paintings of 1967–1970 (see page 298). The second is a very large collage, *A True Story*, commissioned by Nancy Podbielniak and executed by Elenore Hughes of La Jolla, California.



"A True Story," a watercolor collage by Elenore Tolegian Hughes, in the Podbielniak Reading Lounge. Commissioned in 1997 by Mrs. Nancy Podbielniak, the art depicts the life and accomplishments of Dr. Podbielniak.

A True Story depicts some of the significant contributions made by Dr. Podbielniak through his work in chemical engineering, especially to petroleum science

and antibiotic production. The work is informed by the collaboration of Mrs. Nancy Podbielniak for personal reflections of her late husband's accomplishments and personality, and Jim Wilkes for scientific perspective. It includes a greatly enlarged microscope picture of a penicillin cell, borders of penicillin molecules and low-temperature fractionating columns, parts of Dr. Podbielniak's many patents, and music of Chopin that he loved to play; the whole is pervaded by a "Lifesaver" motif.

The reception was attended by chemical engineering faculty, staff, and friends. Brief speeches of welcome and thanks for the work and generosity of Walter and Nancy were made by George Carignan (associate dean of the college), and faculty members Brymer Williams and Jim Wilkes; Nancy responded with obvious enthusiasm for the elegant refurbishing of the room in her husband's memory.

A FEW RECOLLECTIONS from Cedomir M. Sliepcevich

HERE are some more thoughts for your historical account, bearing in mind I can speak only of impressions I had prior to my departure in 1955:

1. Michigan was unique in Chem and Met, which made it different from other schools. The faculty were "robust." Although they stressed the fundamentals, they also crossed the bridge to practice for the student's benefit. The faculty were heavily involved in practical-type consulting work. Industry employed them as problem solvers rather than using them primarily for continuing education of their employees. (Nowadays most consultants are employed as either "short-course instructors or ambulance chasers.")

2. Much of their consulting work involved—in the course of problem solving—generating new data in the laboratory on which students were employed. Some of the consulting work involved even new process or product development.

- (a) Badger's work for Swenson on multi-effect evaporation and for Dow Chemical on Dowtherm are examples. Subsequently, Dow's R&D division actually evolved as an outgrowth of Badger and Baker's problem solving and new product development for them. I recall Baker's long-time graduate assistant (not Hendricks, but the handsome blond guy) working in the east end of the Unit Ops Lab second floor, to find solvents for carbon. I didn't think at that time that it was possible. Dow was initially interested in dissolving carbon (or soot) from internal combustion engines but later applied it to household ovens ("Easy Off" and the like). About this time Brier developed the process for extracting celery-seed oil for some company, and, once he did, he continued to supply the world's demand from his "pilot plant" in the basement of the Unit Ops lab for many years! I recall (shades of "Sound of Music") the corridors of East Engineering reeked with the smell of Dowtherm and celery-seed oil. In

fact, the last time I was in the East Engineering building in 1989, I could still smell it. Also don't forget Podbielniak's fractionating column.

- (b) Over in the metallurgy side, Freeman with C.L. Clark of Timken, (a Michigan grad I believe) and C.T. Evans of Universal-Cyclops were largely responsible for making their companies major world players in developing creep-resistant alloys for aircraft turbines. C. Seibert and E. Baker played a major role in bringing Haudaille-Hershey Inc. and Muskegon Motor Specialties to the forefront as specialty metals suppliers. And didn't Cottrell develop his electrostatic precipitator in Ann Arbor?

3. Although Bob White is generally (and rightfully) credited with introducing the rate-concept approach into the unit operations sequence (about 10 years before Bird's book surfaced), he was not the first one to use it at Michigan. Don McCready taught Unit Ops 9B only once, in the spring of 1941, when I took it. Foust had started teaching it, but I think he was called up as a reserve officer about that time. McCready started out with Ohm's law as an example of "driving force divided by resistance" equals "quantity transferred." He then introduced a coefficient, K , to account for departure from Ohm's law due to non-linearities. He repeatedly referred to this transfer coefficient as the factor to take care of "all our sins, errors and omissions." He then introduced the time derivative and proceeded to derive simple equations for steady and non-steady states. As a result, I couldn't understand what all the "hubbub" was about when the rate concept surfaced.

At his request, I had been reviewing Bob White's notes that he was developing on "rate processes" while he was on sabbatical or special leave. During discussions with him one day, he said he was uncomfortable with the terminology "rate processes" because the word "processes" had acquired a "dirty" connotation of something purely descriptive. On the spur of the moment, I suggested "rate operations" and he agreed. Thereafter, at least by the time Stu Churchill took over responsibility for the graduate course in heat transfer and fluid flow, it became officially known as *Engineering Rate Operations*. When I went to Oklahoma in 1955, I did likewise since I had been sharing the load with Stu in CM 213. Subsequently, at Oklahoma, Jack Powers, Orin Crosser, Eric Weger, Bob Perry, and Bill Orthwein pushed ahead, and when Bird asked us to comment on his class notes, we went one step farther and used them as a textbook until his book was published. Since Stu credits Bob White with inventing the rate-operation concept, I go along, because Stu knew—better than anyone I ever knew—of what he spoke in this area.

4. Michigan was really at the forefront on big-time developments, during the forties, so both faculty and students were able to rub shoulders with some of the great scientists of the day. I actually had the opportunity to work with many of the giants of the day, particularly Nobel prize winners Debye, Bridgman, and Chandrasekhar, not to mention a host of German rocket scientists. Pretty heady!

MID-CENTURY PIONEERS: BROWN AND KATZ

AN APPRECIATION OF GEORGE GRANGER BROWN

September 3, 1896–August 26, 1957†

GEORGE Granger Brown was born in New York City on September 3, 1896. His parents, George Giffins and Emma Lee Tuttle Brown, were of early American ancestry; his father was a commission merchant. After graduating from Erasmus Hall High School of Brooklyn in 1914, he attended New York University. Upon receiving a bachelor's degree in chemical engineering in 1917, he entered the employ of the Aluminum Company of America at Massena, New York. In 1918, he served in the Chemical Warfare Service at the American University of Washington, D.C. While serving as a production manager of the Union Special Machine Company of Chicago in 1920, the late Alfred H. White induced the young man of 24 years to come to the University of Michigan as instructor in chemical engineering.

His career of 37 years at the university began by carrying on three activities, graduate study, teaching, and research, simultaneously—an indication of his vigor and zeal. As a graduate student, he explored thermodynamics from the physicists' point of view and was introduced to the processes of the petroleum industry by Professor E.H. Leslie. His doctorate thesis, completed in 1924, was entitled *The Rate of Pressure Rise in Gaseous Explosions*. As an instructor, he developed material for the fuels and combustion course. He organized graduate courses in thermodynamics and in petroleum refining. For a research project, he compiled data on clays and shales of Michigan under the auspices of the State Geological Survey. Upon completing the doctorate, he progressed through the academic ranks, receiving appointments of assistant professor in 1925, associate professor in 1927, and professor in 1930 at the age of 34.

In 1925, Professor Brown embarked on a major research program for the Natural Gasoline Association of America of Tulsa, Oklahoma. As director of research for that organization, he guided graduate students into doctorate problems on vapor pressure and vaporization of the volatile hydrocarbons. His work with automotive engines showed the influence of fuel volatility on the performance of motor fuels, especially their ability to start cars on a cold winter morning. This research

† Written by Donald L. Katz on 21 October 1957.

along with additional activities in combustion brought him acclaim as a leading expert on automotive carburetion and motor performance.



George Granger Brown.

The blending of thermodynamics with the background gained from contact with the petroleum industry became the basis for a second major program of research. More than twenty doctorate theses under Professor Brown's supervision developed into the thermodynamic properties of hydrocarbons, vapor-liquid equilibria, and the application of this information to such processing operations as distillation, absorption, and extraction. His professional activities were directed toward the improvement of designs for petroleum-cracking plants and his services were in demand for patent litigation. Efforts towards a textbook on petroleum resulted in the first section of *Natural Gasoline and the Volatile Hydrocarbons* and a series of about one hundred charts presenting physical and thermodynamic properties of the hydrocarbons. Before his work was completed, he turned his attention to administrative affairs.

Professor Brown succeeded the late Alfred H. White as chairman of the Department of Chemical and Metallurgical Engineering in February of 1942. He directed his efforts immediately toward revising the curriculum, introducing undergraduate courses in thermodynamics, solid-state science, and process design. He led a group of twelve staff members in writing a textbook, *Unit Operations*, which was adopted by over 50 colleges and universities when it appeared in 1950.

Dr. Brown's professional colleagues recognized his contribution to engineering through the William H. Walker Award of the American Institute of Chemical Engineers in 1939 and the Hanlon Award of the Natural Gasoline Association of America in 1940. The U-M recognized his scholarship by appointing him the Edward DeMille Campbell University Professor of Chemical Engineering in 1947 and by selecting him to give the Henry Russell Lecture in 1955.

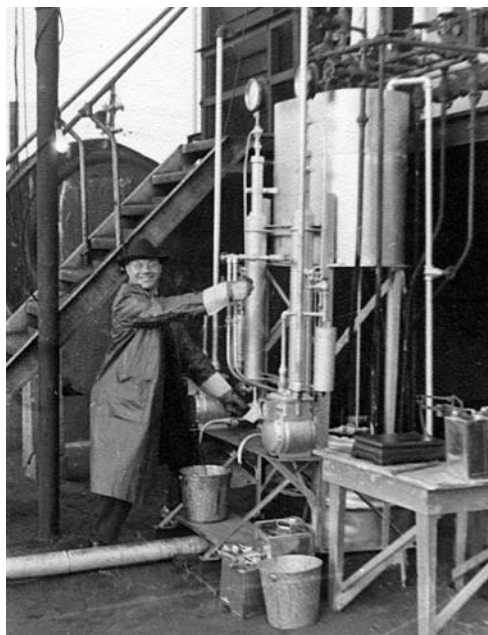

Courtesy Judson G. Brown

G.G. Brown demonstrates a "hands-on" approach to unit operations.

Paralleling Dr. Brown's service to the university were his activities in professional societies, especially the AIChE. He served with distinction on several committees of the institute, was elected director in 1940, vice-president in 1943 and president in 1944. His chairmanship of the Education and Accrediting Committee of the institute and his service to the Engineers Council for Professional Development provided leadership in improving our educational standards in the post-war period. In 1953, he returned to active participation in AIChE affairs by accepting the position of treasurer and member of the Executive Committee. Memberships in professional and honorary societies included the American Chemical Society, American Society for Testing Materials, Society of Automotive Engineers, American Society of Engineering Education, Phi Beta Kappa, Sigma Xi, Tau Beta Pi, and Phi Lambda Upsilon.

Dr. Brown's services as consulting engineer were in great demand. In addition to serving as an expert witness and consultant on design in a variety of cases, he

organized and established the research laboratories for the National Dairy Products Company, Inc. He and Mrs. Brown lived at the site on the Vanderbilt estate on Long Island while on leave from the university during the 1947–1948 school year. He served as director of engineering for the Reactor Division of the Atomic Energy Commission from 1949 to 1951. In the business world, he held positions of responsibility such as vice-president and director of the Dixie Refining Company, president of Hillcrest and Washtenong Memorial Associations, director of American Motors and director of the Internuclear Company.



Courtesy Judson G. Brown

G.G. Brown.

In 1951, Professor Brown was selected to succeed Dean Ivan C. Crawford as the sixth dean of the College of Engineering. Dean Brown's accomplishments are well known by the faculty of the college. They include the development of plans for engineering laboratories on the North Campus and developing the interest of the industrial organizations in the activities of the university. His efforts to revitalize and integrate engineering education are exemplified by the introduction of the science engineering program and the promotion of graduate programs in nuclear engineering and instrumentation engineering. His fervor for progress in engineering education and for work of high quality caused even those who did not share his views in some areas to accept his leadership of the college to its high position among the engineering schools of the nation.

The intellectual excitement that Professor Brown brought to the classroom and the laboratory gave him a reputation that attracted students to the university from all parts of the world. The students found a new meaning to logic and processes of reasoning as methods of solving engineering problems. Dr. Brown raised the curtain to a broader intellectual horizon and inspired many to explore new fields of research. The young instructor felt Professor Brown's support, friendliness, and

encouragement as he embarked on the teaching of a new course or into a new field of investigation. Dr. Brown's willingness to consider new and better ways of doing things made him a friend of progress. He provided an excellent testing ground for new ideas by virtue of his quickness to grasp them and his love of discussion and debate. The example of his devotion to engineering education and intellectual attainment will continue to be an inspiration to his many students and colleagues at the university and throughout the world.

His colleagues in the College of Engineering share with Mrs. Brown and their three sons and families the sorrow which Dean Brown's death has brought to his many friends.

RECOLLECTIONS OF G.G. BROWN†

by Cedomir M. Sliepceвич

DURING my junior and senior years at Michigan (1939–1941) I had only a casual acquaintance with G.G. Brown, but this relationship changed indelibly as soon as I enrolled for graduate work in the fall of 1941. My first encounter¹ (an understatement, to be sure) with him was in his renowned course in thermodynamics (then known as Chem & Met 105), which was required of all chemical and metallurgical students pursuing a master's degree. In those days chemical engineering did not offer an undergraduate course in thermodynamics. However, undergraduates did get a substantial exposure to the subject matter of thermodynamics in four courses: two in chemical engineering (industrial stoichiometry and inorganic chemical technology), one in chemistry (first semester of physical chemistry), and one in mechanical engineering (heat engines).

It is my understanding that Brown first introduced the graduate course in thermodynamics in the mid-1920s, possibly as early as 1925. A year earlier, Brown requested the famous physicist, Dr. George Uhlenbeck, to teach a special course in classical thermodynamics for graduate students in chemical engineering.² One thing for certain, once chemical engineering thermodynamics was introduced into the curriculum, Brown retained a monopoly on teaching it with one exception. On occasions when student enrollment warranted it, Professor C.A. Siebert taught a substitute course exclusively for majors in metallurgical engineering.

† Prepared by C.M. Sliepceвич in September 1997 at the request of G. Brymer Williams for this historical publication commemorating the 100th anniversary of chemical engineering at the University of Michigan.

¹ Aside from his high decibel level of vocalizing, G.G. Brown was an imposing physique: standing close to two meters in height and weighing in at around 100 kilos. His close acquaintances called him "G.G."; both his intimidated admirers and his fainthearted critics referred to him as "Great God" with no disrespect intended. Whatever the category of acquaintanceship, however, there was general agreement that G.G. was a redoubtable logician. For me, I played it safe: I always addressed him as Professor Brown.

During the 1930s, Brown was one of the four B's (W.L. Badger, E.M. Baker, J.C. Brier, and G.G. Brown) who brought much well-deserved notoriety to the Chemical Engineering Department. Brown, Badger, and Brier were dynamic individuals, whereas Baker was a more modest—though equally capable—individual. It is significant that of these four stalwarts only Brown had a doctoral degree.

² Communication from G.B. Williams.

In teaching thermodynamics Brown never used a textbook; in fact he was inclined to be critical of most of them. His principal objections to the books were:

1. Preoccupation with developing equations—on the average over 1,500 equations per text—most of which were of no practical value except for the sensual exhilaration that some might experience in deriving them.
2. Cookbook style of problem solving.
3. Preoccupation with ideal gases, ideal solutions, and reversible processes.³
4. Emphasis on memory alone without understanding or thought; logic or philosophy were rare commodities.

Of all the textbooks available in 1941, Brown had the most praise for Joseph H. Keenan's *Thermodynamics*, published in 1941, and Mark W. Zemansky's *Heat and Thermodynamics*, published in 1937. He did not discourage students from reading textbooks, but by the same token he didn't push it. He did, however, pass out his classic paper, "Introduction to Chemical Engineering Thermodynamics," *Transactions of the American Institute of Chemical Engineers*, **34** (5) pp. 489–527 (1938), which he had presented at the White Sulphur Springs, W.Va. meeting, May 9–11 (1938). He covered the first and second laws, the potential concept of availability, and criteria for equilibria in very compact form: *a paragon of brevity to say the least*.



Cedomir Sliepcevich

Brown's style of teaching was unique. For the first dozen or so class meetings he "prohibited" the students from taking notes because he wanted them to concentrate on thinking rather than writing. His early focus was on the definition of heat and work and the basic distinctions between them. He emphasized the need for a precise definition of a system and its boundaries, paying special attention to "frictional" processes that can take place at the interface between the system and the surroundings, which obscure the clear identification of heat versus work. He brought forth numerous examples which at first appeared trivial but later appeared hopelessly unsolvable. He was fanatical about algebraic signs. Time and again he emphasized that the correct sign on an incorrect numerical result was only

³ I recall Brown reading from a widely used text book (a "bible" so to speak) that the effect of pressure on enthalpy was usually negligible. According to him, the designers of a major refinery in the Chicago area had taken this statement at face value. The result was a refinery that was inoperable because the heat balances were wrong. Brown was called in as a consultant to trouble-shoot and very quickly discovered the problem. To rectify it cost the company millions of dollars, which in those days was a tidy sum. Much of Brown's consulting work involved the practical application of thermodynamics; his reputation was legendary and much-deserved.

100 per cent wrong, but an incorrect sign on even a correct numerical result was 200 per cent wrong. His classes were neither formal lectures nor pedantic recitations. They were, simply put, class discussions with a premium on argument. In fact, Brown encouraged the students to get together in small groups of two or three outside the classroom solely for the purpose of arguing and coming to grips with the esoterics of thermodynamics.



A.B. Newman

A.H. White and G.G. Brown, on a trip to Charleston, West Virginia, at the time of the May 1938 AIChE meeting. The photograph was taken by Albert Broadus Newman, a U-M Ph.D., then chairman at Cooper Union, and a close friend of G.G. Brown.

Another one of Brown's pedagogical techniques was to single out early, one thick-skinned student in the class who would—for the rest of the semester—become the butt of his vocal barbs on days when the rest of the class appeared passive or indifferent to his efforts to drive them into confrontation. This tactic was well known in advance by the students who tried to create as small a profile in the class while hoping and praying that they would not be “so honored with this dubious distinction.” Anyway they could slice it, the students viewed the hapless selectee as the “goat” of the class, but at the same time derived pleasure from the barbed exchanges between teacher and victim.⁴ In this day and age, it might be

⁴ Charles Heinen was one of my classmates. Upon graduation he went to work for Chrysler, where he enjoyed a highly successful career. Upon the occasion of his retirement, and in the course of an interview, he was asked to identify some of his most memorable classes and classroom experiences. His response was Chem & Met 105, not only because he learned the most there but also because he always looked forward to Brown

difficult to comprehend or endorse such antics in the classroom. By and large the engineering professors at Michigan were inclined to be tough on students; spoon-feeding students was not in their repertoire.

It so happened that when I took thermodynamics, I was the target. Although invariably I came out on the short-end of an argument—even looking like a clod more often than not—I learned a lot more about thermodynamics than I would have otherwise.⁵

Late in the fall of 1941, Brown was named chairman of the Department of Chemical and Metallurgical Engineering, to succeed Professor A.H. White. Rumor had it that White had stepped down voluntarily and offered the chairmanship to Brown in the hope of keeping Brown from accepting the chairmanship of chemical engineering at the newly formed Northwestern Technological Institute. Brown's acceptance of the chairmanship presaged the beginning of the end of a unique teacher and researcher and the rise of a dynamic academic administrator. At that point in time Brown had supervised more doctoral theses than anyone else in all of engineering. Although a majority of his doctoral students had in recent times been working on measuring the thermodynamics properties of hydrocarbon mixtures, his research also included significant contributions to catalytic cracking (both chemical kinetics and heat transfer), absorption, fractionation, extraction, evaporation, multi-phase flow, octane enhancement of gasoline, and stabilization of lubricating oil. A characteristic of his research was that, aside from the equipment used to measure thermodynamic properties, pilot-plant-size equipment was used for his studies on unit operations and chemical processing. His philosophy here was that any data generated should be immediately useful in the design of full-scale process plants.

Although I had originally intended to leave the university after my master's degree in June 1942 and to take a job in industry, I really wasn't anxious to leave Ann Arbor. Because of the war, graduate-student enrollment had dwindled down to a dozen or so students; nevertheless, chemical engineering was bound and determined to keep the program afloat. Brown was winding up a classified project for the navy on the mechanical formation of screening smokes and he offered me a full-time job for the summer of 1942 to assist Dr. Fred Kurata in completing the experimental work, correlating the data and writing the final report. Simultaneously, I was given an appointment as a teaching assistant in the Unit Operations Laboratory for the summer. In addition, I was working with Professors D.L. Katz and G.G. Brown on a consulting project related to retrograde condensation. For the period June 1942 to June 1944 I was employed on several classified projects, sponsored research, and private consulting work, all related to the war effort. During this period I also served as a teaching fellow in the Physical Measurements

and Sliepcevich "going at it."

⁵ I am reminded of an old, "off-color" joke that really mimics the situation here. Rather than run the risk of antagonizing prurient sensibilities, I'll settle for "Nothing ventured, nothing gained."

Laboratory.⁶

In June 1944, I was back in the thermodynamics pipeline after an absence of about two years. When Brown became chairman in the fall of 1942, he moved as rapidly as possible to make major changes in the chemical engineering curriculum. In the summer of 1944, an undergraduate course in thermodynamics (CM 111) was initiated, consisting of two hours of lecture and one hour of recitation per week. The lecture section ran about 100 students, and the recitations were divided into five sections of about 20 students. Brown and Katz were responsible for handling the lecture section; I was assigned to teach all five sections of recitation and to grade all home problems and quizzes as a teaching assistant. (I still cringe when I recall grading on the average of 300 to 400 problems per week.) Keenan's thermodynamics book was designated as the primary reference for reading, but all of the problems and quizzes were "homemade" by Brown, Katz, and me. I continued to serve as a teaching assistant in both the undergraduate and graduate courses in thermodynamics (in addition to work on consulting projects and sponsored research from time to time) until the summer of 1946. When I received my appointment notice for the summer of 1946 I noted that my title had

⁶ During the spring of 1943, D.L. Katz was a consultant for the Kellex Corporation (the defense-related arm of the W.W. Kellogg Construction Company). One of the problems was to design finned-tube heat exchangers (somewhat a novelty in those days) for the thermal-diffusion separation section of the Oak Ridge Atomic Energy plant then under construction. Since essential heat transfer and pressure drop data at high throughput rates were not available, Katz was asked to undertake this assignment. Since he already had other commitments that required him to be away from Ann Arbor, he asked me to undertake the project of designing, building, and operating a fairly large experimental facility for this purpose. Frankly, I was more excited about working on a top-secret project than I was with the successful outcome that we experienced. The ink had not even dried on the final report for Kellex when I received a call from a company in Chicago that was involved in the development of the proximity fuse. (I had previously done some minor consulting work for them.) My assignment was to go to the Johns Hopkins Applied Physics Laboratory in Silver Springs, MD, to evaluate their program for developing power sources for the proximity fuse system. While I was in the process of completing my final report with recommendations, I received a surprise phone call at the Shoreham Hotel from G.G. Brown. When I picked up the phone the first words I could hear was his gruff voice: "Are you through being a big shot?" (It was the first time that I sensed he was not too happy about my leaving Ann Arbor for an extended period without his knowledge even though I was not on the university payroll at the time.) When I asked him what he had in mind he responded that he needed me to go to Houston, Texas to be the resident-engineer on the construction of a full-scale, high-pressure gas-condensate sampling plant at the Katy Recycle Field. I had never been to Texas, and although I had done many tedious flash calculations for Brown and Katz on condensate wells, I had never even been near a gas well. Without hesitation, I told him I would be back in Ann Arbor within a few days, specifically the following Friday evening. His response was: "Good! See you in my office on Saturday morning." When I arrived, he advised me that we didn't have much time because he himself was leaving town that afternoon on another job. He explained briefly what the Katy project was all about; he handed me a *free-hand* process piping diagram and an airlines ticket departing for Houston the very next day, Sunday, because the Brown and Root Construction Company was scheduled to initiate work on the following day, Monday. He then shook my hand, wished me luck, and assured me that he would get to Katy as soon as he could. To those who didn't know Brown, there might be the temptation to accuse him of being somewhat irresponsible. On the other hand, Brown seemed to be unusually clairvoyant about the capabilities of individuals who worked closely with him—more so than the individuals themselves did. On top of that Brown had the dominating personality which seemed to beam: "Don't you dare screw up because I won't tolerate it." For the record, both Brown and Katz eventually rearranged their busy schedules so that they could spend a substantial amount of time with me and my associate, Mike Rzasa (one of Katz's doctoral students), in Houston to guide the project to a successful completion.

Brown's philosophy on graduate work was to give the student maximum exposure to practical engineering as feasible. Also, since fellowships were few and far between, most graduate students assisted the faculty, usually by grading papers, and to a lesser extent, teaching laboratory or recitation sections. Brown was *adamant* on one point, however. He would not allow a student to be paid for any work that was applicable to his thesis except for unrestricted fellowships or scholarships.

been upped from teaching fellow to instructor with a corresponding, though very modest, increase in salary. I suspected something was brewing.



Courtesy Judson G. Brown

G.G. Brown in the classroom, 3215 East Engineering, ca. 1937.

As I walked into the first lecture class in the undergraduate course, CM 111 (I always tried to attend the lecture sessions when I was assisting), Brown motioned for me to join him in front of the room so that he could introduce me, I assumed, as the assistant (which was SOP with him). He began by telling the students that due to a heavy schedule of commitments, including frequent travel, it would not be fair to the students if he attempted to teach the class. Therefore, he had decided that I should be the sole instructor in the course. He assured the class that I would do a better job of teaching the course than he could under the circumstances and that I was fully qualified. With that, he wished me luck and then he walked out of the class.⁷ It was then that I felt he had passed the first of his two batons in thermodynamics—the *undergraduate* one—to me. In that brief moment, I experienced mixed emotions. It was evident that it was the beginning of the end for the master communicator of thermodynamics; it was only a question of time—and not much at that—before the pressure of administrative duties and other obligations would force him to pass his *graduate* thermodynamics baton. Al-

⁷ Although Brown did not visit this class again, he requested that I prepare a detailed summary of lectures and copies of all problems and quizzes along with the solutions. Each week the departmental secretary would type the lecture notes, assemble the problems and quizzes, and leave it on Brown's desk for review. Somehow he managed to find time to stay current by reading the material; in this way he was able to monitor my work closely.

though I was truly saddened to see Brown leave class that day, I was excited about teaching my first lecture course—all by myself and particularly in thermodynamics. I suspect that ever since 1925, thermodynamics had been hallowed ground in chemical engineering on which no one dared to tread except G.G. Brown.

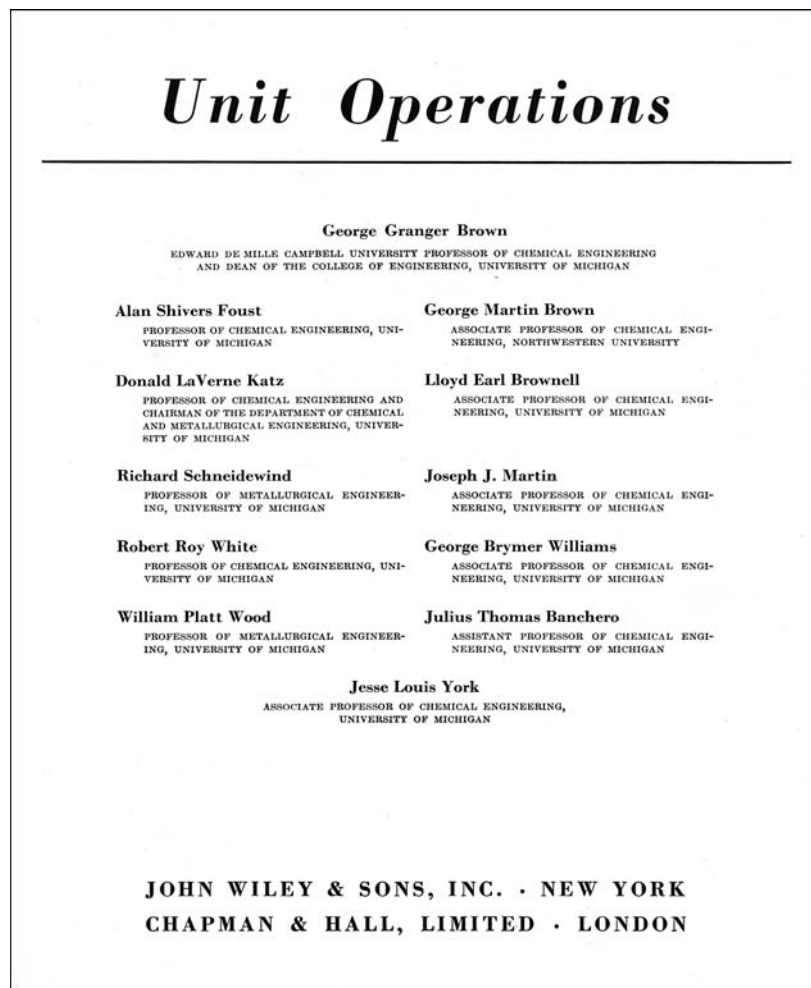

Title page of "Unit Operations."

Brown continued to teach graduate thermodynamics for the fall semester of 1946. Although I continued to be responsible for the undergraduate course, I assisted him in the graduate course for that semester. Just as I predicted—except sooner than I expected—he “dropped the other shoe.” Following this semester, in the spring of 1947, he officially passed the second (graduate) baton to me (half a century ago as of this writing.) To my recollection he did not teach again.

Undoubtedly the most demands on his time at this juncture were related to

his duties as departmental chairman. A very close second was his drive to finish a new text book, *Unit Operations*, which he had undertaken to write with eleven other collaborators on the staff. Many were the times that I found him working in the wee hours of the night and on weekends, composing, revising, and editing by long-hand. Brown was determined to be the first to bring a new book on unit operations to the market. He felt that the continued prestige of the department depended greatly on it.

When Brown decided to leave the classroom, he also began to phase out his doctoral research program. By 1951, when he was appointed dean of the College of Engineering, he was dedicated to devote full time to academic administration. His high priority projects included revamping the curricula in all of the engineering programs, bringing the far-reaching, multi-million dollar, defense-related, sponsored research, known as “Project Michigan,” back into the academic fold, and expediting the development of the North Campus as the new home for the entire engineering school.⁸



Courtesy Judson G. Brown

A moment for reflection—G.G. Brown, late 1930s.

Every so often, after Brown had forsaken the classroom and had become pre-occupied with being a department chairman, first, and engineering dean, subsequently, he would walk into my office unannounced, close the door, sit down and

⁸ Brown included me on an ad hoc committee of four to review the entire engineering curricula, to make recommendations for changes that needed to be made along with timetables for accomplishing them. He also made me a committee of one to spend whatever time I needed to become familiar with the research and development work at the Project Michigan Willow Run Research Facility in order to encapsulate the technical program for him so that he could obtain a more detailed familiarity with it in the shortest time possible. Brown was determined to move quickly since the university still had fiscal responsibility for this program, and he was determined that it should not continue to operate autonomously without any academic oversight.

say: “I need to recharge my batteries; let’s argue thermodynamics. These administrative headaches are driving me up the wall.” We would go at it for an hour or two, yell a lot, swear some, and even laugh a little.⁹ Invariably he would thank me for sharing my time; then he would leave, usually with a smile on his face and (I can’t resist) a twinkle in his eyes.

Although I had much direct exposure to Brown’s pedagogy and style in the thermodynamics classroom, I never felt competent enough to mimic his style. More often than not young professors tend to imitate their professors—subconsciously or otherwise—who taught them the same subject. Perhaps I did succeed in one aspect; I tended to lecture at a fairly high decibel level, for which Brown had been notorious.¹⁰ However, Brown’s principal *forte* was his unique, philosophical approach in presenting the subject matter. Via sheer logic and graphic analogs he was able to write down final forms of generalized equations, thereby circumventing the more formalized and conventional derivations. He emphasized, time and again, that mathematics was to be used as a tool, but not as a crutch, for solving real-life engineering problems. He eschewed mathematical formalism even though he possessed an inordinate comprehension of the subject.

One example of his facility with analogy and reasoning was his quantitative statement of the second law of thermodynamics in a unique form.¹¹ By application of cycles similar to the Carnot cycle to other forms of displacements or transfers undergoing changes in potential or availability, he was able to write a generalized equation as a summation of terms consisting of the product of the quantity of extensive factor undergoing the change and the magnitude of the change in its corresponding (or conjugate) intensive factor. Noting that this summation had the properties requisite of a complete or exact differential, Brown proceeded to demonstrate how the specialized equations of thermodynamics can be written down directly by simply lifting the appropriate pairs of terms out of the summation, which quantified the increase in available energy. In this manner, he would circumvent the much more cumbersome exercise involving “juggling of Jacobians.” It has remained somewhat of a mystery to me why Brown’s availability equation

⁹ I always knew if I was about to strike pay dirt or uncover a raw nerve when he resorted to injecting into our discussion some of his favorite metaphors like: “You’re worrying over the nit on the nut of a gnat” or “It’s a horse of a different garage.”

¹⁰ According to G.B. Williams, A.H. White, who preceded Brown as department chairman, once admonished an aspiring young professor, who could be heard all over the corridors when he lectured, that G.G. Brown was a superb teacher but not because he spoke in a loud voice. Brown not only spoke loudly in the classroom but also in one-on-one discussions. I recall one day when W.K. Lewis of MIT visited Brown in his office. It was my first tour as Brown’s assistant, and I was grading papers in an adjoining office. Brown and Lewis (who was small in physical stature—compared to Brown—but endowed with powerful vocal cords) got into a “friendly” argument over some esoteric point related, I believe, to the thermodynamic efficiency of fractionating towers. As the argument got more heated, the decibel level exploded exponentially, and I was certain that fisticuffs would eventually erupt. Of course there was not even a remote possibility that their animated discussion would degenerate, but I wasn’t sure at the time. I soon learned that although Brown and Lewis were in some respects fierce academic competitors, they had a great deal of respect for each other and, in reality, were good friends.

¹¹ Equation VII, page 520, of “Introduction to Chemical Engineering Thermodynamics” by G.G. Brown, *Transactions of the American Institute of Chemical Engineers*, **34** (5) pp. 489–527 (1938).

(or some variation thereof) never “caught on.” Conceivably it suffers from being deceptively simple, but it always works and it places a premium on common sense rather than rote memory.¹²

Another area of difference between Brown and me was in the first-law energy balance. Brown preferred to consider all thermodynamic systems as closed, with the exception of steady-state flow systems. Accordingly, two first-law energy balances were required as starting points. My preference was to define a so-called generalized system for which only one first-law energy balance was required since it was applicable to all systems, irrespective of whether they were arbitrarily defined as closed, steady state-open, or unsteady-state-open.¹³

Yet another difference between Brown and me was the formalization of the second law. Brown did not dwell on an entropy balance other than the commonplace application to closed systems. To convert the Clausius inequality to an equality, Brown had utilized the symbol w_f to account for work dissipations by reason of friction or “other irreversibilities”—more on this issue later. My preference was to stay with my so-called generalized system approach for the first law mass and energy balances and to derive a comparable equation for the entropy balance. The end result is *similar* to Equation (10) which appeared in our paper (*Chem. Engr. Progress*, **48** (10) pp. 493–496 (1952)). I use the word “similar” because of an aberration. (As printed, Equation (10) is valid only if the temperature at the boundary of the system where heat transfer occurs is identical to the temperature of the system wherein the irreversibilities (lw) occur. Equation (10) can be generalized by simply dividing Q by the temperature of the boundary at which heat transfer takes place rather than the temperature of the system.

¹² Brown and I did have some differences of opinion on the derivation of this equation. I preferred to pull it out of the expanded form of the lost work or entropy production term in the entropy balance equation for a generalized open system.

¹³ In Brown’s approach the first-law energy balance (in grossly simplified form) would be:

$$\text{Closed systems:} \quad E_2 - E_1 = Q - W. \quad (1)$$

$$\text{Steady-state systems:} \quad H_{out} - H_{in} = Q - W. \quad (2)$$

Note that Equation 1 is process-time dependent, only, whereas Equation 2 is spatially dependent only. My preference, was to write one energy balance for what I called a generalized (in a definitional sense) system (based on the accountability principle, input – output = accumulation):

$$(H_{out} - H_{in}) + (E_2 - E_1) = Q - W. \quad (3)$$

For steady-state systems the accumulation, $E_2 - E_1$ goes to zero and obviously, then, Equation 3 reduces to Equation 2. On the other hand, for closed systems, the $(H_{out} - H_{in})$ term goes to zero leaving an equation identical to Equation 1. The basic difference is that Equation 3 leaves the option of treating unsteady-state processes via either Equation 3 or Equation 1, depending on how the system is defined arbitrarily, i.e. either closed (no mass entering or leaving) or open (mass entering and leaving). In the latter case all terms remain in Equation 3. Depending upon the details of the unsteady-state process taking place, the solution to the problem can be, in many instances, grossly simplified by judicious preselection between a closed- or open-system analysis. More elaboration and demonstrations with worked examples are given in the paper which I co-authored with Brown in 1952: “Practical Thermodynamics,” in *Chemical Engineering Progress*, **48** (10) 493–496 (1952). As a “side-bar” note, I had attempted to publish a more detailed version of similar material several years earlier in the mid-forties while I was still a *graduate student*; needless to say I was *annihilated* by reviewers. (Obviously, I was not viewed as another George Bernard Shaw who observed: “Publishers would publish anything that had my name to it.”)

With respect to the terminology, lw , vis-à-vis, w_f , Brown had granted me—several years previously—poetic license, so to speak, to replace w_f with lw . My argument was that w_f or frictional work, carried the very restrictive connotation of two surfaces mechanically rubbing against each other whereas lw opened the door to encompass all types of irreversibilities accompanying heat, mass and work transfer effects in real time.

Needless to say Brown and I had more than a few animated discussions on these aforementioned, “philosophical” (in retrospect, more nearly trivial) differences. His contention—and wholeheartedly (or maybe faintheartedly would be more accurate) agreed by me—was that one can never atone for a lack of fundamental understanding by a simple substitution of symbols (like lw for w_f). I really had difficulty convincing him that what seemed logically obvious to him was not necessarily that transparent to others, especially students and novice instructors. I believe that the final resolution of this issue came as a somewhat reluctant concession by him, in the form of the remark: “If it lowers your blood pressure, run with it.” One of the few times—and maybe the only time—that I prevailed and maybe not for the better as explained below!

Four decades later the tenability of the concept of lost work in thermodynamics reared its ugly head again in a publication, *One Hundred Years of Chemical Engineering* (1989 by Kluwer Academic Publishers). In the chapter, “The Development of Fluid Mechanics in Chemical Engineering,” written by Stephen Whitaker, he chose this inappropriate forum to level an attack (blatant ridicule, to be more precise) on the development of the flow equation in the text book, *Unit Operations*, by Brown and associates. His call to arms focuses on two points: the concept of “lost work” and the derivation of the flow equation. With respect to the former, as I explained above, lw was my invention and therefore I am “entitled to the verbal abuse” since I was *not* one of the associates. With respect to the derivation of the flow equation in Brown and associates (which is conventional, *and correct*, although I prefer to do it differently) I am at a loss to detect any use of, according to Whitaker, kinematic wizardry (which to me implies intellectual dishonesty) in deriving the flow equation.¹⁴

As I was saying, before I was so rudely interrupted by myself several pages back, Brown passed the “undergraduate baton” to me in the summer of 1946, and less than a year later (early 1947) “the graduate baton.”¹⁵ From that date

¹⁴ Although I am (by disposition) very driven to respond in kind to Whitaker’s sanctimonious outburst (not only the items discussed here, but some of his other excursions) this forum provides neither the time nor the place. For this reason, I am surprised that the editors and publishers of that historical document sanctioned this “cheap shot.”

¹⁵ Brown’s passing the responsibilities for graduate thermodynamics to me at this point (early 1947) had to be a matter of expedition rather than an indication of long-range planning. Nevertheless his decision was somewhat of an enigma since he, as chairman of my doctoral committee, was fully aware that I was in the process of wrapping up my doctoral thesis (which had languished for about four years while I occupied myself working on far more exciting—and important—assignments). Because I was not regarded as being in the “tenure-track pipeline,” it was abundantly clear that I would be “heading for the hills” when my current

forward until I left Michigan in January 1955, I continued to be responsible for the two graduate courses in thermodynamics. When I left, Joe Martin, who had been responsible for the undergraduate thermodynamics course and who had a very active doctoral research program in the thermodynamic development of equations of state, picked up the load. (Charley Moesel, whom Brown brought in from MIT in 1947 specifically to replace me in the thermodynamics program, had left after only a few years to take a job in industry.) Joe was the obvious choice, and in my book there couldn't have been a better one. However, since Joe was not an offspring (student) of G.G. Brown, I suspect it follows that upon my departure in January 1955 the G.G. Brown legacy or dynasty¹⁶ in thermodynamics¹⁷ had officially come to an end.

C'est la vie!

academic appointment expired in June 1947. Any further doubts about my future status at Michigan were erased early in 1947 when Brown hired Dr. Charles Moesel from MIT as an assistant professor with the announced intention that Charles was his designee to pick up the load in thermodynamics, presumably no later than the fall of 1947. In addition, Joe Martin was also hired from Carnegie Tech as an assistant professor. Although Martin's doctoral thesis was related to fluid flow in packed beds, he had a greater interest in thermodynamics and applied mathematics.

Despite these prophetic indicators, in the spring of 1947 I received a continuation of my appointment as a full-time instructor, extending to the summer of 1948 (as if—to paraphrase Mark Twain—the reports of my impending demise had been greatly exaggerated).

¹⁶ Admittedly, as I look back, my relationships at times with Brown could be more aptly compared to the comic strip: Beetle Bailey and Sarge Snorkel.

¹⁷ Aside from his two papers, "Introduction to Chemical Engineering Thermodynamics," *AIChE Trans.* **34** (1938), and "Practical Thermodynamics," *Chemical Engineering Progress*, **48** (1952), I'm not aware of any other *general* publications espousing Brown's philosophy of thermodynamics. Gordon Van Wylen's *Thermodynamics* (published in 1959 by Wiley) is not out of "sync" with Brown's philosophy. Although Van Wylen received his graduate degree in mechanical engineering from MIT, he did audit my graduate course in thermodynamics when he joined the mechanical engineering faculty at Michigan in 1951. If any similarities between his outstanding text book and Brown's thermodynamics are purely coincidental, then I can appeal to another correspondence: Van Wylen succeeded Brown as dean of engineering, which "might imply" that *only good* thermodynamicists become deans. Since I never made it to a deanship, I suppose . . . perish the denigrating thought!

The section I co-authored on thermodynamics in Perry's *Chemical Engineers Handbook*, 4th edition, 1963, is the most complete published documentation I have of my approach, most of which I had developed in the 1940s as a student of G.G. Brown and, for the most part, with his approbation. The textbook by Balzhiser, Samuels and Eliassen, *Chemical Engineering Thermodynamics*, which was published by Prentice Hall in 1972 and remained a best seller for a quarter of a century has a distinct Brown flavor and includes many of his favorite problems. However, there is also a very strong Joe Martin bias from whom Balzhiser and Samuels learned their thermodynamics as graduate students at Michigan. For the record, I should include Joe Martin's "thought packages," which he prepared for the American Institute of Chemical Engineers in 1965. This alternative to a text book consisted of about 200, 8-1/2 × 11 overhead transparencies that by way of clever graphical illustrations, equation derivations, and explanatory text, as required, covered most of the basics. In retrospect, if I were now embarking on a career in teaching thermodynamics, I might be more inclined to use Joe Martin's "thought packages" than any textbook available on the market today, particularly for today's students. Despite smacking of pedantry, Martin still leaves ample room for the instructor to maneuver. These charts tell a lot about Joe as a teacher. He was totally organized—almost to a fault; somewhat inflexible—yet not dogmatic; demanding—but compassionate. He was by all measures a student's professor.

AN APPRECIATION OF DONALD LAVERNE KATZ

by James O. Wilkes

Overview of Donald Katz's Life

DONALD L. Katz's 41 years of service in the University of Michigan Chemical Engineering Department are notable for their productivity, vigorous leadership, and imagination in solving engineering problems. He was born in 1907 in Waterloo Township, near Jackson, Michigan, and often referred humbly to himself as a country boy who learned hard work by cutting wood, feeding chickens, collecting eggs, and milking cows.



Courtesy Elizabeth Katz

DLK, age 12, on the farm

“Don” earned his B.S.E. (1931) and Ph.D. (1933) degrees at the U–M. His doctoral dissertation was *The Calculation of Vaporization of Petroleum Fractions*, supervised by G.G. Brown. After three years as a research engineer with the Phillips Petroleum Company, he returned permanently to the U–M in 1936. He served with distinction as chairman of the Chemical and Metallurgical Engineering Department from 1951 to 1962. In 1964, he received a U–M Distinguished Faculty Achievement Award and in 1966 was appointed the Alfred H. White University Professor of Chemical Engineering. In 1971, our department established the annual D.L. Katz Lectureship, which recognizes chemical engineers of distinguished ability in research. Don’s prodigious professional activities and research centered on gas and petroleum reservoir engineering, and on the phase behavior of hydrocarbon systems. He collaborated with 45 doctoral students, and had hosts of co-authors for his 280-odd publications. His *magnum opus* was the *Handbook of Natural Gas Engineering* (McGraw-Hill, 1959), which

summarized much of his previous work.

Don Katz acted as a consultant to numerous industries, and rendered extensive committee and advisory service to governmental and educational institutions. His considerable insight into distinguishing the important from trivial gave a sense of direction and encouragement that is evident in the research of many of his colleagues and former research students.



Donald L. Katz.



Robert B. Bird (University of Wisconsin), who was in 1971 the inaugural Donald L. Katz Lecturer.

Table 5 Donald L. Katz Lecturers

<i>Year</i>	<i>Lecturer</i>	<i>Year</i>	<i>Lecturer</i>
1971	R. Byron Bird Univ. of Wisconsin	1987	Daniel I.C. Wang Massachusetts Inst. of Tech.
1972	Neal R. Amundson Univ. of Minnesota	1988	H. Ted Davis Univ. of Minnesota
1973	Arthur E. Humphrey Univ. of Pennsylvania	1989	Bruce C. Gates Univ. of Minnesota
1974	J.R.A. Pearson Imperial College of Science and Technology, London	1990	J.D. Seader Univ. of Utah
1975	Riki Kobayashi Rice University	1991	Keith E. Gubbins Cornell University
1976	Cedomir M. Slipeceвич Univ. of Oklahoma	1992	Matthew Tirrell Univ. of Minnesota
1977	Rutherford Aris Univ. of Minnesota	1993	Stuart W. Churchill Univ. of Pennsylvania
1978	James W. Westwater Univ. of Illinois–Urbana	1994	Richard M. Felder North Carolina State Univ.
1979	Robert S. Schechter Univ. of Texas–Austin	1995	Robert A. Brown Massachusetts Inst. of Tech.
1980	Lawrence B. Evans Massachusetts Inst. of Tech.	1996	Edward E. Cussler Univ. of Minnesota
1981	John H. Seinfeld California Institute of Tech.	1997	John M. Prausnitz Univ. of California, Berkeley
1982	Thomas F. Edgar Univ. of Texas–Austin	1998	Centennial Symposium (No Lectureship in 1998)
1983	Joe D. Goddard Univ. of Southern California	1999	Douglas A. Lauffenburger Massachusetts Inst. of Tech.
1984	Alexis T. Bell Univ. of California, Berkeley	2000	Donald R. Paul Univ. of Texas–Austin
1985	John A. Quinn Univ. of Pennsylvania	2001	Alice P. Gast Stanford University
1986	L.E. Scriven Univ. of Minnesota	2002	Klavs Jensen Massachusetts Inst. of Tech.

SECOND

$f(f(x)) = x^2 - 2$
Find $f(x)$

LECTURE

BY

U. OF MICH.
15 APR. 1971

Refs: J.G. KIRKWOOD, "Macromolecules", Gordon & Breach (1967)
 R.B. BIRD, H.R. WARNER, D.C. EVANS, Adv. Polymer Sci, Vol. 8, pp 1-96 (1971)
 [these refs. contain many original literature citations]

BASIC EQS. FOR DUMBBELL KIN. THEORY

① Eq. of motion:

$$m \ddot{\underline{R}} = -\zeta(\dot{\underline{R}} - [\underline{K} \cdot \underline{R}]) - 2kT \frac{\partial}{\partial \underline{R}} \ln \psi - 2\underline{F}^{(c)}$$

② Eq. of continuity:

$$\frac{\partial}{\partial t} \psi = - \left(\frac{\partial}{\partial \underline{R}} \cdot \dot{\underline{R}} \psi \right)$$

③ Stress tensor

$$\underline{\tau} = -\eta_s \dot{\underline{\gamma}} - n_0 \langle \underline{F}^{(c)} \underline{R} \rangle + n_0 kT \underline{\delta}$$

Summary of Some Results

STEADY SHEAR FLOW

OSCILLATORY SHEARING MOTION

STR. RELAX. AFTER CESSATION OF ST. SHR FLOW

ELONGATIONAL FLOW

Definitions:

- n_0 = number of dumbbells per cc.
- η_s = solvent viscosity
- ζ = bead drag coeff = $6\pi\eta_s r_0$
- r_0 = bead radius
- m = bead mass
- H = Hooke Law const for $\text{---}\text{---}$
- L = length of $\text{---}\text{---}$
- \underline{R} = vector from bead 1 to bead 2
- $\psi(\underline{R})$ = probability density for orientation \underline{R}
- $\langle \underline{Q} \rangle = \iiint \underline{Q} \psi(\underline{R}, t) d\underline{R}$
- \underline{K} = const. tensor in $\underline{v} = [\underline{K} \cdot \underline{t}]$
- $\dot{\underline{\gamma}} = \nabla \underline{v} + (\nabla \underline{v})^T$ = rate of deformation tensor
- $\underline{\delta}$ = unit tensor
- $\lambda = \zeta L^2 / 12kT$ ($\text{---}\text{---}$); $\lambda_1 = \zeta / 4H$ ($\text{---}\text{---}$)

Handout from Prof. R.B. Bird (University of Wisconsin) at the inaugural DLK Lecture (2nd day) in 1971.

Always deeply interested in all aspects of teaching, Don's research led to stimulating classroom presentations. He was a pioneer in the applications of digital computing in engineering education, and from 1959 to 1963 he spearheaded a large project, sponsored by the Ford Foundation, that drew worldwide attention to this area.



Riki Kobayashi, Donald Katz, and unidentified, late 1940s.

The professional and educational work of D.L. Katz has been recognized by numerous major awards, including three from the AIChE: the Founder's Award (1964), the Warren K. Lewis Award (1967), and the Walker Award (1968). He served as president of the AIChE in 1959, and was elected a fellow of the National Academy of Engineering in 1968. In 1983 President Reagan bestowed on him the National Medal of Science, the federal government's highest honor given to scientists and engineers. He was cited for his pioneering work in the processing and storage of petroleum and natural gas.

In 1983, Prof. Katz was also selected as one of the 30 "Eminent Chemical Engineers" by the council of the American Institute of Chemical Engineers and was further honored when the Donald L. Katz Award was named after him in 1985 by the Gas Processors Association. He was a consultant to countless private firms and government agencies.

He first married Maxine Crull, who died on 7 March 1965. On November 26, 1965 he married Elizabeth Harwood Correll, who survives. Dr. Katz enjoyed many hobbies, which included his flower garden and writing family histories. Katz was a local history buff, and also wrote a book on the settling of Waterloo, Michigan, for which he received a Merit Award from the Michigan Historical Society. He was a longtime active member of the First United Methodist Church of Ann Arbor

and served as a member of the Ann Arbor Board of Education from 1948 to 1957, serving as president for three years.



James Wilkes

Donald Katz and University of Michigan President Robben Fleming, bringing congratulations from the Board of Regents on Don's professor emeritus title. Horace H. Rackham Building, just before the DLK lecture by Rutherford Aris, 15 April 1977.

Don Katz's Retirement

The most significant departmental event during 1977 was the retirement, after 41 years of service on our faculty, of Donald LaVerne Katz, A.H. White University Professor of Chemical Engineering.

Don was honored at a two-day lecture and open-house program on 14 and 15 April. The events included two lectures on "Mathematical Modeling" by Rutherford Aris, chairman of the Chemical Engineering and Materials Science Department at the University of Minnesota, and recipient of the 7th annual D.L. Katz Lectureship. Then, with a large audience, Don presented a special lecture on "Experiences in an Industrially Oriented Engineering Education Career." His talk was well illustrated with several examples of direct contributions to industry that had resulted from his own research and that of his many students.

Don's lecture was a superb technical presentation. One was forced to wonder how many other chemical engineers *at any time* could have drawn on such a wide range of experiences, spanning so many years, and simultaneously of such great

interest to academia and industry. Certainly the audience agreed, and Don evoked an exceptionally warm response.

On the evening of the second day there was a large gathering of Don's friends, including many from out-of-town, at a special dinner at the Michigan League. Several presentations were made. Larry Van Vlack, on behalf of the former Chem & Met Department, delivered Don the original hand-lettered sign that had hung for 11 years outside Don's office when he was chairman. From Fred Poettmann, for the alumni, came a large book of testimonial letters and other memorabilia. The Michigan Gas Association bestowed a plaque, bearing Don's portrait, and a citation. Chairman Jim Wilkes, speaking for everybody, presented him with an engraved sterling silver bowl and an engraved brass mantel-shelf clock. Don responded with some more well-chosen words, and we were all proud to have participated in such an enjoyable and memorable event.



Elizabeth Katz

After Don's death in 1989, numerous tributes followed. University of Michigan Provost Charles M. Vest noted: "Donald Katz was also a very warm and interesting human being. He was always keenly aware of his rather humble origins and ever thankful to those who helped him become educated and rise to the top of his profession." Interim Engineering Dean Daniel E. Atkins III said: "His is a story of high energy, high goals, high aspirations and leadership. Donald Katz was one of the college's most distinguished professors, and he had a profound impact on his profession, his department, the college, and this university. He was an inspiration to us all." H. Scott Fogler, then chairman of the U-M Chemical Engineering Department, added: "We've lost a giant. His contributions to the department have just been enormous. Don was a role model in everything he did: as a teacher, a researcher, a colleague, and a friend. He has left his everlasting imprint, not only on the U-M, but on the chemical engineering profession as a whole." After his retirement from the U-M, Don Katz maintained a full range of professional activities, continuing to be a prolific author. Days before his death he was still making corrections on the text of his last book, *Natural Gas Engineering Storage and Production*, co-authored with Robert L. Lee, which was

published by McGraw-Hill shortly after his death at his home on 29 May 1989, at the age of 81. Prof. Katz honored the College of Engineering by endowing the annual Donald L. Katz Lectureship, which was established in 1971 to bring internationally recognized chemical engineers to campus. Additional uses of this fund may include fellowship support for graduate students and funding for research

projects in chemical engineering. All previous lectureship recipients are listed in Table 5.



Arthur E. Humphrey (Univ. of Pennsylvania), 1973 DLK Lecturer, with Donald L. Katz.

REMINISCENCES

by Donald L. Katz, 1987[†]

Return to the Department

WHEN I returned to the department from Phillips Petroleum in 1936, I expected to be an assistant professor for the traditional period of six years. But they had promoted some other people in the same time that hadn't been doing very much, so were still following the book, so to speak. Even when I was promoted to associate professor, I was still getting an assistant professor's salary. But I didn't mind too much, because I was writing papers and doing things. The war had started, you see, and people had left. They were reserve officers and went to the military, so there were many things for me to do that needed to be done. I was getting responsibility for graduate students, and for programs of research and so on. I did them all, so that in 1942 I was head of the graduate committee.

I think that I was only an associate professor one year before I was made a full professor. Professor White, who had a long career from 1898 onwards, retired in 1942, but he had left Professor Brown to become the chairman of the department in 1941, a year ahead of time. I had written up a summary of his career and put

[†] Excerpted and edited from a series of interviews conducted by Enid H. Galler, Voice Treasures, 1056 Ferdon Rd., Ann Arbor, MI 48104, September 1987.

on a birthday party for him with 300 people in the dining room of the Michigan Union. People came from all over the country, including Sidney D. Kirkpatrick from McGraw-Hill's chemical engineering series of books, who spoke at the dinner. He had just been president of the American Institute of Chemical Engineers. We had our 50th anniversary as a department in 1948. I became professor during the war, and we went to the three-semester system, during which I taught around the clock. I had a goodly number of graduate students working at the time, mostly people who had poor health of some kind, and were not in the armed services. We had some folks who came in other capacities, those who were doing work at the university and were also students. It was that way through the late forties and early fifties.



Donald L. Katz, 1938

more interest in the materials, the metallurgical aspect, than most other people did, because I was teaching materials when I first started teaching. I had projects in materials, as well.

Brown was appointed to the vacant deanship position in April 1951, still retaining chairmanship of the department. I went to Oak Ridge for eight weeks that summer, and I knew there were some questions about how to select the new department chairman. I wasn't too worried about it, as long as they didn't pick somebody that I thought was pretty bad. I went to Chevron, Standard Oil out in California, and was giving lectures there when I got a wire from Brown saying that I had been made department chairman. I knew the chairmanship involved a lot of administrative work, but the important thing was that I knew I was accepted by most of the people, and there weren't many people that the same could be said of in the department, which was both chemical and metallurgical. I had

Overseeing the Department

Although I had never really been a chairman of a group, I had overseen some pretty good-sized projects. I had a project for the American Petroleum Institute in the 1940s, where I was organizing for a safety program called "Design and Construction of Pressure-Relieving Systems." It was in 1946–1947 that I wrote that monograph for them. We went to 30 petroleum refineries and high-pressure gas plants in the country. I met chief engineers and many other people, including the chief engineer of Bechtel, whom I had never heard of until I went to California. He had a fancy office and, of course, I later found out what a giant company they were, but not in the chemical area. It was a great opportunity for doing these

things. We went from Oklahoma to the Grand Canyon to the Los Angeles area, where we inspected oil refineries and rubber plants, and then to San Francisco and Richmond, where we saw other plants, and then we went on up to see the sawmills in Washington, and Longview, where a former student of mine had worked. We came back through the Rocky Mountain National Park. It was a great time for us to do things of this kind.

During the war travel was shut off unless it was business, and half of that was waiting in an airport. Then a colonel got on and took your place.

I liked being chairman, in the sense that I could serve people, but I realized that it was going to be difficult for me to come back and do quite as much research. You finally end up by being kind of a policeman. I had people who were dragging their feet. They didn't do much in terms of research or making other progress, and so I'd have a meeting with them, once a year at least, and sit down and go over what their plans were, and their program. Then later, we'd come and ask how much of this they had done, and find how well, and the next week you had to decide how much of a raise you were going to give this person. I tried to run an open meeting. At the table where we were sitting for lunch, I passed around my proposed raises for everyone. They could all see them before I sent them in.

Previously, the setting of raises had pretty much been a closed book. I did some of this with Brown before he gave up his seat. He was traveling a lot, too. Actually, he was once director of research for the National Dairy Company in Long Island, while he was still listed as chairman for us. Professor Brier or Upthegrove, or somebody was minding the store, and he had a committee, of which I was a member. The department was very good to me. We tried to be good with the students, having social occasions where the wives of students were included, and faculty people—bringing them here to the home, or wherever we could take them.

Changes in the Department

During my years, the department changed from being of the old school. For example, Professor A.H. White had started a program when they built the East Engineering Building in 1923, in which they expanded the number of our doctoral students. We had the largest group of doctoral students, probably even more than MIT for two or three years, about 1930. I was on a doctoral committee for one of A.H. White's students. It was that if you spent two years on your thesis, you were ready to get your degree. This student handed in his problem solution that was awful, just awful. I said, "Why didn't you talk to the members of the committee?" His committee wasn't appointed until he handed his thesis in, so there was no contact between the committee members, the student, and the chairman of the committee, or supervisor. I brought up a statement that times needed to change. We should appoint the committee when he starts the problem, meet with the committee and the student and the ideas that the committee people have, can

help him for a statement of what his problem is and what he is going to do. Then when they're all through, they can't complain that he didn't do something because they didn't tell him when he started. That's what happened. Things like that went along.

We had changes from then on, including dropping a lot of the engineering industrial aspects. At one committee meeting when I wasn't present, a statement was made that we should abolish all industry-related courses. I wasn't there, but somebody else objected—I think it was Dr. Tek, and they didn't do that. But we had had many courses in oil and refining. I started one on oil production when I came home from Phillips in 1936. The pendulum swings in engineering education. During my latter years it swung toward the mathematical aspects, and when I finished in 1977, and I wrote my farewell address, it was *Experiences of an Industrially Related Educational Program*. I believe in solving the problems that industry has, but doing it in a basic way. Half the theses out of my 54 were problems that I'd learned needed solutions while I was working in industry.

Even now, they're dropping what we call the process end of chemical engineering, which was the backbone of engineering in the 1950s and 1960s. How to build big oil refineries or synthetic rubber plants and all this high-octane gasoline, and many chemicals that come down the line—fertilizers and so on. Now they're looking at what *can* they do? Because they know chemistry and engineering, can they make better electronic materials now, and they are into biotechnology. We had a faculty member, Lloyd Kempe, who worked in biotechnology and sewage and waste disposal, and in the production of certain biological materials—corn syrup and alcohol, and things of this kind.

We expected new things to come along. We had a paper industry group here, and it wasn't very good and finally disappeared. That was started in 1930, in Wisconsin, and they had courses here given by Professor McCready. They built a special laboratory for him to have humidity control, which you need to have when you are working with paper products. We felt the swing, and the swings are usually related to people, as you know. Some people make a big swing and it sticks, others make a big swing and it doesn't stick.

A.H. White University Professorship

I was made one of the twelve distinguished university professors, and given a name related to somebody in the faculty, usually in earlier years. I chose the name Alfred Holmes White for my university professorship, in good part because he was one of the old-school classical gentlemen who still was enterprising and did things in research. He had been doing research on Portland cement for 40 years. He had cement bars in the basement. He had them wet for six months, and dry for six months, and he watched the growth as all the wetting and drying took place. That has to do with highways, which used to rupture because they were growing with

the wetting and drying. They put in the plastic asphalt dividers, in sidewalks and other places to keep that from happening, and he showed how it happened. White was also a gentleman. His folks were educated people in the Illinois area.

When we came here in 1936, A.H. White and his wife invited us to their home for dinner. They treated us as friends and as professional people. My appendix ruptured in 1941, and White made sure that someone in the faculty came and looked after my wife's furnace—a coal furnace in those days. He didn't come to see me very often, but he asked each day to find out how I was. I was not getting well, and so he went out to a place to look for some new medicine. Sulfanilamide was being given to me, and it wasn't working. He found there was something new, sulphathiazol, and he got some for my doctor to use for me. I had a violent reaction at the transition from one to the other. It started my cure, but it was almost fatal, too. He looked after me. When it was time for me to come home, he came to get me and took me home.

A.H. White and his family were always good, and we tried to correspond by being that way to them as they grew to be 80 years old. A.H. and his wife had their 50th wedding anniversary in July 1953 and we had put on an 80th birthday party for him in April that year. In August, while we were off in the Bamph area of Canada, we got a wire that he had died—at his desk, writing a book that he had hoped to coauthor with his son, who sadly had died the day before I came back in 1936. He could criticize you nicely, in a way that you accepted it as a professional gesture, trying to make you a better person.

I admired A.H. White a great deal. He did both research and reasonable teaching and knew how to manage. He had a seminar for the graduate students and for the undergraduate students. He was there to handle it each week. We knew what was going on. He looked after the students. When they built the East Engineering Building, he wanted a big, large room so the graduate students could all get in there at once. The building man said we couldn't have a room that large, so we wanted to know why not. Well, the building people say you can't have one that big. So he said, "Oh, okay." But he managed it so that the building was built in sections. He put half of the room in this section, half in the other section, and you could open the doors between and have enough room for our seminars. So we could hold 100 people in the room. It was very serviceable for student affairs, for lunches and all kinds of things. But he was really capable, too, as a manager, and as a scholar. He was president of AIChE in 1929 and 1930, I believe.

Professional Societies

Throughout my career, I was very active in professional societies, probably the most important of which was the American Institute of Chemical Engineers. AIChE started in about 1908, and I joined in about 1936, when I came back to the university. I had the tradition of A.H. White, the chairman, and G.G.

Brown. At the same time that A.H. White was president of the AIChE, Professor Gomberg was president of the American Chemical Society, and I was aware of this as a student. At Michigan, we had the first student chapter of the AIChE. As a sophomore, I started going to the AIChE meetings and became acquainted with it. When I went to Oklahoma to work, I did not become involved with the chemical engineers, because they were petroleum engineers. They were a division of the American Institute of Mining, Metallurgical, and Petroleum Engineers. I became active in their local sections.



Stuart Frey

Eugene C. Sullivan (vice-chairman of Corning Glass Works), Donald L. Katz, and Alfred Holmes White, during the 50th department anniversary celebrations, 8 May 1948.

Actually, my thesis paper was published in the American Chemical Society's *Industrial & Engineering Chemistry* magazine. In the petroleum group, in 1933, I went to Dallas to my first Society of Petroleum Engineers (SPE) meeting. Over the years, I went to both groups' meetings (SPE and AIChE). I have only missed three of the SPE meetings in 54 years. We'll be going to one in Dallas, later this month (1987). It so happens, that my son, Marvin, who worked in petroleum, was president of the SPE. I never had any official position in its management; I was only involved in the technical papers.

In the AIChE, I became involved as student-chapter chairman. That is the managing of the 80 or 90 student chapters in the country at that time. We'd have a contest going for the students to solve problems, and we began having activities at the annual meetings for student chapters. We gave awards at the annual meetings.

In 1951, I worked at Oak Ridge and became involved in the nuclear industry, and found that the nuclear-processing people had not been involved in the AIChE as much as they might have, so I started the organization of a Nuclear Division of the AIChE, which was accomplished by about 1954. We held here the first meeting in the world of nuclear people after the secrecy was removed from much of the work done. They came here, 120 from other countries, and a total of 1,200 attended the meeting. I was chosen chairman. Well, things went on in the AIChE. I helped them with the heat-transfer division organization.



James Wilkes

Home of the Donald L. Katz family, 2011 Washtenaw Avenue, Ann Arbor, Sept. 1955.

For 1954, 1955, and 1956, I was elected to the 12-member AIChE Council. We had maybe eight meetings a year nationally of the council. We went to the meetings and we were running the business. We had a national office in New York, and a secretary who ran the affairs. The nominating committee put me on in 1957 as one of the two candidates in an open election for vice-president. I was elected, and the annual meeting that year was in Cincinnati. My wife Maxine and I, daughter Linda, son Marvin, and daughter-in-law Sue, all came to the meeting in Cincinnati, at which I was inaugurated as the vice-president of the institute. This meant that for the next three years I would go to the executive committee meetings as well as the council meetings, and was automatically elected president of the institute. As president, you are expected to travel to local sections and meet with them, and student chapters as well. During that year, 1959, I was absent from Ann Arbor 82 days. Many of these meetings, though, were held on weekends, so it wasn't quite all working time. It was an interesting thing, getting to know many people. We

made a trip to Florida and stopped for two or three weeks, and spoke at maybe a dozen meetings going down to Florida and back through the mid-continent.

One of the things we did at AIChE was to have more divisions in the institute, reflecting the growing number of our members, then up to some 15,000 to 18,000. We also participated in the construction and building of the United Engineering Center, in New York City, opposite the United Nations. I was privileged to go there representing the AIChE and turned the traditional spade of dirt. I was the second on the list, because of the alphabet, but Herbert Hoover turned the first spade and I had my picture taken with him as well. We did other things. We decided to have a study made of dynamic objectives for chemical engineering as a profession. I started it with Robert White as chairman, but he sort of took on another job, and decided he shouldn't carry it out, so I came back in my past-president year, and chaired that section. The study on dynamic objectives was really to find out what we ought to be doing as chemical engineers in our society. That included the curricula of schools as well, because we were also managing the accrediting procedure for chemical engineers. It was part of our growth process. It guided our group for another ten years or so. It was really one of the outstanding things in your career, to have this privilege, because I had become known then to the chemical engineers. And people came for our 50th anniversary meeting—from Russia, for example—to represent their societies, and I met the heads of their chemical engineering groups in Russia. And from England, where they have their own society. We had lots of nice experiences and got acquainted with a large number of people.

The AIChE has changed mostly through growth in the breadth of its activities. There are maybe 14 divisions now, including bioengineering and genetics, that sort of thing. We have one in the field of computing, and even in sales, now—in the selling of chemicals. We have a group that is close to a total of 50,000 members. I've had several former students who became president after me. One, Johnny McKetta, became president two years after I was. He was my vice-president, you see. I became acquainted with people who were presidents of companies, and chairmen of the board, for example of Gulf Oil. It put me in touch with the other engineering professions, so that I was acquainted with the mechanical, the civil, and the electrical engineers, as well as the chemical. I was the third president of the AIChE from our department.

In the Society of Petroleum Engineers I was a party to the growth of their activities. I actually ran the 1943 meeting (the only one during the war), because I was the one person who was available. I got my reputation in the petroleum field through the papers that I wrote. The meetings were always held in the southwest, from San Antonio and Denver to Dallas, Houston, and New Orleans. The contacts also led to job openings for my students. Many of my ideas for research came from the petroleum industry, from such meetings, and many of my people went there

and have been active in the SPE.

I belonged to about ten societies. One of them is the American Gas Association. In more recent years, I worked with them doing research at the U–M. I wrote three monographs—on the movement of water in contact with natural gas in the reservoirs, on threshold pressure (the amount of pressure it takes for gas to push water out of the cap rock), and the last one (in 1975) had to do with retrograde condensation in natural-gas pipelines. I also worked for a while with the American Society of Mechanical Engineers in the field of heat transfer. In the American Society of Engineering Education, I went to some of their meetings and wrote a few papers.

I joined the American Nuclear Society when it was formed at the Ann Arbor meeting, back in 1954. I went to their meetings some, but not too much as years went on. I belong to the National Society of Professional Engineers. These are registered engineers. I had some activity with them, but not too much. In 1968, I was elected to the National Academy of Engineering, in Washington, and my wife and I started going there regularly to meetings. We've been there nearly every year since. It was for the leading engineers of the country. You met the top people, fellows like Von Braun, the rocket man, and other prominent people, many of them presidents of companies.

The National Academy of Engineering is a group affiliated with the National Academy of Science. President Lincoln chartered them in 1863, and the charter has been broadened to include the engineering and medical groups. There is an institute of medicine, so there are three groups under one umbrella. They operate the National Research Council, which does millions of dollars worth of research, mostly for the government, like highway research, all kinds of things in the medical field, and even in space. It is really the top engineering organization in the nation. We have annual meetings, and they also write papers and organize to get people to become committee members in the National Research Council.

In 1972, I worked with Ed David, who was the science advisor to the president of the United States, and Richard Balzhiser, who was his assistant. We put on a meeting in 1972 that was recommending priorities for the government's budget allocations for science. We put on a meeting at Saxton River, in Vermont, in the summer of 1972. We looked at eight kinds of energy—nuclear energy, fossil fuels, and several others. We had 150 people who were the top people in the nation. I was associate to the director of the group and I was also the recording secretary, to see to it that a report was made. This was for budget-making purposes, which comes out of the Office of the Advisor to the President on Science Affairs.

In addition, there is the National Science Foundation. I was working with them on occasion. They helped me with projects at the U–M, and I've been on committees with them. This is another area where one can contribute to committee work. I also am a member of the American Association for the Advancement of

Science, a fellow for the group. They send out *Science*, a weekly magazine, and you have a lot of communication with them. I've been on their committees some, but I've never been too active.

The American Chemical Society (ACS) was one of the first that I joined, in 1932. I was active with committees for them. I became acquainted with many of the officers of the ACS through their journals, including *Industrial and Engineering Chemistry* and *Chemical Engineering News*. I was on an advisory committee for the latter. Over the years, they had asked me to join in certain studies, and I have done it.

The Gas Processors Association is an organization in Tulsa, where they look at taking the gasoline that comes with natural gas out of the earth, and putting it into liquid form and selling it as natural gasoline that goes into motor fuel and also propane and butane, which are LP gas, put into cylinders for house cooking or heating. Dr. Brown had been working with this association just before I joined him as a student, in the 1920s. He did work with fuels for them, and so I was acquainted with them. When I went to work for Phillips, I went to their meetings and spent quite a lot of effort with them. I worked a couple of summers on projects in the field, testing wells, doing things that they needed to have done. I presented a goodly number of papers through their group. They are a special group of people who are a mixture of the companies that operate the plant, and the committee system that they have for gathering data and putting the information before the public. In 1986, they established the Donald L. Katz Award. It was for people who make contributions in science research for the light hydrocarbons, and people who contribute in education and bring them engineers that they need in their work.

Awards

I have been fortunate enough to receive some 23 major awards, which are listed in Table 6. I consider that being president of the American Institute of Chemical Engineers is the top award, also being elected to the National Academy of Engineering, in which there were only 300 members in the nation when I was elected, and they're the top engineering organization. Having awards named after you is something very special (the annual U–M DLK Lectureship and the Gas Processors Association DLK Award), and I appreciated that. When I received the Murphree Award, one of my students, Cheddy Sliepcevich, compiled a beautiful book and made a few copies for us to have, called *Following in the Footsteps of Professor Katz*. It lists my doctoral students, and the people that came to the meeting also presented papers in my honor in Philadelphia.

The National Medal of Science was of course a very special award. The White House science advisor called and told me, and it was a wonderful experience.

Table 6 Principal Honors and Awards of Donald L. Katz

<i>Year</i>	<i>Award/Honor</i>
1950	Hanlon Award, Gas Processors Association, Tulsa, OK, for aid in understanding separation processes and reservoir behavior.
1959	President, AIChE (American Institute of Chemical Engineers).
1959	Michigan Engineer of the Year, from the Michigan Society of Professional Engineers.
1962	Distinguished Lecturer, Society of Petroleum Engineers.
1964	Carrl Award, Society of Petroleum Engineers.
1964	Distinguished Faculty Achievement Award, University of Michigan.
1964	Founder's Award, AIChE.
1967	Warren K. Lewis Award, AIChE, for abiding interest in students, leadership as chairman, U-M Chem. & Met. Eng. Dept., and innovations with respect to computers in education.
1968	Elected to membership, National Academy of Engineering.
1968	William H. Walker Award, AIChE, for contributions to chemical engineering literature.
1969	Honorary Member, Phi Lambda Upsilon, honorary chemical fraternity, for distinguished achievements and leadership.
1970	Mineral Industries Award of AIME, recognizing an eminent educator, author, and engineer.
1971	Donald L. Katz Lectureship established at the University of Michigan.
1972	Distinguished Public Service Award, U.S. Coast Guard, for inspirational leadership of the National Academy of Science NRC Advisory Committee on Hazardous Materials, 1964–1972.
1975	E.V. Murphree Award, Industrial & Engineering Chemistry Division of the American Chemical Society, for publications in petroleum processing, oil and gas reservoir development, and elucidation of physical properties of hydrocarbons.
1977	Gas Industry Research Award, American Gas Association, for significant contributions to gas industry research technology.
1978	Anthony F. Lucas Gold Medal, AIME, for distinguished contributions to hydrocarbon phase behavior and petroleum reservoir performance.

- 1979 Award of Merit for book *Settling of Waterloo, Michigan*, from the Michigan Historical Society, for contributions to local history.
- 1983 Selected as one of 30 “Eminent Chemical Engineers” by the Council of the AIChE on the occasion of the institute’s 75th anniversary.
- 1983 Received the National Medal of Science from President Reagan at a White House ceremony for a group of 12 recipients.
- 1984 Designated by the board of directors of the SPE as “SPE Distinguished Member.”
- 1985 The Donald L. Katz Award established by the Gas Processors Association for research and academic personnel.
- 1986 Elected an Honorary Member of AIME.
-



President Ronald Reagan presenting the National Medal of Science to Donald L. Katz, the White House, 24 May 1983.

Twelve or so of us attended—family members and the chairman of the department. We had a dinner the night we arrived at the National Academy of Sciences. The

next morning they came and got us and at about 11 AM took us to the White House in limousines. They had the red carpet out for us to walk into the back side of the White House. We went upstairs and the Marine quartet was having a recital for us. We met in the East Room and then the president came in for about 9 or 10 minutes. There were many prominent people there, including cabinet members. The president made a little speech and went out. It was, of course, the best honor I had ever expected to receive. It was a wonderful thing. There are about 12 a year that get the award now.

Public Service

I was on many public-service committees. That's partly an outcome of being president of the AIChE. As you go on to committees you become acquainted with other people in other disciplines. The one from the Coast Guard came from the National Academy of Science and Engineering, through their National Research Council. I was asked to chair and organize a committee, in 1964, to study and help the Coast Guard to handle hazardous materials. That means flammable materials, especially like propane and butane in pressure tanks. It meant handling marine fires, but mostly the chemicals. The Coast Guard has to approve ships that come with chemicals, not only from overseas but on barges along the coastline and intercoastal canals, the Mississippi River, the Ohio River, and so on. We had to classify the chemicals for hazards and various qualities: harmful to the body, likelihood of fire, and vapors that are bad if inhaled, etc. So I organized the group and got the best people industry and universities and government who would come and sit and do things that you couldn't hire them to do, because they weren't available for hire. But they would do it for free. So we put out material, which the Coast Guard could use in contact with industry, and industry people could put in their ideas to the Coast Guard through us. We screened them, and we were able to get technical knowledge from industry into the hands of the Coast Guard to use for safety purposes. Everybody is really interested in safety; it's just a question of getting the right kinds of rules and regulations.

The Coast Guard showed us how our advice was actively being used. We went to Coast Guard installations to see things. We made field tours. We went through the Houston ship canal, we went through the Port of New York, the Port of New Orleans, to Mobile, Alabama. We saw what they were doing and we helped them. One of the things they were putting together was an information system, so they could put information on file and help the people as they were operating a port.

Another public-service board involved stack-gas cleaning for power plants, in 1975. I chaired a committee with several prestigious members. One of them was Eddie Kahn, the man who later was Jimmy Carter's price-control man. He was our economics man on the committee. I had a man who was a former head of the Bureau of Mines. I had a director of research from Universal Oil Products

Company. We put together a report on the need for stack-gas cleaning to take the sulfur out of the air, and there was a discussion on acid rain which, even now, is said not to be settled. We thought we settled it in 1975, but the government people somehow drag their feet on something like that! But we saw it coming, understood it, knew where it came from and had it in our report.



Bob Kalmbach

Robert S. Schechter (Univ. of Texas), David V. Ragone (dean of the U-M College of Engineering), and Donald L. Katz, April 1979.

I was on a committee of the Commerce Department for studying the effects of lead in gasoline, whether we should take the tetra-ethyl lead out of gasoline or not, and what it would cost. So I met with the presidents of some of the oil companies, like Chevron, having them make a presentation to our committee of what change it would have to make in refineries if they took the lead out. Of course, the lead was an economical way of making gasoline. They never could really put their fingers on it, but they knew that lead was bad for people. We found out, for example, that the worst place for causing harm to people might have been where the people worked in muffler shops. Much of the lead resided in the muffler exhaust system that they took out of old automobiles, or when they repaired them. It is clear that there was a lot of lead along the highways, so we suggested that it be phased out slowly. It has been now, down to practically nothing. Dr. Ragone, who was a dean here afterwards, one of the young men in our department, was the chairman of the committee that I worked on.

Computer Initiatives

One of the things in education that came on the horizon in the early 1950s was the use of electronic computers. Gradually, the university got a computer, and our graduate students learned how to do it, and actually operated the computer themselves. In due time, I discussed the use of computers in industry with a man from Esso Engineering. I asked him how long it would be when one of our students started working for him before he would be involved in using a computer, would it be five years, one year, two years? He said, “Why don’t you say, two months?” Because, he said, all of his people became involved with computers. We didn’t do anything to prepare our students for using computers. So I started making inquiries. We had a couple of people in our department, Sliepceвич—but he had left us by that time—Martin and some other folks, and we knew that the Computing Center had people. Dr. Bartels was the chairman, and Dr. Galler was one of the people on the committee. These folks were glad to talk about it.

We organized a group that might demonstrate the use of computers in solving an engineering problem in chemical engineering. The first meeting was on a February evening and we announced that we were going to discuss computer programming on a Tuesday night. They came, 230 of our people came, on an icy, slippery night. It became obvious that they were interested! We provided lectures on programming and had someone who put on an example problem and its solution at Rackham. We said, “Well, we really ought to do something, not just have a little session like this. Why don’t we get a study made to educate our faculty?” You see, the faculty didn’t know how to use computers themselves.

One of the people from the Ford Foundation visited us about that time. We told them we were getting a committee together in the department and we asked them to help us, really to buy time for the faculty not to teach, but to learn how to use the computer. So we came up with a budget of \$200,000, and submitted a draft of our proposal to the Ford Foundation. They came back and said they would give us \$900,000, but we had to enlarge our program for the nation. Go to dozens of schools, offer it to the whole nation, engineering schools in all branches. So we did, and in the fall of 1959 it was awarded to our committee and us. During the three-year project we brought in 150 engineering faculty from other schools, as well as some of our own, and taught them how to use a computer. We let them come here for a semester or a summer, with the expenses paid.

I visited the major schools in the nation. I went to MIT, Wisconsin, Ohio State, Berkeley, Texas, Georgia Tech, New York University, and places like that. We made this presentation that we were going to put on this program; would they consider sending us people, and would they help us along the way. I found at that time that there was virtually nobody who had an example engineering problem that they had given their students. I found only one example of that in one of my stops at various schools. So we put on, I think in the spring of 1960, and had

maybe 20 people come here and 15 of our own, who were paid for their time to do this for a semester. This is the way it went on for three years; summers were always a larger number, but it was only eight weeks, full time. I did such things as even going around to rent apartments for 20 people coming who needed a place to stay.

At the end of the first year, we put out a report, giving example of problems that people on the course had solved. The second year, we did some more of that, and the third year we had a final report, which was sent to every professor in the engineering schools of our country. It was sent abroad, to all the engineering schools of the free world. In 1963, I went to Buenos Aires, in Argentina, to visit the dean of the engineering school there. I didn't think much about it, but he asked me to meet the young man who runs their Computing Center. I met him, and he was just tickled to death to see us, because he was using our report that we had sent him. We did make a mark around the world with this.

After this computer project we were asked to establish the Computer Policy Committee for the U–M. I visited the departments, found out all about the computers—where they were, who did what with them—and we tried to handle questions as to whether when they bought new computers we should enlarge our large computer system or let them have a small one they claimed they needed. I started that and did that for a couple of years.

The National Science Foundation subsequently provided the support for a follow-on project, which we used to demonstrate the use of computers in design work in the engineering field. This was a project that involved a large number of people, and it was an activity that I enjoyed doing. But I never considered myself a computer expert, only a promoter.

Possibilities at Other Universities

I occasionally considered moving from Michigan. I had two invitations that sounded fairly good, so I investigated them. The first one was about 1962. I went to Raleigh, North Carolina, North Carolina State, where the engineering school is. I saw a great challenge there. The president, however, was not much acquainted with engineering. He didn't have any concept that a professional engineer did the sort of things I did. So I said to him, "You know, one of the things I'll do, that maybe you're not used to, is that I would do quite a bit of traveling. You should recognize that a professional person and a person of that kind (they wanted a person of status—one gets status by doing things) would do that." This was a foreign idea to him. He said, "Oh my, if I want to talk about something in engineering, I want to be able to pick up my phone and call you. I don't want you to be off somewhere." We had a little discussion and at the end of the discussion, I said, "This means I shouldn't come. I must tell you that you don't understand that what makes a good engineering school is for the faculty to be involved in the

nation's problems. If you can't have that kind of a person as your head, you will always have a lesser status." So I told him thank you and I was sorry, but I should back out. And I did.

The other one was the University of Oklahoma, maybe a year later. I was very familiar with the place. I had lived in Oklahoma, 1933–1936; I had visited there and I knew the head of chemical engineering, and I had some former students there as well. I went there and I saw a challenge there. Our son was living in Tulsa at the time, but we tried not to let that be an influence on us. It was pretty hard for us to think of leaving Ann Arbor, as well. I found out that my wife, Maxine was having trouble sleeping, and said she just couldn't see going there to live. After a day or two, I called and said, "It is too disruptive at our age." It turned out that it was a wise decision. In a few months we learned that my wife had cancer, and it would have been a terrible thing for her to have had this bout with cancer over nearly a year, and to have been in a foreign town. I've never regretted that decision no to go. Those are the two that I investigated.

Sabbatical Leaves

I took two, maybe three significant sabbaticals. They didn't have them earlier, because of the war. My first sabbatical was in the spring of 1949. I took a semester off. I was doing some work in California, and we decided to go to Hawaii. We went to Hawaii for the first two weeks of March. It was a wonderful vacation, the first real vacation I had. I read a couple of books, one on astronomy. I read some books on religion. We stayed on Waikiki Beach, in a cabin where we could look out and see the coconuts on the tree outside our window. During this time I wrote some 13 papers.

The next sabbatical was in 1956–1957. I took a year off, staying in Ann Arbor, and I wrote the book that really established my international reputation. It was called *Handbook of Natural Gas Engineering*, initiated in 1953 with five former students and a close associate at the gas company, John Vary. We wrote this book, which turned out to be an 800-page 8½ in. × 11 in. book, and it sold internationally and is still selling now in its 28th year. It was translated into Russian in 1965. I was never able to get a copy of the Russian version, but I was able to get the loan of one. I didn't realize, I should have copied the whole book, but I copied the title page. The Russian people, when we went there in 1971, were very friendly and gave us a royalty on the book. Not too much, because they only sold the book for \$6.00, and we charged \$37.50 for it in the United States, in the early times. It's up to \$100 now. Nevertheless, it was a very important contribution.

During this second sabbatical, I had a separate room. Professor Williams was acting chairman of the department. It was a fine experience. I had been in the business 25 years, and I could really put this together. I had good students, and

they wrote parts of their chapters, and I finished them up. It was a good thing. For example, it's what made the people in Venezuela ask me to come, and I gave lectures there four times in the 1972–1974 period. I went to Iran and gave lectures at Abidjan in 1975 and 1978, always using this book as the basis for those lectures. They knew me because of the book. Even the people in China, in 1982 when we went there, they knew me because of the book. But it was the Russian version that they were using in China, because the Russians were helping them and the Russians brought them their books on natural gas engineering.

The third one was when Betty and I were married in 1966. I took a semester off and I started a new book called *Underground Storage of Fluids*. We went to Switzerland and I wrote the outline for the book while staying at Saas Fee, our favorite spot in Switzerland—you can look beyond your bed with your head on your pillow and see the glaciers up at the top of the tallest mountain in Switzerland.

Chapter 6

SOME FACULTY FROM THE 1920–1980 ERA

THIS chapter includes lists of our faculty for four representative years—1930, 1959, 1968, and 1980. The first of these appears in Table 7, which is taken from *Chemical Engineering 1930* (University of Michigan Official Publication, Vol. XXXI, No. 31, December 14, 1929). The chapter also includes individual biographies of several of the faculty of the period. Much additional biographical information appears in Chapter 2 and elsewhere in the book.

Table 7 Chemical Engineering Department Faculty, 1930

<i>Name</i>	<i>Degree(s)</i>	<i>Title</i>
Alfred Holmes White	A.B., B.S.	Professor, Chemical Engineering
Albert Easton White	A.B., Sc.D.	Professor, Metal. Engineering & Director, Dept. Engin. Research
Walter Lucius Badger	M.S.	Professor, Chemical Engineering
John Crowe Brier	M.S.	Professor, Chemical Engineering
Clair Upthegrove	B.Ch.E.	Assoc. Prof., Metal. Engineering
William Platt Wood	A.B., M.S.E.	Assoc. Prof., Metal. Engineering
Geo. Granger Brown	Ph.D., Ch.E.	Assoc. Prof. Chemical Engineering
Edwin Myron Baker	B.S.	Assoc. Prof. Chemical Engineering
Warren Lee McCabe	M.S.E., Ph.D.	Asst. Prof., Chemical Engineering
Elmore Shaw Pettyjohn	M.S.E.	Asst. Prof., Gas Engineering
Lars Thomassen	Ph.D.	Asst. Prof., Chemical Engineering
Donald William McCready	B.S.	Instructor, Chemical Engineering
Charles William Selheimer	M.S.	Instructor, Chemical Engineering
Eugene Hendricks Leslie	Ph.D.	Non-res. Lecturer, Chemical Engr.

Walter L. Badger (1886–1958)

Rentschler, Ann Arbor

Walter L. Badger

Walter Lucius Badger was born in Minneapolis in 1886. He graduated from the University of Minnesota with a B.A. in 1907, a B.S. in chemistry in 1908, and an M.S. in 1909. During 1908–1910 he was an instructor in general chemistry at the University of Minnesota except for a few months as a chemist with the Great Western Sugar Company. From 1910–1912 he was assistant chemist at the Bureau of Standards. In 1912 Badger came to the U–M as an instructor (his letter of interest is reproduced below), subsequently becoming an assistant professor in 1915 and a professor in 1918. His research interests were in crystallization, heat transfer, and evaporation. He was instrumental in bringing to the University of Michigan some large-scale equipment from the Swenson Evaporator Company of Chicago, which was first installed in an unoccupied old boiler house and eventually on a bigger scale in the East Engineering Building. The equipment included both horizontal and vertical Swenson evaporators, a Swenson/Walker continuous crystallizer, and much auxiliary plant.

By 1936, Badger was heavily involved in outside work—particularly for the Dow Chemical Company—and had only a half-time appointment in the department. He was notorious for his chastisement and rather sarcastic treatment of students who did not measure up to his standards. But if Badger demanded much from his students, he also seemed to demand as much—if not more—from himself. He resigned from the department in 1937 in order to devote more time to his own consulting firm, which flourished in Ann Arbor for many years.

Badger is remembered as a highly intelligent, capable man who sported a wide range of interests and abilities—including a wonderful collection of old books detailing the chemical processes of the Middle Ages, and a passion for singing Gilbert and Sullivan operettas.

According to Elaine Harden, a former assistant to deans in the College of Engineering: “If Badger found you could be intimidated, then you were no longer challenging, and no longer stimulating to him. But as long as you knew your ground, then he found you stimulating and he enjoyed an exchange with you.”

Badger was coauthor with other members of our faculty of two important early books on chemical engineering: W.L. Badger and E.M. Baker, *Inorganic Chemical Technology*, McGraw-Hill (1928), and W.L. Badger and W.L. McCabe, *Elements of Chemical Engineering*, first published by McGraw-Hill in 1931 with a second edition in 1936.

3311-Portland Ave
Ann Arbor, Mich
Aug 16, 1911

Dr. Alfred H. White,
University of Michigan

Dear Sir:-

I was delayed on my trip and only received your letter of Aug. 8 this morning. On looking over your catalog, I find that the courses in Chemical engineering sound very attractive, and I very much desire to be considered further for the position. Courses 1 and 2, 12, 13, and 14, I would be the most interested in, especially the latter two. I could add a very extensive course in Sugar manufacture, tho' the subject may not be important enough to warrant a separate course.

I rather inferred from the tone of your advertisement that the position was open this fall. If such is the case, I would be able to come any time in September. I return to Washington Sept 6; but if I should obtain the position I should like to know before then, if possible; for in that case I would not make the extra trip.

Hoping to hear from you soon, favorably, I remain,

Yours very truly,

W. L. Badger

Walter L. Badger's application for a position at the U-M, 1911.

ANNOUNCING A SERIES OF
PRACTICAL ARTICLES ON

Heat Transfer
AND
Crystallization

TO INCLUDE

- I—*The Basic principles of Heat Transfer.*
- II—*The Practical Application of these Principles.*
- III—*Evaporator Types*
- IV—*Circulation.*
- V—*The Effect of Scale, Viscosity, etc.*
- VI—*Evaporator Efficiency*
- VII—*Principles of Forced Circulation Evaporation.*
- VIII—*Application of Forced Circulation Evaporation.*
- IX—*Crystallization, Theory of*
- X—*Practice of Crystallization*

BY *Professor W. L. Badger*

OF THE DEPT. OF CHEMICAL ENGINEERING,
UNIVERSITY OF MICHIGAN, ANN ARBOR,
MICH., AND DIRECTOR OF RESEARCH FOR
SWENSON EVAPORATOR COMPANY,
(*Subsidiary of Whiting Corporation*),
HARVEY, ILLINOIS, (CHICAGO SUBURB)



Lectures given by Walter L. Badger in 1928.

The accompanying illustrations show Badger’s initial application for a faculty position in the department and also his research interests.

Prof. Katz related a story about Badger: “Before supersaturation was really understood, Badger was called on to visit a new sugar mill, where they were really having trouble getting the sugar to crystallize. They boiled it and boiled it, and it just sat there and it wouldn’t crystallize. Well, the company people opened a manhole, to where the sugar was kept, so that Badger could dip out some of the solution. They stood there talking for awhile, turned around, and by gosh, the whole evaporator had solidified. So they puzzled and scratched their heads for a long time. Finally, they decided that the man who had come in from the other sugar mill had enough little, fine particles of sugar on his jacket to float into the vat and cause the solution to solidify!”

The original Badger Trophy was given—not for the doctoral student’s neatest apparatus, but to the one that was the most Rube Goldberg-like.† When Badger left the department (he never left Ann Arbor) he formed the Consulting Engineering Division of Dow Chemical, with offices on State Street. They did much work during World War II, including caustic/chlorine plant expansions, and the country’s only plant for recovery of manganese.

The Consulting Engineering Division lasted until 1946, when Badger split off from Dow, but shared offices with the renamed Ann Arbor Laboratory of Dow for three or four years, when Ferris Standiford started with him, joined also by Tenho Hindert, one of the U–M’s first woman chemical engineering graduates. Other employees in subsequent years were Julius Banchemo, Joe Martin, and Jim Sinek. Banchemo, working with G.G. Brown, received his U–M Ph.D. for his dissertation *Thermal Decomposition of Phenyl Ether*, and was a member of our faculty until he left in 1959 to become chairman of the Chemical Engineering Department at Notre Dame University.

Badger was ill in 1957, when the organization was incorporated as W.L. Badger Associates Inc., and died the following year. One of Badger’s former students, Harold Bjork, was brought in to manage things after his death, but when Harold died in 1970 the company was run “solo” by Ferris Standiford and still exists in Bellevue, Washington.



† We are indebted to Ferris Standiford for this and the subsequent information in this sketch of W.L. Badger.

Eugene H. Leslie (1892–1976)†

Eugene Hendricks Leslie was on the U–M chemical engineering faculty from 1919–1928. He was a pioneer in fractional distillation, the production of toluene and synthetic rubber, and the recovery of tungsten carbide from tungsten scrap.



Courtesy Leslie Science Center, Ann Arbor Parks and Recreation

Eugene H. Leslie and Emily Leslie.

Born in 1892, he received his bachelor's degree from the University of Illinois in 1913 and his Ph.D. from Columbia University in 1916, both in chemical engineering. His doctoral dissertation was titled *The Decomposition of Hydrocarbons and the Influence of Hydrogen in Carbureted Water-Gas Manufacture*. Leslie's first position was as chief chemist at the General Petroleum Corporation in Los Angeles. He was a pioneer in the production of toluene (from which TNT is made) by the fractionation of petroleum—a project of national importance because supplies from Germany ceased during World War I. He subsequently took another position with the U.S. Industrial Alcohol Company in New York City, to work on the production of synthetic acetone.

† Based on information contained in two articles from *The Ann Arbor News*: “Remembering Eugene H. Leslie,” by Suzanne Fleming, 27 August 1992, and “Oil Industry Pioneer Isn’t Slowing Up,” by Larry Bush, 5 September 1971. Reprinted with permission of the *Ann Arbor News*, 2002—all rights reserved. We also gratefully acknowledge input from Cheryl Saam and Kirsten Levinsohn of the Leslie Science Center.

Leslie was appointed an associate professor of chemical engineering at the University of Michigan in 1919 and became a professor in 1923. He played a very important role in the initial development of the doctoral program in the department, and G.G. Brown (1924 dissertation title: *The Rate of Pressure Rise in Gaseous Explosions*) was one of his first three doctoral students.

An independent type himself, Leslie fostered independence in his students. G.G. Brown clearly took inspiration from Leslie's freedom-loving ways. Donald Katz said: "Leslie brought Brown the idea that inspired his doctoral research, and Brown ran with it. The subject—the rate of rise of pressure in a gaseous explosion, such as in an automobile engine—was an entirely new kind of thought. Brown built the equipment and ran it himself, and published the paper under his own name. It was Leslie who had motivated Brown into being an independent person."

Table 8 From Lavoisier to Leslie and Others†

<i>Name</i>	<i>Dates</i>	<i>Degree</i>	<i>Comments</i>
Antoine Lavoisier	1743–1794	Paris 1763	
Antoine Francers, Comte de Fourcroy	1755–1809	Paris 1780	Student of Lavoisier; Prof., Paris 1784–1809
Louis Vauquelin	1763–1829	Paris 1785	Asst. to Fourcroy Prof., Ecole Polytech- nique, 1811-1829
Friedrich Struh- meyer	1776–1835	Göttingen 1800	Asst. to Vauquelin. Prof., Göttingen, 1802–1835
Robert Bunsen	1811-1899	Göttingen 1830	Prof., 1836–1886, Cassel, Marburg, Breslau, Heidelberg
Siegmund Gabriel	1851–1924	Heidelberg 1874	Professor at Berlin
Franz Sachs		Berlin 1898	Professor at Berlin
Milton Whitaker		Berlin 1902	Professor at Columbia
Eugene Leslie	1892–1976	Columbia 1915	Prof., Univ. Michigan
George G. Brown	1896–1957	Michigan 1924	Prof., Univ. Michigan
Brymer Williams	1913–	Michigan 1949	Prof., Univ. Michigan
Peter Lederman	1931–	Michigan 1961	Prof., NJ Inst. Tech.

† Main source: *One Hundred Years of Chemical Engineering*, pages 35 and 36, ed. Nikolaos A. Peppas, Kluwer Academic Publishers, London, 1989.

After two years at Michigan, Leslie became convinced that fractionation with bubble-cap or packed columns was the most efficient way of refining petroleum into its fractions. He published a related book, *Motor Fuels*, in 1923, which led the E.B. Badger and Son's Co. of Boston, a manufacturer of distillation equipment, to provide the funds for building a significant laboratory of pilot-scale fractionation equipment in Ann Arbor. Shortly afterwards, fractionating plants became widespread in the petroleum industry.

After leaving the U–M in 1928 to enter private practice, Leslie largely worked as a consultant to the oil industry, conducting many experiments in the “Leslie Laboratories” at his home, 1831 Traver Road in Ann Arbor. During World War II, when supplies of raw rubber were stopped by the Japanese, Leslie collaborated with the Blaw-Knox Company and again became a pioneer—this time in the development of synthetic rubber from butadiene.

Subsequent ventures, which did not find broad commercial endorsements, included hot-air drying of grain and hay, improving the quality of gravel by removing the softer stones, and a method for improving the survival rate of new-born piglets.

The Leslies enjoyed having the neighborhood children play on their homestead property. Spontaneous softball games, kite-flying, and hide-and-seek were popular activities. The youngsters also built tree forts in the hedgerows and helped collect fruit in the orchards. Dr. and Mrs. Leslie decided that their land, which they had shared freely with their neighbors, should be given to the City of Ann Arbor to be maintained as a place where children could play. Dr. Leslie, who died in 1976, expressed the hope that their property would be preserved as “an open space for all time.” The Leslie Science Center, administered through the City of Ann Arbor Parks & Recreation Department, now provides natural-science and environmental-education opportunities for youths and their families. The Leslie Center is situated on 50 acres of fields, woods, and prairie at the Leslie home.

Through generations of teachers and students shown in Table 8, the academic lineage from Lavoisier, the father of modern chemistry, flows to E.H. Leslie, University of Michigan professor, and thence to subsequent generations at Michigan. The dates are those of the highest degrees obtained. Leslie subsequently influenced not only G.G. Brown but other notable U–M scholars such as Warren McCabe.

Edwin M. Baker (1893–1943)

Chemical Engineering Faculty Man Had Been Here Since 1918.† Professor Edwin M. Baker, of the University of Michigan Chemical Engineering Department and a member of the faculty since 1918, died yesterday afternoon in the Hotel Biltmore in New York City from heart trouble, with which he was stricken May 14 while there on war business. Professor Baker, who was 50 years old, had been

† From an article, “Professor E.M. Baker Dies in New York of Heart Trouble,” *Ann Arbor News*, Thursday, May 27, 1943. Reprinted with permission of the *Ann Arbor News*, 2002—all rights reserved.

in apparent good health when he went to New York early in May as consulting engineer for the Houdaille Hershey Co. His wife, Ruth, went to New York to be with him after he was taken ill. Well-known in the chemical engineering field, particularly for research in electro-plating, Professor Baker had been associated with the Houdaille Hershey Co. since 1919 and with the C & G Spring & Bumper Co. for several years. He was president of the American Electrochemical Society in 1942–1943.

Came Here in 1918. Professor Baker joined the Michigan faculty as an instructor in 1918, was advanced to assistant professor in 1920, to associate professor in 1929, and to professor in 1933. He had published 50 research and technical articles in professional journals. He was coauthor of an early book on chemical engineering: W.L. Badger and E.M. Baker, *Inorganic Chemical Technology*, McGraw-Hill (1928).

In the second semester of 1937–1938, Prof. Baker was acting chairman of the Chemical and Metallurgical Engineering Department. Since 1938, he had been chairman of the committee of the Engineering College on coordination of teaching. From 1940 to this year he was on the Senate Advisory Committee. Born in Toledo, February 21, 1893, a son of Myron Daniel and Caroline Asenath Maples Baker, Prof. Baker received his education in township schools in New York state, at Hyattsville, MD, and at Washington, DC, graduating from McKinley High School in the capital in 1912. In 1916 he received a degree of Bachelor of Science from Pennsylvania State College.



Rentschler, Ann Arbor

Edwin M. Baker

the chemical fraternity, Alpha Chi Sigma. He also was a member of the Research Club on the campus and the U–M Club of Ann Arbor.

Besides his wife, Prof. Baker leaves three sisters, Mrs. Maude A. Beye, Litch-

At Niagara Falls. After graduating from Penn State, Prof. Baker worked for two years for the Hooker Electrochemical Company in Niagara Falls, NY. On June 14, 1920, he was married to Ruth Lewis of Tonawanda, NY. They lived here at 1603 Morton Avenue. Professor Baker was a member of the American Institute of Chemical Engineers, the American Electroplaters Society, the American Society for Testing Materials, the Society for the Promotion of Engineering Education, the American Association of University Professors, the American Chemical Society, and the American Electrochemical Society. He also belonged to several honorary societies, including Tau Beta Pi, Phi Kappa Phi, Sigma Xi, Phi Lambda Upsilon and Iota Alpha. Since 1934 he had been financial adviser to the

field, CT; and Mrs. Edith M. Gray and Mrs. Florence A. Lincoln, Silver Springs, MD. Prof. Baker's body is being brought back to Ann Arbor today and can be viewed by friends at the Dolph funeral home tomorrow and Saturday. Funeral services will be held Saturday afternoon, with burial in Washtenong Memorial Cemetery.



Courtesy Judson Brown

Prof. Brier's office—a worthy candidate for the “Pooh-Bah of the Piled Papers” award.

John Crowe Brier (1889–1976)



Rentschler, Ann Arbor

John C. Brier

John Crowe Brier, born in Yorkshire, England, 27 February, 1889, closed a productive life just short of his 87th birthday. He received his bachelor's and master's degrees in chemical engineering from the University of Michigan in 1912 and 1913. Brier returned to the university, briefly, as an assistant professor in 1918, the year he became a citizen of the United States. He returned again as professor of chemical engineering in 1921, remaining in that position until his retirement in 1959. He was one of the four “B's”: (W.L.) Badger, (E.M.) Baker, (J.C.) Brier, and (G.G.) Brown, who, with others under the leadership of A.H. White, raised chemical engineering at Michigan to a position of international recognition. On leave from the university during World War II, Colonel Brier was commanding officer of the Southwestern Proving Ground and was awarded the Legion of Merit for his service.

ing officer of the Southwestern Proving Ground and was awarded the Legion of Merit for his service.

In his research, Professor Brier recognized earlier than most the value of renewable natural resources as raw materials for the chemical industry, and he made substantial contributions in the science of burning solids and the technology of explosives. He had the ability to form strong, enduring friendships with his students in the classroom or laboratory and in his recreation—fishing, water polo, and duplicate bridge. He kept these relationships with students into retirement, as long as he was physically able. Students, in turn, recognized his unique filing and information retrieval system with an annual award (“Pooh-Bah of the Piled Papers”), which persisted for more than four decades.

There are many students throughout these generations who could not have finished academic work without his encouragement and support. Among these are two of his doctoral students who typify his spirit: Stuart W. Churchill, Carl V.S. Patterson Professor of Chemical Engineering at the University of Pennsylvania, and Charles M. Thatcher, Alcoa Professor of Chemical Engineering at the University of Arkansas.

Colorful, competent, and crusty in a lovable way, “Cactus Jack” Brier gave himself generously to colleagues and students, who are grateful for having known and worked with him.

“To live in the hearts we leave behind, is not to die.”

Warren L. McCabe (1899–1982)



Rentschler, Ann Arbor

Warren L. McCabe

Before completing his Ph.D. in chemical engineering at the U–M, Warren McCabe spent some time at the Massachusetts Institute of Technology, working with Prof. Thiele on what was to become the famous “McCabe/Thiele diagram” for a graphical interpretation of binary distillation calculations. After completing his Ph.D. in 1928 (dissertation title: *Crystal Growth in Aqueous Solutions*), he became a member of our faculty. He collaborated with W.L. Badger in writing their landmark book, *Elements of Chemical Engineering*, first published by McGraw-Hill in 1931, with a second edition in 1936. McCabe served on our faculty until 1937, when he joined the Carnegie Institute of Technology. After a period in industry with the Flintkote Corporation in New York, he returned successively to three more academic positions, at the Polytechnic Institute of Brooklyn, Cornell University, and finally “retiring” to North Carolina State University.

William Platt Wood (1888–1954)

Was Professor of Metallurgy Here for the Past 36 Years.† Prof. William Platt Wood, 66, researcher in the field of steel and cast iron, and an outstanding teacher of metallurgical engineering at the University of Michigan for 36 years, died suddenly at his office yesterday afternoon. Death was caused by a heart attack. An expert on the use and treatment of steel in springs, Prof. Wood also was an early contributor to the studies of the isothermal transformation of austenite in cast irons, a factor in the development of alloy irons with superior mechanical properties. In 1927 he was co-author of a book on pyrometry with Prof. J.M. Cork of the Physics Department and recently was a contributor to a treatise *Unit Operations* by Dean George G. Brown of the College of Engineering and his associates. Prof. Wood served as a consulting metallurgical engineer to numerous companies.



Rentschler, Ann Arbor

William P. Wood

Born in Ypsilanti. He was born in Ypsilanti on May 26, 1888, the son of Maurice G. and Margaret Platt Wood. He received a bachelor of pedagogy degree from Michigan State Normal College in 1909. After teaching science and mathematics at Stafford High School in Kansas he came to the University of Michigan and received his bachelor's degree in chemical engineering in 1914. For three years thereafter he was assistant professor of chemistry at Michigan State College. During this period he completed work for his master's degree at the U-M. He started teaching at the U-M as assistant professor in 1917 but was called to Detroit as supervisor of materials for the U.S. Bureau of Aircraft Construction early in 1918. When the war ended, he returned to the university and had served

continuously since that time. In 1931, he was promoted to full professor of metallurgical engineering, the position he held at his death. Prof. Wood was a member of Alpha Chi Sigma, Theta Xi, Phi Lambda Upsilon, Sigma Xi, and the Research Club of the university. His memberships in metallurgical societies included the American Society of Metals and the American Foundrymen's Society.

Was Exchange Member. He was a member of the Exchange Club and the First Presbyterian Church. His home was at 2029 Vinewood Blvd. In speaking of Prof. Wood's contribution to the U-M, Prof. Donald L. Katz, chairman of the Chemical and Metallurgical Engineering Department, stated that Prof. Wood was a patient teacher and possessed the faculty of making difficult subjects appear simple.

† From an article, "W.P. Wood, U-M Engineer, Passes at 66," *Ann Arbor News*, 13 July 1954. Reprinted with permission of the *Ann Arbor News*, 2002—all rights reserved.

In 1917, he married Antoinette Willey, who survives him. A son, William M. Wood; a daughter, Mrs. Robert J. Parker; and four grandchildren, all of Ann Arbor, also survive. Funeral services will be held at 3 PM Thursday at the Muehlig Chapel with Dr. William P. Lemon and Rev. Henry Kuizenga officiating. Burial will be held in Forest Hill Cemetery. Friends may call at the funeral home until Thursday noon.

Lloyd Earl Brownell (1915–1976)

Professor Brownell was born on November 8, 1915, in Potsdam, New York, and received his bachelor of chemical engineering degree in 1937 from Clarkson College and a master of mechanical engineering from that school in 1939. He received a master of science degree and a doctorate in chemical engineering from the University of Michigan in 1942 and 1947, respectively. He joined the University of Michigan faculty in 1947 as assistant professor, was promoted to associate professor in 1950, and to professor in 1954. He was named Professor Emeritus of Chemical, Metallurgical, and Nuclear Engineering on December 19, 1975. He became supervisor of the Fission Products Laboratory in 1951, and took part in the first United Nations meeting on the peaceful uses of atomic energy in Geneva, Switzerland, in 1955.

He actually came to Michigan via a small bakery-equipment manufacturer. The company was interested in achieving a glaze-like appearance on freshly baked bread without the use of butter, and had asked the Chemical Engineering Department to research the problem. A small-scale bakery was built, and Brownell was sent down to oversee the operations.

At Michigan, Brownell studied the flow of fluids through porous media and continued his interest in food technology, including the effect of radiation on food and drug sterilization. In 1954, he initiated research activities in the general utilization of gross fission products for the preservation of foods and earned an international reputation in the field of food technology or bioengineering. Simultaneously, he established a reputation in the design of chemical process equipment and co-authored (with Edwin Young) a standard reference text, *Process Equipment Design*, published by John Wiley & Sons in 1959. He introduced the first modern approach to flow through porous media. About the same time, he expanded his research activities into the study of interior ballistics.

Brownell and Giza Gjorey of the Nuclear Engineering Department were the first people ever to measure the velocity inside a rifle, and this was genuinely new and exciting research on ballistic speed and pressure. Of course, Brownell did scare people in the East Engineering Building on the occasions he would come in to load up his shells with black powder. For a while his “firing range” was in the Phoenix Building in the nuclear engineering laboratory. His research was legitimate and approved, but one particular day he pulled the trigger at the same time that a

staff member was walking through the door with highly contaminated glasswork. He was eased out of the Phoenix Building and transferred over to the basement of the G.G. Brown Building.



U-M Chem/Met graduate booklet, Nov. 1957

Profs. Lloyd E. Brownell & Wayne W. Meinke check the gamma-radiation field from a cobalt-60 source during their studies on the effect of radiation on foods.

Brownell had a long-term consulting arrangement with Battelle Northwest and its successor, the Atlantic Richfield Hanford Company, where he was employed at the time of his death, involving research experiments of national importance. He was also a visiting professor at the College of Petroleum and Minerals at Dhahran, Saudi Arabia.

“He was an ingenious inventor and idea generator,” recalls a former colleague. “In the course of an afternoon, he could come up with a dozen different suggestions for solving a problem.” His innate capability of rapidly generating original ideas, plus his investigative capability as a researcher, enabled him to develop his ideas effectively. As a highly successful experimentalist, he brought recognition to the university.

Professor Brownell and the former Janet Doris Emmons were married in Potsdam, New York, in 1938. They had five children: Gary Gene, Stephen Bruce, John Charles, Pamela Sue, and Carol Cam, and four grandchildren. Prof. Brownell died of a stroke in Richland, Washington, on February 8, 1976.

Cedomir M. Sliepcevich

We are indebted to our former U–M faculty colleague, Cedomir (“Cheddy”) Sliepcevich, for making substantial contributions to this history book.

Born in 1920 in Anaconda, Montana, he received his early education at Anaconda High School (from 1933 to 1937) and Montana State College in Bozeman (1937–1939). In 1939 he transferred to the U–M, from which he received all of his degrees: B.S. (1941), M.S. (1942), and Ph.D. (1948), all in chemical engineering. For his doctorate, working with G.G. Brown, he established procedures for conducting chemical reactions at temperatures up to 1000 °F and pressures up to 10,000 psi, leading to his dissertation *The Design, Construction, and Operation of a High Temperature, High Pressure Plant*. From 1942–1948, while pursuing his doctoral studies, Cheddy served as a private consultant on a variety of problems related to the development of the atomic bomb, the proximity fuse, and sampling for two-phase flow from high-pressure natural gas wells. In addition, he was employed by the U–M Research Institute on a number of classified projects.



Cedomir M. Sliepcevich

During his graduate studies, Cheddy was a research assistant or teaching fellow continuously, until his appointment to our faculty as an instructor in 1946. He collaborated with G.G. Brown on the teaching of thermodynamics and became one of the department’s best teachers, particularly in that field†. He gave the first seminars offered by our department on the kinetics of chemical reactions. (A formally approved course came later.) Although his primary responsibility was the graduate course in thermodynamics, he taught at one time or another most of the other undergraduate and graduate courses. He also served as chairman of the department’s graduate committee. Cheddy was an assistant professor from 1948–1951, and an associate professor from 1951–1955—except when he took a leave of absence from Michigan during 1952–1953 to work as a senior chemical engineer at the Monsanto Chemical Co. in East St. Louis.

Cheddy’s research has been in an unusually large number of areas, including energy scattering, high-pressure reaction kinetics, flame dynamics, heat and mass transfer, system identification and control, natural-gas technology, cryogenics, thermodynamics, viscoelasticity, extractive and powder metallurgy, desalination, energy conversion, and bioengineering. His research on small particles, their

† See page 71 et seq.

formation by atomization, and the principles of light scattering when these particles are dispersed in fluids, is summarized on page 323. Collaboration with the U-M Medical School led to research into two areas: streaming-potential phenomena in blood circulation and diffusion through membranes related to artificial kidneys. He was also the first member of our faculty to utilize high-speed electronic computation in academic research.

Cheddy's most significant contribution to industry was his pioneering contributions to the development of the liquefied natural gas industry. In 1956 he was retained by the Constock Liquid Methane Corporation to manage all of their research, development, and engineering, from the laboratory to the first commercial venture. There, he had a "hands-on" involvement in the development of liquefaction cycles, special materials for cryogenic service, marine tankers, storage tanks, revaporization facilities, and safety and fire-protection standards.

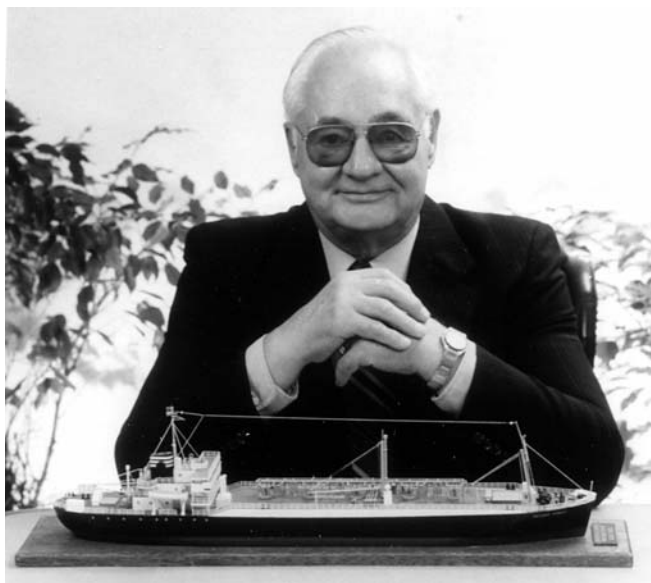

Cedomir ("Cheddy") Sliepcevic with a scale model of the world's first marine LNG (liquefied natural gas) tanker. Photo taken ca. 1988.

Professor Sliepcevic left the department in 1955 to assume the chairmanship of the Department of Chemical Engineering at the University of Oklahoma, where he also served as associate dean of the College of Engineering from 1956–1962. In 1963, he relinquished all administrative responsibilities to devote full time to teaching and research as the George Lynn Cross Research Professor of Engineering. In 1992 he was honored at Oklahoma by the establishment of the C.M. Sliepcevic Professorship in Chemical Engineering. Cheddy has received numerous awards, including our own D.L. Katz Lectureship in 1976.

Julius T. Banchemo (1914–1997)*Julius T. Banchemo*

Julius T. Banchemo (“Banky” to almost everyone) was born in New York City, the only son of an Italian family, and received his early education from 1925–1929 at All Hallows Institute in New York City. His first three degrees were from Columbia University: A.B., 1933; B.S. (chemistry), 1935; and Ch.E., 1936. During 1936–1938 he worked for the Carbide and Chemicals Corporation in Charleston, West Virginia, and from 1938–1941 he was an instructor in chemical engineering at the University of Detroit. Banchemo then came to the University of Michigan to pursue doctoral work with G.G. Brown, and received his Ph.D. in 1950 for his dissertation *Thermal Decomposition of Phenyl Ether*. He was first appointed as an instructor in our department in 1943 and taught extensively during his time as a doctoral student.

*David Malcolm Brown and Julius T. Banchemo.*

Subsequent promotions were to assistant professor (1949), associate professor (1955), and professor (1957). He specialized in unit operations and process design, and was a consultant to the Dow Chemical Company, the W.L. Badger Company (Ann Arbor), and to the Union Carbide and Chemicals Corporation. He wrote chapters on solid/liquid and liquid/liquid extraction in Brown’s *Unit Operations*.

He was also coauthor with W.L. Badger of *Introduction to Chemical Engineering* (McGraw-Hill, New York, 1955). Our students appreciated “Banky” for his enthusiastic and excellent classroom teaching. Representative courses taught by him (in 1958/1959) were *Unit Operations II* (CM 115), *Design of Process Equipment* (CM 121), *Chemical Process Design* (CM 130), *Special Research and Design* (CM 210), and *Equilibrium Stage Operations* (CM 212). He left Michigan in 1959 to become chairman of the Department of Chemical Engineering at Notre Dame University.

Robert R. White

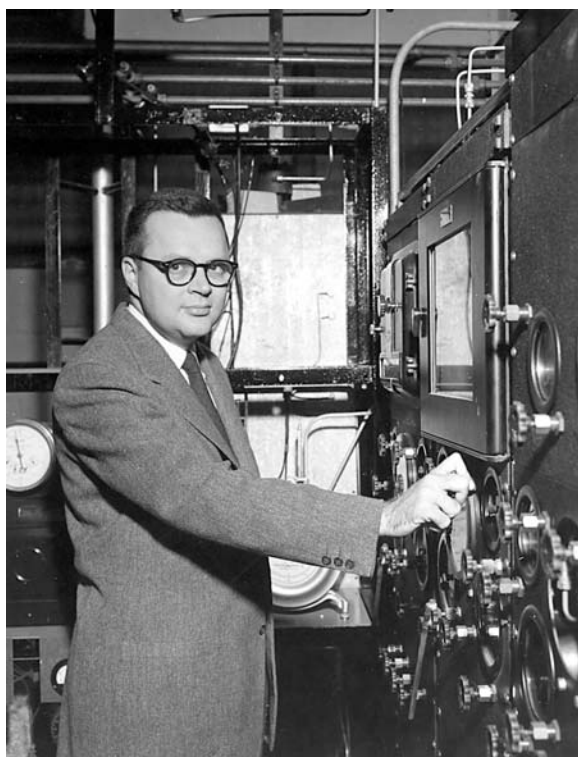

Robert Roy White.

Robert (“Bob”) Roy White, P.E., born in Brooklyn in 1916, received his early education in Wilmette, Illinois and then in Port Jefferson, New York. He subsequently received three chemical engineering degrees—B.S. (Cooper Union Institute, 1936), M.S. (U–M, 1938) and Ph.D. (U–M, 1940). In 1940 he was employed by the Standard Oil Company of California as a research engineer and was engaged in technical service to the El Segundo Refinery. In late 1940 he accepted a position with Universal Oil Products Company in Chicago, where he was concerned with the technical aspects of their legal activities. He was appointed an instructor of

chemical engineering at the U–M in 1942, rising through the ranks to professor in 1948. He won the U–M’s prestigious Henry Russell Award (for instructors or assistant professors) in 1946 for “conspicuous service.”

At the U–M, Bob White’s research activities and publications centered on phase equilibria, mass transfer, reaction kinetics, mixing in packed beds, and fractional and azeotropic distillation, which led to some 60 publications in these areas and also that of engineering education. He was also a significant contributor to G.G. Brown’s *Unit Operations*. He received the AIChE Professional Progress Award in 1956. He chaired the committee that set up the nuclear engineering program at the U–M.

In 1958 White was appointed associate dean of both the U–M Horace Rackham School of Graduate Studies and of the College of Engineering. In the latter position, his duties pertained to problems of degrees and curricula, changing patterns of educational needs, and the relation of research to education.

In 1959 White became the first director of the U–M’s new Institute of Science and Technology, for which the first year’s budget was \$500,000 from the U–M and an equal amount from the State of Michigan. Two early initiatives of the Institute were space science and technology and Great Lakes research. He left the U–M in 1960 to accept the position of vice-president and manager of research and development with the Atlantic Refining Company in Philadelphia. Subsequent positions included (amongst others) appointment as vice-president for development at Champion Paper Co., president of the Research Division of W.R. Grace & Co. (1966), and dean of the School of Management at Case University (1967).

J. Louis York

A biographical sketch and photograph of Prof. York appears on page 550, since he was the 1994 recipient of the Chemical Engineering Alumni Society Merit Award.

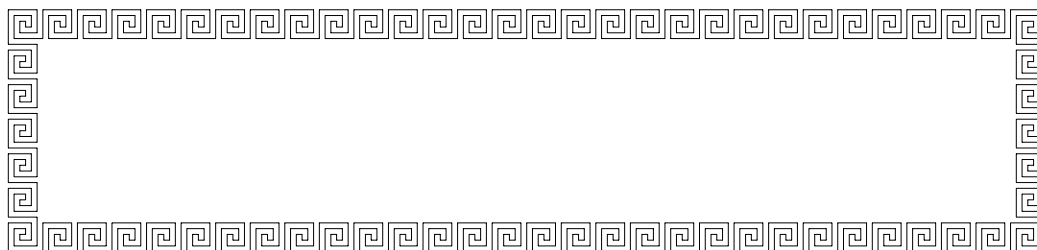

The photograph on the next page (courtesy Madge Ingerson and Sandra Coryell) is of the faculty on one of their “off” days in 1959. They are restored to full dignity one page later.

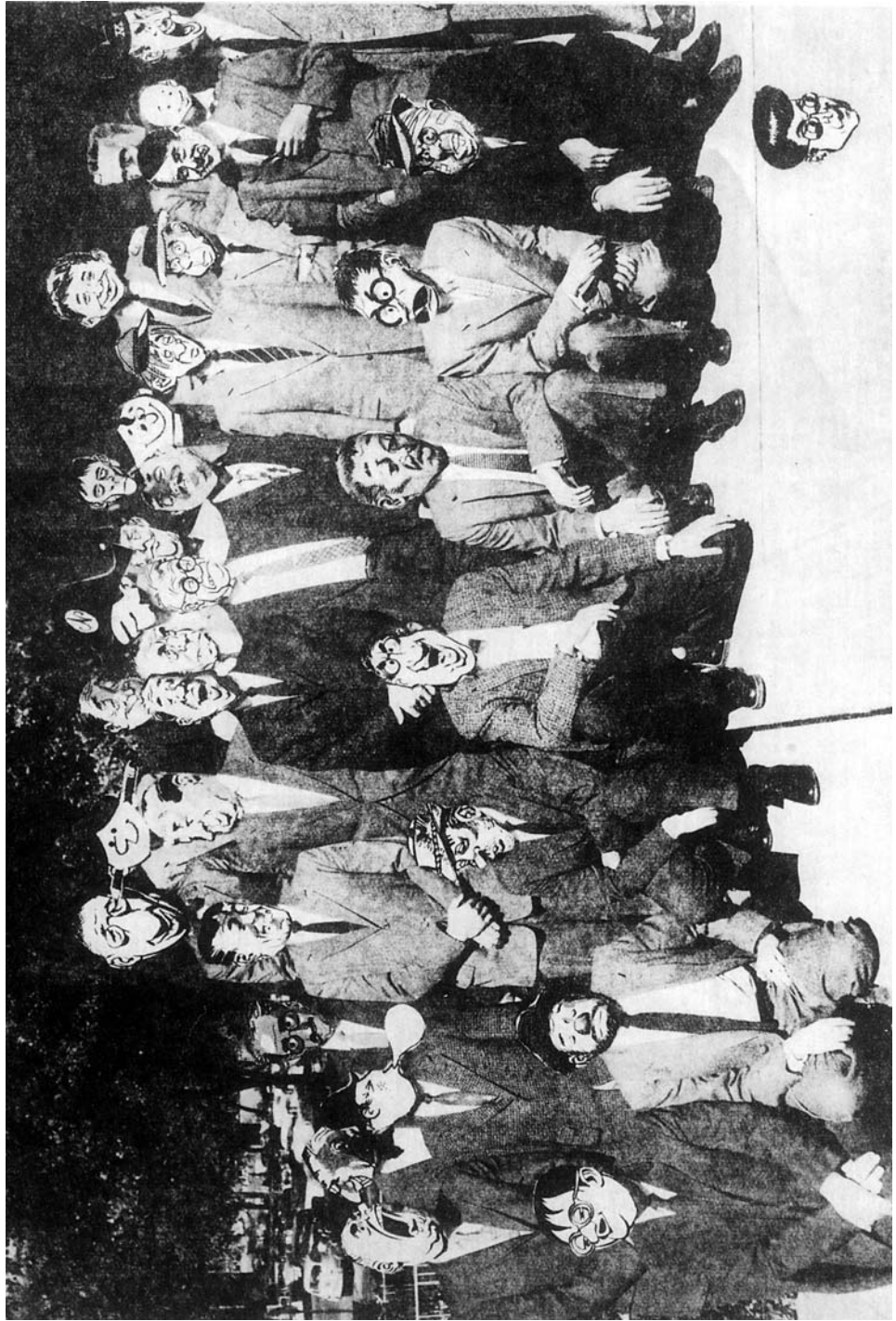

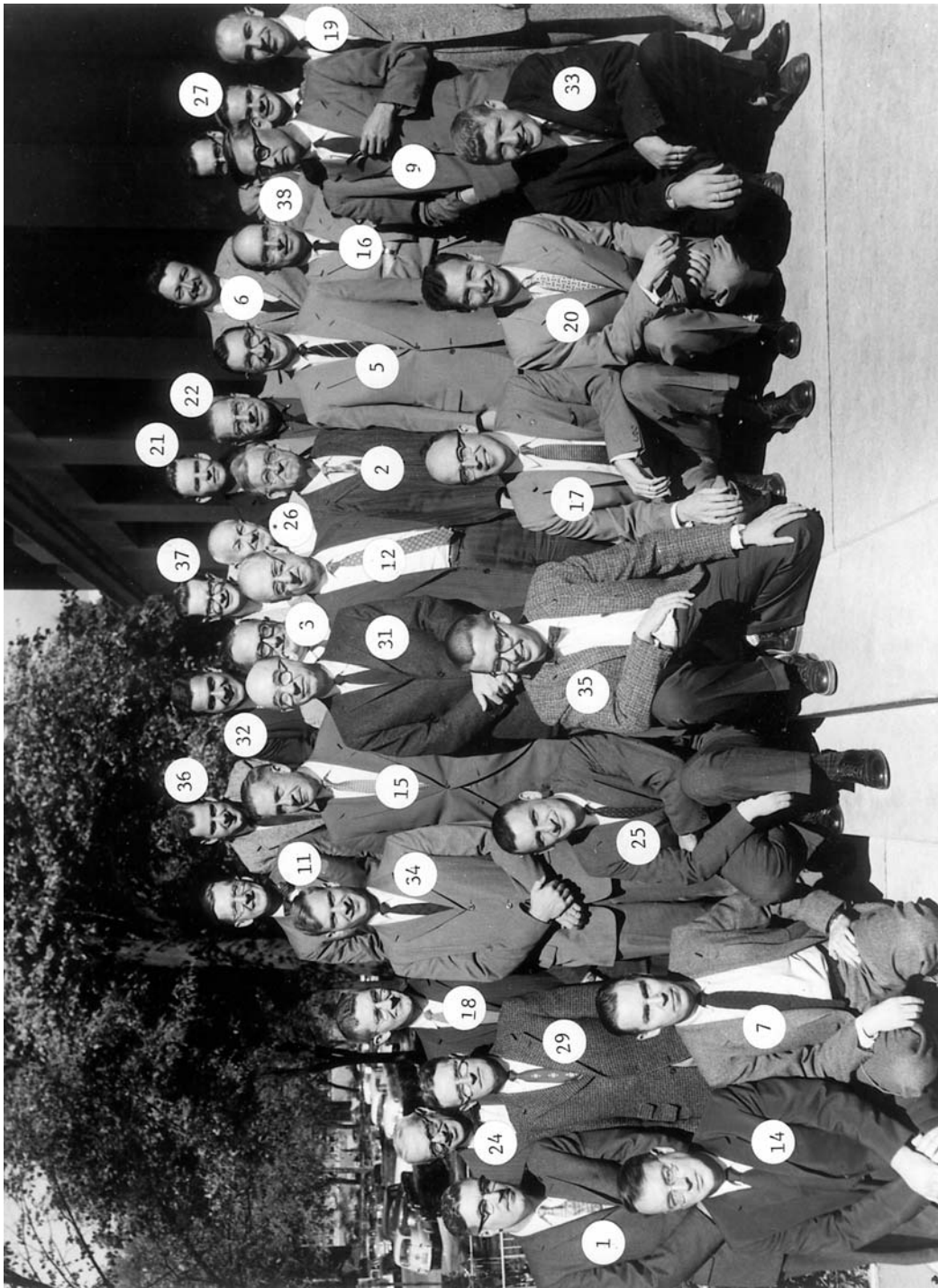

Table 9 Faculty, 1959–1960, in the 1959 Photograph (Facing Page)

	<i>Name</i>	<i>Degree</i>	<i>Title</i>
1.	Donald L. Katz	Ph.D.	Prof. of Chem. Engr. & Chairman, Chem. & Met. Engr.
2.	John Crowe Brier	M.S.	Prof. Emeritus of Chem. Engr.
3.	Lloyd E. Brownell	Ph.D.	Prof. of Chem. Engr.
4.	Leo L. Carrick	Ph.D.	Prof. Emeritus of Chem. Engr.
5.	Stuart W. Churchill	Ph.D.	Prof. of Chem. Engr.
6.	Richard A. Flinn	Sc.D.	Prof. of Met. Engr.
7.	Lloyd L. Kempe	Ph.D.	Prof. of Chem. Engr. & Bacteriology
8.	Joseph J. Martin	D.Sc.	Prof. of Chem. and Met. Engr.
9.	Richard Schneidewind	Ph.D.	Prof. of Met. Engr.
10.	Clarence A. Seibert	Ph.D.	Prof. of Chem. and Met. Engr.
11.	Maurice J. Sinnott	Ph.D.	Prof. of Chem. and Met. Engr.
12.	Lars Thomassen	Ph.D.	Prof. of Chem. and Met. Engr.
13.	Robert R. White	Ph.D.	Prof. of Chem. and Met. Engr. & Dir., Inst. of Science and Technology
14.	G. Brymer Williams	Ph.D.	Prof. of Chem. Engr.
15.	James W. Freeman	Ph.D.	Prof. of Chem. and Met. Engr. & Res. Engr., U–M Research Institute
16.	J. Louis York	Ph.D.	Prof. of Chem. and Met. Engr.
17.	Edwin H. Young	M.S.E.	Prof. of Chem. and Met. Engr.
18.	Lawrence H. Van Vlack	Ph.D.	Prof. of Materials Engr.
19.	Wilbur C. Bigelow	Ph.D.	Assoc. Prof. of Chem. and Met. Engr.
20.	Kenneth F. Gordon	Sc.D.	Assoc. Prof. of Chem. Engr.
21.	Edward E. Hucke	Sc.D.	Assoc. Prof. of Met. Engr.
22.	Donald W. McCready	Ph.D.	Assoc. Prof. of Chem. Engr.
23.	Donald R. Mason	Ph.D.	Assoc. Prof. of Chem. Engr.
24.	Giuseppe Parravano	Ph.D.	Assoc. Prof. of Chem. and Met. Engr.
25.	David V. Ragone	Sc.D.	Assoc. Prof. of Met. Engr.
26.	Richard E. Townsend	M.S.E.	Assoc. Prof. of Chem. and Met. Engr.
27.	Keith H. Coats	Ph.D.	Asst. Prof. of Chem. Engr.
28.	Robert D. Pehlke	Sc.D.	Asst. Prof. of Met. Engr.
29.	Walter B. Pierce		Asst. Prof. of Foundry Practice
30.	Dale F. Rudd	Ph.D.	Asst. Prof. of Chem. Engr.
31.	William A. Spindler	M.S.	Asst. Prof. of Met. Engr.
32.	M. Rasin Tek	Ph.D.	Asst. Prof. of Chem. Engr.
33.	Richard E. Balzhiser	M.S.E.	Inst. of Chem. Engr.
34.	James A. Ford	Ph.D.	Inst. of Met. Engr.
35.	Richard A. Hummel	B.S.	Inst. of Chem. Engr.
36.	Peter B. Lederman	M.S.E.	Inst. of Chem. Engr.
37.	Robert L. Norman	M.S.E.	Inst. of Chem. Engr.
38.	Paul K. Trojan	M.S.E.	Inst. of Met. Engr.

Profs. Carrick, Mason, Siebert, and White were absent when the picture was taken. Drs. Rudd and Pehlke were to join the staff in February 1960. Prof. Martin was on leave.



Faculty in the 1968 Photograph on the Facing Page†

Back row: Edward E. Hucke, Rane L. Curl^c, William F. Hosford, Jr., James O. Wilkes^c, Dale E. Briggs^c, James W. Freeman, Joseph J. Martin^c, and G. Brymer Williams^c.

Center row: Joe D. Goddard^c, J. Louis York^c, Jerome S. Schultz^c, H. Scott Fogler^c, Gregory S-Y. Yeh^c, Francis M. Donahue^c, Richard E. Balzhiser^c, Donald L. Katz^c, Lawrence H. Van Vlack (chairman), Lloyd L. Kempe^c, Orville F. Kimball, Wilbur C. Bigelow, Robert H. Kadlec^c, M. Rasin Tek^c, and Clarence A. Siebert.

Front row: Robert E. Barry^c, Robert D. Pehlke, John E. Powers^c, and Brice Carnahan^c.

†In 1968, our name was the Department of Chemical and Metallurgical Engineering. A superscript “c” denotes those faculty whose primary interest is in chemical engineering. Those not so designated form the metallurgical/materials engineering part of the department. Faculty not present in the photograph were: Lloyd E. Brownell^c, Richard A. Flinn, J. Donald Hanawalt, Giuseppe Parravano^c, Maurice J. Sinnott^c, Tseng-Ying Tien, and Edwin H. Young^c.

Giuseppe Parravano (1917–1978)‡

Giuseppe Parravano was born in 1917 in Florence, Italy and was the son of Nicola Parravano, a distinguished physical chemist. Giuseppe received his early schooling in Rome and attended the University of Rome. He received his first doctorate in 1940 in electrical engineering and a second doctorate in 1941 in chemistry. Even though these were difficult times, he immediately began to do research. His first two papers, “Research on Multi-Layers” and “Procedure for the Selective Catalytic Hydrogenation of Organic Materials Containing Triple Bonds (acetylene) to Materials Containing Double Bonds (olefins),” a process later patented with Professor Giulio Natta, were early and strong indicators of his life-long research interests: physical and chem-

ical properties of materials, and heterogeneous catalysis.

The years during and immediately following the Second World War presented serious obstacles to scientists in Europe who wished to pursue their research interests actively. Giuseppe Parravano felt isolated from the scientific community

‡ Note: This biographical sketch is an excerpt from remarks made by Giuseppe Parravano’s son, Professor Carlo Parravano, on the occasion of the presentation of the first Giuseppe Parravano Award for Excellence in Catalysis Research at the Eighth Annual Michigan Catalysis Society Symposium (East Lansing, Michigan, May 14, 1985).

and the only solution was to leave Italy for the United States. In 1946, he was awarded a Woodrow Wilson Fellowship to study with Sir Hugh Taylor at Princeton University. The years spent at Princeton were especially important and formative. Sir Hugh Taylor's research group was active, lively, and stimulating, and Giuseppe Parravano's enthusiasm and love for his work thrived in this environment.

In the years 1947–1950, he pursued work in three main areas. One publication during this time concerned itself with the exchange reaction between methane and deuteromethane. Another was a study of the reactivity of the oxides of magnesium and chromium and third was a group of papers that examined polymerization induced by catalytically generated radicals.



Paul Jaronski

Ernestina Parravano, 2000

practical applications of his work.

At the same time, he also worked with collaborators at the Franklin Institute in Philadelphia and the Forrestal Research Center in Princeton. In 1955 Giuseppe Parravano joined the Chemical Engineering Department at Notre Dame University and in 1958 was appointed to the faculty of the University of Michigan where he was a member of the Department of Chemical and Metallurgical Engineering.

His early work at Michigan was characterized by the application of physical chemical techniques to the study of simple chemical systems, which served as models for more complex systems. During his twenty years at Michigan he published nearly 100 papers. A number of these were published in collaboration with colleagues from major research institutions and universities in Italy and the University of Innsbruck. In many of his publications he promoted the use of novel experimental methods for the study of chemical kinetics and reactivity at solid surfaces. In his last ten years he contributed frequently to studies in the areas of electrochemical initiation of polymerization reactions, the measurement and use of

During the following years, Giuseppe Parravano's research goals were oriented to establishing a link between the catalytic activity of a solid and its structure, particularly its electronic structure. For example, he studied the catalytic reduction of CO on nickel oxide and the exchange of hydrogen and deuterium over zinc oxide. Simultaneously, he began an effort to develop mathematical models to describe the operation of catalysts better. In the mid-1950s while still at Princeton University, Giuseppe Parravano began work on studies of the hydrogenation of materials such as benzene on the metals Ru, Rh, Pd, and Pt supported on alumina. Two characteristics recur as threads throughout his work: he closely examined the chemistry occurring on surfaces and also took great care not to overlook practical

chemical relaxation times to elucidate surface kinetics, and measurement of the activity of solid catalysts for oxygen and hydrogen transfer. As an example, in 1968 he published his first Mössbauer study on supported gold. This paper signaled an extensive series of fruitful experiments and was an active area of his research at the time of his sudden death in 1978. Due to the efforts of his collaborators, ten additional papers appeared in this area of study in the years following his death.

Joe Martin of Michigan . . . Professor and Professional (1916–1982)[†]



Joseph J. Martin has established himself as one of the best known and universally admired faculty members in chemical engineering. He received his B.S. from Iowa State University in 1939, and worked for the next two years with the Eastman Kodak Company. Subsequently, he was awarded an M.S. from the University of Rochester in 1944, and obtained his D.Sc. from Carnegie Mellon University in 1948; he was an instructor in chemical engineering at both of these institutions. Coming to the Department of Chemical and Metallurgical Engineering at the University of Michigan in 1947 as an assistant professor, he was promoted to professor in 1956, and has also held a joint appointment as associate director of the Institute of Science and

Technology since 1965. Joe Martin's contributions to chemical engineering have been so pervasive and extensive over the last 40 years that few, except for the new generation of chemical engineers, could not be fully aware of their impact. Yet, it has been for the current and future generations of engineers that his efforts have been targeted. Joe has taken on the mission of developing the framework for the maturation of engineering in general, and chemical engineering in particular, into a profession that takes a responsible leadership in the application of technology to societal needs.

His has been a multifaceted approach, spanning the dimensions of teaching, research, and professional organizations. For many of the 3,000 or more students who have graduated from the Department of Chemical Engineering at the University of Michigan during his tenure on the faculty, his direct influence has been in the classroom and particularly in that abstract and somewhat esoteric field of human invention known as thermodynamics. Joe sees thermodynamics as one of

[†] By Jerome S. Schultz, *Chemical Engineering Education*, pp. 2–5, winter 1982. Joe died on December 13, 1982, just ten days before his 66th birthday. In recognition of his many contributions and excellence in teaching he was to have received one of the 1982 Outstanding Teacher of the Year Awards from the U-M College of Engineering. The award was presented posthumously.

the major intellectual achievements of mankind, in that for all its highly mathematical conceptual basis it concisely summarizes much of the characteristics of the real world. Joe is a master at bringing this realization to undergraduates and graduates alike, along with an ability to apply these principles effectively. He has developed a unique pedagogical approach for teaching thermodynamics, in which he prepared a notebook and slide presentation with each of its 200 panels presenting the essentials of one aspect of thermodynamics. This methodology has gained wide acceptance in the chemical engineering community and has been made available by the AIChE to large numbers of faculty and students throughout the country. Here, he has combined his insight into the logic of thermodynamics and his extraordinary ability as a teacher to set forth the various equations and principles of thermodynamics in a clear, concise, and readily assimilated fashion.

Students recognized Professor Martin's gift of teaching effectiveness nearly thirty years ago by giving him the Phi Lambda Upsilon Teaching Award and this ability has even been enhanced by time. For example, one student recently said, "He is eloquent, not dry and technical. Philosophical interjections provided day-to-day applications and considerations," and another reported "Professor Martin is a very, very excellent teacher in a most difficult course. He explained the tough course matter in a manner that was easy for the students to grasp and like. He made it interesting."

Joe's love and appreciation for thermodynamics has been constant and unwavering over four decades even though the fashionability of the discipline has gone through cycles. Recent world-wide political developments and the realization of the very high economic value of energy has catapulted thermodynamics (or as Joe puts it, the "science of energy") back into the center stage of relevant technology.

Joe and his students have devoted many arduous years obtaining precise thermodynamic data of substances to provide the testing ground for the "Holy Grail" of thermodynamics—a general equation of state. Of his more than 100 publications, nearly a third have been related to this effort. Not one to be distracted when he has decided on a goal or a challenge, Joe has tenaciously battered, chipped, and molded, as a sculptor converts a marble stone into a work of art, to express the refinements and essence of thermodynamics in an aesthetically pleasing equation of state. Much of this effort has been capped in a recent paper with the disarmingly simple title "Cubic Equations of State—Which?" (*IEC Fund.*, **18**, p. 81, 1979).

Joe has always coined charming and interesting titles such as his famous "Antidisestablishmentarianism" (*CEP*, **68**, p. 19, 1972) and "When is a Man Half a Horse?" (*CEE*, **13**, No. 2, p. 73, 1979).

Always prolific in technical writing, October 1981 marked his latest publication: a small book sporting a "maize & blue" cover entitled, "Unified Approach to Series and Integrals of Orthogonal Functions." This is directed in particular toward an advanced study in mathematics.

We would not want to leave the impression that Joe has been single-minded in his pursuit of science. That would omit the other two-thirds of his contributions, which may be overshadowed by his achievement in thermodynamics but in their own right were significant landmarks in other disciplines. For example, recognition of Joe's pioneering work in radiation chemistry led to his election as chairman of the Division of Nuclear Chemistry and Technology of the American Chemical Society (1962) and also to the chairmanship of the Nuclear Engineering Division of the AIChE (1962).

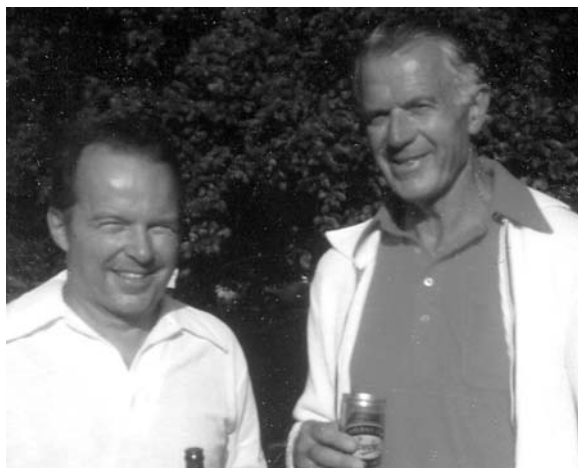

Courtesy Jeff Hunter

Joe Martin (R), in a relaxed moment with his friend John Hunter.

This high level of achievement in teaching, writing, and research, has provided the base of Joe's other long time commitment—the improvement of the professional status of engineering. Simultaneously with his technical activities, Joe has dedicated himself to service to his profession. He has volunteered his services and energies to professional societies, which when taken together, comprise a “Who's Who” of Engineering. He has been president of the AIChE (1971), president of the Engineer's Joint Council (1973–1975), president of the ASEE (1978), and was founder and first chairman of the Association for Cooperation in Engineering (1975–1978). It is through the ACE that his goal of a unified voice for engineering is finally coming to fruition. A very visible result of Joe's efforts is the journal, *Chemical Engineering Education*, which came into being during Joe's tenure in ASEE. He has also served on the Engineer's Council for Professional Development (1973–1980), and is currently chairman of the Education and Accreditation Committee of the AIChE.

He was given an Honorary D.Sc. degree from the University of Nebraska in 1971 and received the Founders Award of the AIChE in 1973.

Why this selfless dedication to his profession? Well, perhaps it is best to quote Joe himself on this: “We have an unusual collection of talent in our memberships, drawn from industry, government, and education, and are capable of directing it in a relevant manner for the best interests of the individual, the specific group, and the nation as a whole. Thus, a profession does not exist in a vacuum—but derives its meaning, value, and goals through both its responsiveness to needs of society and its influence on the direction of society. Being an engineer carries with it a serious responsibility, which must be met in a considered, thoughtful manner by the engineers who are developing the new technologies if these advances are to play a positive role in our society.” Quoting from his Phillips Lecture entitled, *No Engineer Can Serve Two Masters—or Can He?*: “My contention is that more is generally accomplished by bringing people together than by pulling them apart. The interveners who seek to attain their goals, no matter how worthy, through divisive techniques are far less likely of eventual overall success. Their efforts to pit engineers against their employers are based on an asserted advantage to the public, but this is dubious.”

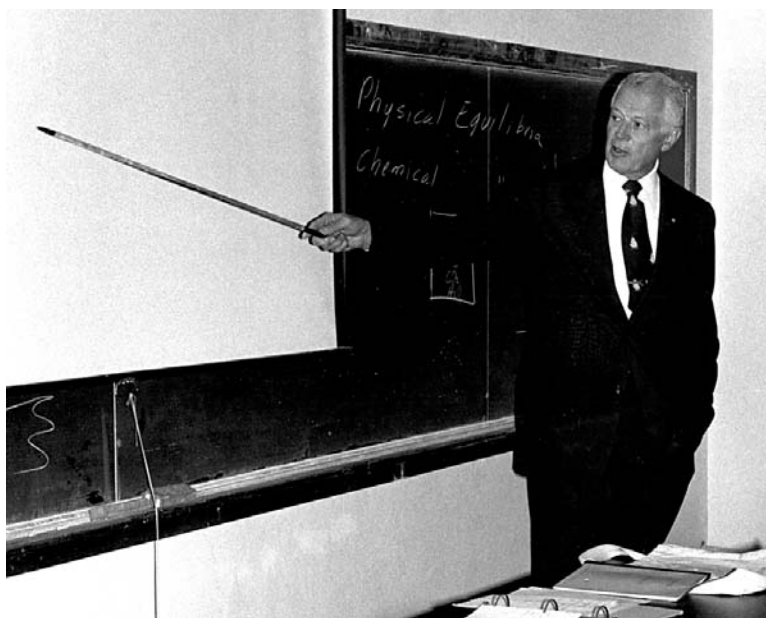

Joe Martin, teaching thermodynamics.

In these times when there has been an awakening of the need for better university/industry cooperation, it is remarkable that Joe has been a catalyst in this area for the last fifteen years. About half of Joe’s university appointment during this period has been in the Institute of Science and Technology of the University of Michigan. As associate director of IST, (and acting director from 1978 to

1981), he has led an effort to bring industry and university leaders together in conferences, workshops, and study groups. More than twenty-five “state of the art” monographs have resulted, ranging in topics from the highly technical *Data Processing Fundamentals* to the more prosaic *Vacation Housing*. Through Professor Martin’s work in IST, he has been an integral part of research in the office of the vice-president for research and is a member of the Macromolecular Research Center Executive Committee.

Those who know Professor Martin well are aware that just as he is synonymous to thermodynamics, so too is he to tennis; he approaches this recreational game with the diligence and aggressiveness mostly accredited to professional tennis players.

Born in Iowa and raised in Omaha, Nebraska, at the young age of 12, Joe acquired his affinity for the sport from his father, Joseph Wesley Martin, a school teacher and an avid tennis player. Joe took the game seriously and was on his varsity tennis team at the University of Rochester, followed by competitive playing for over 35 years in the Ann Arbor City and university faculty tournaments. Having been in the finals many times, as recently as August, 1978, he won the “Ann Arbor Men’s Singles—Over 40” title against contenders 22 years his junior. The newspapers aptly dubbed him “King of the Court!”

Although Professor Martin belongs to three tennis clubs, he says he enjoys playing at the University of Michigan Track and Tennis Building “best” because of the “fast-action” of the wood boards.

Arriving at the office in East Engineering Building at 7:30 AM every morning and always being punctual for classes and meetings, he begins his busy schedule, deftly arranging (sometimes almost surreptitiously) sufficient time in the day—for tennis. Playing with colleagues and students during noon hours, or just practicing on the backboards for an hour or two is an essential part of his day.

An inveterate traveler, logging some 30,000 miles/year during the height of his involvement in society work, he never leaves home without a tennis racquet in hand—nearly always having pre-planned a game or two over the phone or by letter before the trip. But if not, he quickly negotiates one when he arrives, since he has “tennis friends” everywhere in the country.

Last fall, Joe required surgery to replace his right hip joint. One of his concerns was, “Was this going to bring his playing of the game he loved so much—to an end?” Fortunately that is not the case; now, even though he plays “just doubles,” he is back on the courts. A 6-ft 4-in. charisma-endowed player, agile at 64, and using his great power of concentration, he is still competitive; but most of all “happy” to be playing tennis again, one of his first loves!

Together with the weight and extent of Joe Martin’s professional responsibilities, he has involved himself in community service and has been a dedicated family man. Mrs. Martin (“Terry”) has traveled far and wide with Professor Martin and

has always been his strong supporter. The Martin's children are all out of the "nest." The youngest, Jon, just graduated from Wisconsin at Madison and is now living and working in Texas. Joe Jr. and Judy both live and work in the San Francisco area, while Jacque lives near Ann Arbor with her husband, Ed, and two children, Stephanie and Teddy.

Diplomatic, astute, skilled lecturer, international authority, Joe gives the impression that all these remarkable traits and accomplishments have "just happened" as a matter of course, for his is an unhurried manner, an almost unbelievable controlled "ease," and a sincere concern for his fellow man. It is clear that this outstanding educator and this grand gentleman lives his life by the Golden Rule.

Indeed, the Department of Chemical Engineering at the University of Michigan is extremely proud and deeply honored to count Joseph J. Martin as one of its members.

Faculty Rosters in 1948 and 1980

It is appropriate to repeat here—in Table 10—the list of faculty members sent out by G.G. Brown in a news bulletin in connection with the 50th anniversary of the department (celebrated on 8 May 1948).

Table 10 Chemical and Metallurgical Engineering Faculty, 1948

George Granger Brown	Richard E. Townsend
Albert E. White (Director of the Engineering Research Institute)	David W. Monroe
John C. Brier	James W. Freeman
Clair Upthegrove	Franklin B. Rote
William P. Wood	Maurice J. Sinnott
Donald L. Katz	Lloyd E. Brownell
Richard Schneidewind	Joseph J. Martin
Leo L. Carrick	Charles M. Moesel
Lars Thomassen	Julius T. Banchemo
Donald W. McCready	J. Louis York
Clarence A. Siebert	Cedomir M. Sliepcevich
Alan S. Foust	Brymer Williams
Robert R. White	John E. Myers
	Charles M. Thatcher
	Edwin H. Young

Table 11 also lists our faculty members at the end of the era depicted in this chapter.

Table 11 Chemical Engineering Department Faculty, 1980

<i>Name</i>	<i>Degree(s)</i>	<i>Title</i>
Dale E. Briggs	Ph.D., P.E.	Professor
Brice Carnahan	Ph.D., P.E.	Professor
Rane L. Curl	Sc.D.	Professor
Francis M. Donahue	Ph.D.	Professor
H. Scott Fogler	Ph.D., P.E.	Professor
Robert H. Kadlec	Ph.D., P.E.	Professor
Lloyd L. Kempe	Ph.D., P.E.	Professor
Howard Klee	Sc.D.	Adjunct Professor
Joseph J. Martin (Acting dir., Inst. Science & Tech.)	Ph.D.	Professor
John E. Powers	Ph.D.	Professor
Jerome S. Schultz (chairman)	Ph.D.	Professor
Maurice J. Sinnott (associate dean)	Sc.D.	Professor
M. Rasin Tek	Ph.D., P.E.	Professor
James O. Wilkes	Ph.D.	Professor
G. Brymer Williams	Ph.D., P.E.	Professor
Gregory S.Y. Yeh	Ph.D.	Professor
Edwin H. Young	M.S., P.E.	Professor
James H. Hand	Ph.D.	Associate Professor
Erdogan Gulari	Ph.D.	Assistant Professor
Johannes W. Schwank	Ph.D.	Assistant Professor
Henry Y. Wang	Ph.D.	Assistant Professor
James R. Falender	Ph.D.	Adjunct Asst. Prof.
David Hammer	M.S.E., P.E.	Lecturer
Arun Hejmadi	M.S.E.	Lecturer
Donald L. Katz	Ph.D., P.E.	Professor Emeritus

Chapter 7

PHOTOGRAPHIC INTERLUDE 1: CAMPUS SCENES



Paul Jaronski

Burton Tower is named for former U-M president Marion Leroy Burton, and contains the world's third-heaviest carillon, named after the former athletic director Charles Baird; the 55 bells were cast in 1936 and 1975 by the John Taylor & Co. Bellfoundry, Loughborough, England.



James Wilkes

East Engineering (now East Hall) from the southwest. July 2000.



Paul Jaronski

Looking north to the Horace H. Rackham School of Graduate Studies.



The “Engineering Arch” in the West Engineering Building (now renamed West Hall), taken from the northwest. July 2000.

James Wilkes



James Wilkes

The president’s house, South University. July 2000.



James Wilkes

The revolving 2,400-pound “cube,” on Regents’ Plaza, with John Ellis of Chulalongkorn University in Bangkok, May 2000. It was designed by U–M alumnus Bernard Rosenthal and was commissioned by the Class of 1965. Source: Joanne Nesbit, U–M News and Information Services.



Paul Jaronski

The Earl V. Moore Building, North Campus home of the School of Music.



James Wilkes

The “diag” from the northwest, fall 1956.



James Wilkes

Demolition of East Hall (just north of East Engineering), April 1961. The building was originally Tappan Elementary School in the Ann Arbor school system, but was used later by engineering students for classes in mathematics and engineering English.



James Wilkes

Looking southeast across North Campus, March 1961. The Phoenix Memorial Laboratory is at right center, and the Walter E. Lay Auto Laboratory is behind the trees at left center. The Ann and Robert H. Lurie Tower now occupies a location near the truck in the center.



James Wilkes

North University Street, with Hill Auditorium, Sept. 1955.

Chapter 8

THE CHURCHILL YEARS

STUART W. CHURCHILL

Chairman, 1961–1967

STUART W. Churchill, a native of Imlay City, Michigan, matriculated at the University of Michigan in 1938. As an undergraduate he played clarinet in the Marching and Concert Bands, undertook a research project on retrograde phase-behavior with Donald L. Katz, and received B.S.E. degrees in both chemical engineering and mathematics in 1942. Following graduation, he joined the Shell Oil Company, serving as technologist at Wood River, Illinois and Houston, Texas. In 1946 he became technical supervisor for the Frontier Chemical Company, a new enterprise in Denver City, Texas.



Stuart W. Churchill, 1956

In 1947 he returned to the University of Michigan for graduate work, completing his Ph.D. in 1952 under the direction of Professor John Crowe Brier. He began teaching as an instructor in 1950 and was promoted to assistant professor, associate professor and professor in 1952, 1955, and 1957, respectively. In 1967 he accepted the Carl V.S. Patterson Chair of Chemical Engineering at the University of Pennsylvania. Throughout his career Churchill has been active in research, teaching, consulting, and professional activities. His research and publications have spanned fluid mechanics, heat transfer, mass transfer, reaction kinetics, and combustion; his work has generally focused on the interaction of experimentation, analysis, and numerical computation. His recent efforts have been directed towards the synthesis of experimental data, numerical solutions, and asymptotic models to predict turbulent flow and convection. He has published six books and about 300 papers. In his 15 years as a faculty member at the U–M he supervised 27 dissertations, served on another 48 doctoral committees, and wrote 78 publications.

His teaching at both the University of Michigan and the University of Pennsylvania has focused on transport processes and he has written related textbooks:

The Interpretation and Use of Rate Data, Inertial Flows, and Viscous Flows. He is currently completing a companion volume, *Turbulent Flows*. He has been a pioneer in the use of computers for modeling chemical and thermal processes and in the development of comprehensive correlating equations based on asymptotic solutions.



Mary Ann Wilkes

It was during this spring 1959 visit to Madingley Hall, Cambridge, that Stuart Churchill invited Jim Wilkes (L) to return to the University of Michigan.

Churchill enjoys seeking out new challenges, both in teaching and research. During the department's Centennial, he mentioned that he appreciated the process of discovery in research. "Sometimes you don't end up in the direction of your original aim," he said, "but come upon something perhaps more important. For example, we studied how to reduce the noise of a jet engine, and as a by-product designed a process that eliminates pollutants. This process then became more of a direct interest."

From 1957 to 1962 he served as program advisor for the Science Engineering Program and from 1962 to 1967 as chairman of the Department of Chemical and Metallurgical Engineering Department. His tenure as chairman was noteworthy for a turnover of 50% of the faculty. During his term of office he oversaw the development of challenging new areas of study. These included such diverse areas as bioengineering, process dynamics, computer applications, pollution control, reservoir engineering, catalysis, sonochemistry, and polymer rheology. To support these curriculum changes, Churchill also recruited outside faculty who could bring fresh approaches to the department. Profs. Briggs, Carnahan, Curl, Donahue, Fogler, Goddard, Kadlec, Schultz, and Wilkes all were hired during Churchill's term.

While a faculty member at the University of Michigan he served on many committees, including the Presidents Commission on Year-Around Operation, the

Board of Control of Intercollegiate Athletics (vice-chairman 1964 to 1967) and the Senate Advisory Committee on University Affairs (vice-chairman 1961 to 1962).



James Wilkes

Punting on the Cam—Stuart Churchill & Mary Ann Wilkes, Cambridge, spring 1959.

Professor Churchill has been active in the AIChE throughout his career, serving as a founding member of the Heat Transfer Division in 1958, as a national director from 1961 to 1967, and as president in 1966. His honors include the Professional Progress, William H. Walker, Warren K. Lewis, Founders, and Heat Transfer and Energy Conversion Division Awards of the AIChE as well as the Max Jakob Memorial Award of the ASME and AIChE. He was chosen in 1998 as the AIChE Institute Lecturer. In 1974 he was elected a member of the National Academy of Engineering and in 1983 was designated by the AIChE as one of 30 “Eminent Chemical Engineers of the Quarter Century.” In 1983 he was chosen as the first Corresponding Member of the Verein Deutscher Ingenieure. From the University of Pennsylvania he was given an honorary M.A. degree in 1971, the S. Reid Warren Jr. Award for Excellence in Teaching in 1977 and in 1992 its first medal for distinguished achievement. In 1968 and 1969 he was a member of the first two teams to win the annual Four-Mile Relay Championship of the AIChE for faculty members. In 1985 the Center for the History of Chemistry (now the Chemical Heritage Foundation) prepared an oral history on his career.

At Michigan, Churchill was known as a sports enthusiast with a dazzling memory for details from football and basketball games, and a competitor in running, tennis, and skiing. He and some of his colleagues had a regular weekly golf game during the summers in Ann Arbor. His present interests include classical music and gardening, but his real hobby, Churchill says, is work: “I really enjoy doing my chemical engineering work more than anything else.” He formally retired in 1990 but he has remained active in teaching, research, scholarly writing, and

professional work.



Renate Churchill, at Stuart's 60th birthday dinner, Univ. of Pennsylvania, 10 June 1980. Renate is a former editor of "International Chemical Engineering."



245th Commencement, University of Pennsylvania, Philadelphia, 21 May 2001; Prof. Stuart W. Churchill and his grandson Stefan C. Zajic.

None of Stuart Churchill's four children chose careers in engineering, but his oldest grandson, Stefan Zajic, a resident of Chelsea, Michigan, graduated in chemical engineering at the University of Pennsylvania in 2001. Stefan and Stuart presented five joint papers at the AIChE Annual Meetings in Los Angeles in 2000 and Reno in 2001. Stefan spent the summer of 1999 doing research with Ralph Yang at the U-M, which resulted in his first publication.

REFLECTIONS, BY STUART W. CHURCHILL

Research

My first experience with research was as an undergraduate student. Under the direction of Donald L. Katz, William C. Collamore and I investigated the phase behavior of the ethylene/acetylene system. This work was a little frightening to us because of the sensitivity of acetylene at high pressure to explode, and was also both frightening and uncomfortable because it was carried out by only one of us at a time in an isolated cold room. We were, however, rewarded for these risks by our discovery and documentation of the retrograde characteristics of these mixtures. We were also astonished but pleased when Don literally dictated a manuscript to be submitted for publication as we described the experiments and results to him orally on the last day before our graduation. This experience was one of the factors that encouraged me to return to Ann Arbor after the war to seek a Ph.D. and thereby an opportunity to teach and carry out research.



Stuart Churchill, with the equipment used in research with Jack Brier on the ignition of solid propellants and also in his own doctoral research.

My own doctoral research under J.C. Brier, which involved forced convective heat transfer to cylinders at extreme temperature differences, utilized facilities that I had helped to design, construct, and operate for his research on the ignition of solid propellants under the sponsorship of first the Army Office of Ordnance and then the Navy Bureau of Ordnance. Although both the sponsored and then the doctoral research were primarily experimental, I was able to make critical contributions by virtue of my then exceptional background in mathematics. Several lessons from this experience have greatly influenced my subsequent research:

1. The recognition that mission-oriented and basic research may be complementary and synergetic.
2. The personal discovery of the coupling of chemistry and heat transfer in combustion.
3. The demonstration that mathematical modeling can benefit experimentation.
4. The realization that local measurements of a rate process are much more revealing than overall ones.

Following my appointment as an assistant professor, I briefly continued research on the ignition of solid propellants in collaboration with Brier, as is reflected in the doctoral work of Roy W. Kruggel, as well as research on the effect of high temperature differences on forced convection, as is reflected in the doctoral research of Herbert E. Zellnik and a publication with W.J. Murray Douglas*, but I also ventured into other topics.



James O. Wilkes

Peter H. Abbrecht, 2000

One of my first doctoral students, Peter H. Abbrecht, measured the velocity and the temperature fields in a stream of air, as well as the local heat-flux density at the wall of an isothermal tube in developing turbulent flow and convection. Because of their precision, these measurements permitted the determinations of eddy diffusivities and their ratio that have remained a standard of reference to this day. They also are a unique source of experimental evidence that the turbulent transport of energy is independent of geometry and of the temperature field within the fluid, and hence of the thermal boundary condition on the wall. Strangely, this proof of independence has been of critical importance in my current research on turbulent convection forty years later.

At this same time, I began a career-long study of natural convection under the prompting of William R. Martini, whose interest arose from personal experiences

* An asterisk denotes collaborative work either arising from a seminar project (not necessarily with one of SWC's own doctoral students), or from sponsored non-doctoral research.

with the detonation of hydrogen/oxygen mixtures in water-cooled nuclear reactors, a problem that was the real threat in the Three-Mile-Island incident twenty-some years later. Digital electronic computers were just becoming widely available and I suggested that he attempt to supplement his experimental measurements of the temperature and velocity fields inside a partially heated and partially cooled horizontal cylinder by solving the coupled partial differential equations of conservation for momentum and energy by finite-difference methods. The IBM 650 computer available to him proved to be inadequate for this purpose, but his successful solution of the energy balance using his own experimental velocity field was very encouraging. This complementary undertaking of experimentation and theoretically based computations has characterized most of my subsequent research—numerical modeling in the interests of generality, scope and precision, and critical experiments to test the validity and applicability of the model. Doctoral students usually resist one or the other of these approaches because of a lack of self confidence, but in the end are generally more proud of their accomplishments in the venue they tried to avoid.

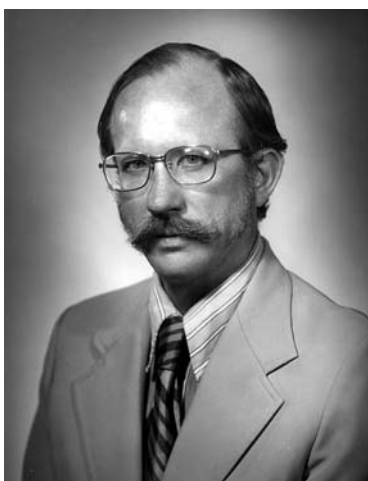

Jesse D. (“Dave”) Hellums

J. David Hellums, who subsequently had access to an IBM 704 computer, succeeded in solving the coupled set of partial differential equations for the conditions of Martini’s experiments as well as for free convection from a heated vertical plate, in both cases including the transient behavior. This work, which ingeniously applied the upwind method in the locally appropriate direction, was the first solution for two-dimensional natural convection using a digital computer and is now recognized as one of the landmarks in the analysis of heat transfer. It is difficult today to realize the impact of this work at that time. The reactions ranged from disbelief to astonishment to enthusiasm to downright indignation. The latter response cited the inelegance and unfair competition of numerical methods.

James O. Wilkes, using an IBM 7040 computer, extended the work of Hellums significantly by solving the model for the strongly two-dimensional velocity and temperature fields in rectangular regions. Jim was somewhat taken aback by the appearance, just before the completion of his work, of an analytical solution in the form of a doubly infinite series for some of his conditions. Of course, this concurrent work, which was only for the steady-state behavior in a square region, actually strengthened his results by providing an exact completely independent numerical confirmation. Wilkes’s results have remained a benchmark for the countless subsequent numerical investigations of natural convection in an enclosure.

Michael R. Samuels continued this general line of research by investigating the behavior in a rectangular channel heated from below. His experimental work proved to be critical in determining the stable mode of circulation to be postulated in the finite-difference modeling. Dudley A. Saville, at about the same time, initially undertook to develop a finite-difference solution for free convection outside a heated cylinder but was diverted by his discovery of an integral transformation that generalizes the solutions for free convection in the thin-laminar-boundary-layer regime for horizontal cylinders and vertical axisymmetric bodies with arbitrary contours. His rapidly converging solution and its numerical implementation virtually closed that subject. This description of my research on natural convection is limited to that at the University of Michigan, but it perhaps should be noted that continuation of the work began by Martini, Hellums, Wilkes, Samuels, and Saville led to five more doctoral theses and over fifty more publications after I moved to the University of Pennsylvania.



James Wilkes

Robert Kadlec, Michael Samuels, Brice Carnahan, and Dudley Saville, attending Stuart Churchill's 60th birthday celebrations, Univ. of Pennsylvania, 10 June 1980.

A fourth initiative at the onset of my career as a faculty member involved radiative transfer through the atmosphere under the initial sponsorship of the Armed Forces Special Weapons Project and eventually under the Defense Atomic Support Agency, the Army Chemical Corps, the Office of Naval Research and the National Science Foundation. This work was begun in collaboration with C.M. Sliepcevich and was continued throughout in collaboration with C.M. Chu of the Department of Electrical Engineering. It was enhanced by the direct involvement of P.J.W. Debye, G.E. Uhlenbeck, and S. Chandrasekhar as consultants. Despite the primary sponsorship of agencies of the Department of Defense, most of the results of this

work were published in the open literature. These publications, which will not be mentioned in detail here, were primarily on the effects of *anisotropic* as opposed to the usual idealization of *isotropic* scattering. Several volumes of computed values of light-scattering and associated mathematical functions were published by the U–M Engineering Research Institute. In addition, the experimental technique and equipment, and the theoretical methodologies associated with the sponsored research were almost all utilized or enhanced by doctoral or other academically oriented research. Examples follow.



Li-Chiu Tien

The doctoral research of J.H. Chin under Myron Tribus resulted in a new method for determining particle-size distributions by light scattering. Also, George C. Clark in his doctoral research defined the optimal effect of the proximity of individual particles in very dense dispersions. Bert K. Larkin in his doctoral research defined the contribution of thermal radiation to heat transfer through fibrous and foamed insulation, determined the optimal fiber or pore size, and derived the first numerical solutions of the Maxwell equations for the interaction of electromagnetic radiation and cylinders. L.B. Evans extended the latter solutions for hollow and coated cylinders. John C. Chen in his doctoral research determined the contribution of radiative transfer to heat transfer in packed beds. C.A. Sleicher,*

M.H. Friedman,* and L.C. Tien* studied transient radiative heating of dispersions, radiative heating of sprays of fuel droplets, and approximations for radiative transfer through dispersions, respectively. Almost every one of these investigations involved a combination of numerical modeling (principally the solution of integral equations) and experimental measurements. Although the doctoral research of Carl G. Vinson involving the removal, by means of screens, of liquid droplets suspended in another liquid, was in itself unrelated to radiative transfer, its success was a result of the application of the method developed by J.H. Chin for the determination of particle-size distributions by light scattering.

Combustion-related studies in a completely different context from that with J.C. Brier were begun with the doctoral research of Morton P. Moyle and Roy L. Gealer, who predicted theoretically and measured the effects of low initial temperature and high initial pressure, respectively, on detonation. The latter work was sponsored by the Office of Naval Research. Martin E. Gluckstein and Irving F. Miller thereafter conducted their doctoral research on shock-induced reactions. Non-doctoral research on the effects of ionizing radiation on combustion was carried out by R.L. Gealer,* R.J. Kelley,* L.F. Ornella,* and M.E. Gluckstein* in

collaboration with Alexander Weir and under the sponsorship of the Air Force Office of Scientific Research.

The doctoral research of Donald W. Sundstrom on heat transfer to the inside wall of a tube from a flame stabilized by a bluff body, under the sponsorship of Esso Research and Engineering, was intended to determine the effects, if any, of the chemical reactions, but revealed instead the much greater influence of acoustical resonance. The doctoral research of William N. Zartman was accordingly directed to the determination of the factors that characterize and intensify this resonance, which is responsible for jet-engine noise. The doctoral research of Thomas D. Bath on thermally stabilized combustion was intended to eliminate this source of noise. It not only did that, but this new process of combustion proved in continued studies after I left the University of Michigan to eliminate almost wholly the formation of NO_x and to have many other unique and favorable characteristics.



Some of Stuart Churchill's U-M doctoral graduates who attended his 80th birthday celebrations. Top row: Larry Evans, Warren Seider, Jim Wilkes, and Dave Hellums; bottom row: John Chen, Charles Sleicher, Stuart Churchill, and Dudley Saville. University of Pennsylvania, 17 April 2000.

The study of the storage and transport of liquefied natural gases as a consultant to Chicago Stockyards Research and several corporate successors in collaboration with C.M. Sliepceвич led to publications on transient conductive heat transfer with A.S. Teller,* W.D. Seider,* L.C. Tien,* and L.B. Evans,* and eventually to a study at the University of Pennsylvania of the migration and freezing

of water in the soil with J.P. Gupta.

An exploratory research program on the use of a plasma for carrying out high-temperature chemical reactions, in collaboration with R.H. Kadlec and R.E. Balzhiser under the sponsorship of the National Science Foundation and the Bethlehem Steel Corporation, led to the doctoral theses of George R. Chludzinski, Dean Smith, George Quarderer, and Finis Carleton, all of whom completed their work after I relocated.

Some isolated research undertakings that may be mentioned are:

1. Home heating by means of the induced flow of air through the ground, under the sponsorship of the Washington Water Power Association, as carried out by Peter H. Abbrecht.*
2. Convective deicing of aircraft, sponsored by the Wright Air Development Center and carried out with Morton P. Moyle* in collaboration with Myron Tribus.
3. Concurrent two-phase liquid flow and mass transfer as the doctoral research of R.G. Rigg and J.A. Leacock.
4. Jet mixing and reaction as the doctoral research of W.D. Seider.
5. Enhancement of heat transfer inside tubes by the use of turbulizers as the doctoral research of L.B. Evans. This work was started under the direction of Robert R. White.
6. Nuclear reactor dynamics in collaboration with the Argonne National Laboratory as the doctoral research of W.K. Luckow.
7. Simplification of boundary and initial-value problems as well as the derivation of similarity transformations with J.D. Hellums.*
8. The development of improved theoretical models for convective and conductive heat transfer with R.E. Balzhiser* and R.L. Gorrington*, respectively.

Four characteristics now follow of my research that may not have been planned or anticipated but that may now be inferred from the above descriptions.

1. Much of the research of my doctoral students was unsupported and non-programmatic because the students were recipients of industrial and governmental fellowships that did not restrict their field of study.
2. Most of the direct financial support of my research came from the Department of Defense. On the whole, this support was free of any restrictions on publication and even free of any direct military applications. For example, an administrator of the Air Force Office of Scientific Research once told me they were receptive to proposals for fundamental research on any aspect of combustion. Unfortunately that long-range and enlightened view is no longer prevalent with either industrial or governmental sponsors.
3. My own students as well as those of other faculty members often carried out publishable research initiated by a seminar project. In other instances publishable results arose from sponsored non-doctoral research. The asterisks following the name of a student identify efforts in one of these two categories.

4. My research covered a large number of seemingly unrelated topics. When I was a young faculty member, D.L. Katz noted this dispersion of my efforts and stated that I must focus my work more narrowly if I wished to be famous and successful. Obviously, I did not heed that advice. I have always found exploratory research to be the most exciting as well as the most productive in terms of really new findings. Accordingly, I have generally abandoned a line of research as soon as the first-order effects were well defined. The exceptions have been when the research revealed unexplained behavior. This policy was possible, if not recommended, during my career at the University of Michigan because, as mentioned above, the direction of the research of most of my doctoral students was not restricted by financial considerations. Unfortunately, that situation no longer prevails in engineering anywhere.

Teaching

Teaching activities are more difficult to describe and characterize than those of research. I will only mention a few of my experiences and perceptions.

My teaching was of course primarily influenced by my own teachers and my own classroom experiences as an undergraduate and graduate student, not only in chemical engineering but also in mathematics, physics, chemistry, and mechanical engineering. As a young faculty member, I was strongly influenced by several joint teaching experiences with other faculty members. I was fortunate to have the opportunity to observe the performance of almost every faculty member in the Department of Chemical and Metallurgical Engineering of that era in one or more of these settings. Since I was planning to be a teacher by the time I was a graduate student, I evaluated their performance at the same time as I was listening to their message. Their styles ranged from intimidation, belittlement, and sarcasm to gentlemanliness and patience, from disorganization to over-organization, from exhortation to the Socratic method, from enthusiasm to ennui, and from monotony to the unpredictable. Those who shared this era with me will have no difficulty in associating these styles with particular individuals. Although the faculty members in chemical engineering were often absent from the classroom and their office due to professional-society or consulting activities, they were generally accessible otherwise. My preference for an open door rather than fixed office hours is based on my own experiences as a student. Whatever their style, most of the faculty members gave a high priority to teaching, and appeared to believe in the importance and validity of the subject matter they were presenting. Many flavored their presentations with new concepts from their current research and consultation.

Collaborative mentoring by D.L. Katz, J.J. Martin, Myron Tribus, and R.R. White in the context of teaching, and J.C. Brier and C.M. Sliepcevich in research, contributed immeasurably to my development as a faculty member, and I tried to play this role of mentor with J.D. Goddard, R.H. Kadlec, D.A. Saville, J.O. Wilkes, and others. A few of these experiences are described in some detail below.



James Wilkes

Warren Seider with his wife, Diane. Together, they organized Stuart Churchill's 80th birthday celebrations at the University of Pennsylvania, April 2000.

Don Katz, on becoming chairman, proposed that he teach the graduate course in fluid mechanics and heat transfer jointly with J.G. Knudsen and me once, and thereafter withdraw from that activity. He further proposed that he would present the tried and true, and that Jim and I would each introduce new topics and new approaches. It was implied that we would attend each other's presentations. The pressure to perform well both competitively and in the presence of my chairman and mentor was very high, and it is fair to say that Jim and I, with the guidance of Myron Tribus in the seminar described below, brought the content of that course up to the frontier of the field in one discrete step, thereby somewhat anticipating the contents of the book *Transport Phenomena*, which appeared a few years later, but of course in our case over a narrower range of topicality. As a result of this experience, I have been inclined to upgrade all my graduate courses by introducing about 20% new and advanced material each time, and have for that reason avoided the use of textbooks, except as references, in favor of notes.

A collateral, formative experience also occurred at about the same time. Myron Tribus, in collaboration with Jim Knudsen and myself, conducted a seminar in fluid mechanics and heat transfer. Myron, Jim, and I, as well as each of some dozen graduate students, made one or more presentations and prepared written summaries thereof on advanced topics chosen by Myron, and then each of the students undertook a theoretically based research project. This course was a great success, except perhaps as an interruption of the doctoral research of the partici-

pating students, and I continued to conduct such seminars throughout my tenure at the University of Michigan, usually in collaboration with one or more faculty colleagues. This is an effective mechanism for self-learning and updating for both faculty and students. However, the greatest benefit may be the realization by the students that they are already capable of doing original theoretical work at the frontier of the field. The latter is attested by the many publications in archival journals that have been based on the seminar reports. One such study was by Ward Winer, a U–M student in mechanical engineering, now dean of engineering at the Georgia Institute of Technology; although it didn't result directly in a publication, the work predicted that a flame could be stabilized by radiation alone inside a refractory tube. This prediction led me to a career-long study of that process of combustion and its consequences.



Robert R. White.

A third formative, collaborative experience was that of developing a completely new approach to chemical engineering with R.R. White. His initiative and original concepts were the critical element. My resulting book, *The Interpretation and Use of Rate Data: The Rate Process Concept*, which was published after he left the academic world, has been more of an artistic than a financial success, but my efforts were more than repaid by the unique insight gained in its preparation.

One other academic experience had a profound and lasting influence on my teaching. When I was a doctoral candidate, one of the requirements was a minor, consisting of three or more advanced courses in each of the two fields other than chemical engineering. This led me to elect courses in mathematics from R.C.F.

Bartels, R.V. Churchill, and others, courses in chemistry from L.O. Brockway, L.O. Case, and others, and courses in physics from E.E. Barker, D.M. Dennison, Otto Laporte, and G.E. Uhlenbeck. The material I learned in these courses has been a unique and invaluable resource in both teaching and research over my entire career. Unfortunately, the time allocated to both seminars and external course work has been greatly reduced at the University of Michigan and elsewhere due to the unwillingness of faculty members to allow their own doctoral students to divert their attention from the sponsored research that now provides their financial support.



Barnett F. Dodge.

My first experience as a graduate student was earthshaking and possibly a critical juncture in my entire career as a teacher. I arrived a few minutes late for my first class, which was in thermodynamics, because of a longer and slower queue to buy concert tickets than I had anticipated. As I entered Room 1042 of East Engineering I heard my name being called by G.G. Brown. I replied, "Here," only to be told loudly and brusquely, "I know you are here, what is the second law of thermodynamics?" I responded shakily and briefly and started to sit down, but he said, "Don't sit down," and continued to grill me on this topic for the entire hour. I apparently passed muster because he didn't call on me again all semester. I was very fortunate to have had some preparation in depth for this encounter. I did not have a course in engineering thermodynamics as an undergraduate, only thermodynamics as a segment of physical chemistry, but on the suggestion of Don Katz I had spent some time the spring before returning to Ann Arbor, while

working for the Frontier Chemical Co. in Denver City, Texas, self-studying the new book *Chemical Engineering Thermodynamics* by Barnett F. Dodge.

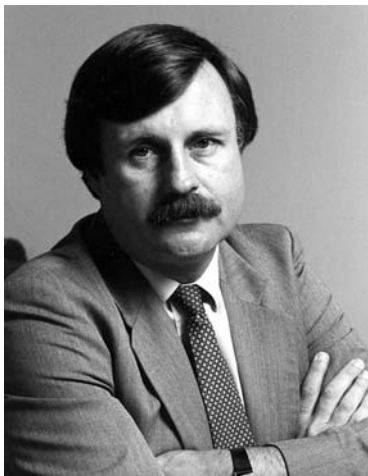

James R. Street

Two years later, with no advance warning, Brown called me to his office and offered me a half-time instructorship. After gaining the approval of J.C. Brier, for whom I was working as a research associate in the Engineering Research Institute, to drop back to half-time in that position, I accepted and was informed by Brown that my first assignment would be teaching two sections of CM 2 starting the next day. I ran out of my prepared lecture material after 30 minutes that first day and in self-defense sent the students to the blackboard to work problems from their textbook. I found this procedure, which I had also experienced as a student, very effective in terms of identifying the difficulties encountered by both the individual students and the class as a whole. and continued it as a regular

part of most of my subsequent undergraduate courses. One serendipitous result was the immediate identification of the exceptional capabilities of students such as James R. Street and Richard E. Balzhiser, both of whom I offered positions as research assistants after their first class. With graduate students, I have found that asking one of them to write out their solution to a homework problem on the blackboard and then defend it to me and the class has similar benefits but is more appropriate for their level of maturity and their need for experience in oral presentation. I was appreciative of teachers who were willing to be interrupted to explain some non-obvious point to me. Hence, I have always tried to encourage students to ask questions at once when they are puzzled or disbelieving. I still recall one graduate student, Robert Ackenburg, who challenged almost everything I said with “You’re wrong!” Eventually the other members of that class protested to me that I was devoting too much attention to these interruptions. I did ask him to think a few moments before he spoke, but also explained to the class that most of his challenges, even if unsupported, were worth our collective consideration.

Not wanting to be caught so unprepared as I was in my first semester of teaching, and hoping to learn of my future prospects, I asked Brown a few days later what course or courses I might be assigned the following semester. He suggested that I sit in on the section of CM 113 being taught by D.L. Katz, in which he was using as a text the preliminary version of a section of the soon-to-be-published *Unit Operations*. Don’s face brightened when he spotted me in the rear of his classroom and called me to his office at the end of the hour. He gave me a copy of the notes and graciously volunteered that he would give me the opportunity to

practice teaching the course if he were ever away. He was away about 50% of the time thereafter in connection with an assessment of the Athabasca tar sands. A few days later Cheddy Sliepcevich offered me the same privilege with the respect to his section, pointing out that no additional preparation would be required on my part. This heavy teaching load, together with my continuing responsibilities in the sponsored research of J.C. Brier, significantly delayed progress on my own doctoral research, but that was a sacrifice I was more than willing to make in view of the valuable experience I gained as a teacher and the possible opportunity for a permanent position.

The Chairmanship

From my first days as an undergraduate in 1938 to my departure in 1967, an almost complete turnover occurred in the faculty. World War II forced the appointment of a number of doctoral students as instructors to replace the older faculty members who were on military leave. Most of them were subsequently given permanent positions. The elimination of the course requirements in metal processing resulted in the elimination of the department of that name and the reassignment of a number of that faculty to the Department of Chemical and Metallurgical Engineering. Their mostly early retirements, together with normal retirements and a number of defections to administrative positions in other universities, provided for a large turnover.



Stuart Churchill, when chairman of the department, at his East Engineering desk.

During my tenure as chairman from 1962–1967, 15 new faculty members were hired. Up until World War II, a significant fraction of the doctorates in chemical and metallurgical engineering were produced by two schools—the Massachusetts Institute of Technology and the University of Michigan. A collateral effect was that most industrial fellowships and grants were given to these two schools because the

real purpose of the sponsors of the fellowships and grants was to foster the identification and acquisition of the best students. It was therefore not unreasonable that these two schools preferentially hired their own students as faculty members.



James Wilkes

John Dealy and Brice Carnahan, at Stuart Churchill's 60th birthday celebrations, Univ. of Pennsylvania, 10 June 1980.

In the 1950s the support of academic research and thereby of graduate students by the federal government, and in particular by the Department of Defense, increased dramatically, and was distributed more widely. As a consequence, the doctoral programs in chemical engineering blossomed in many schools. For this reason, and to avoid the effects of academic inbreeding, I became an advocate of hiring doctoral graduates of other schools for our faculty. In the long run this view prevailed. We made a few justifiable exceptions: Dick Balzhiser, Dale Briggs, Brice Carnahan, Don Frye, Bob Kadlec, Jim Street, and Jim Wilkes. Looking back, there are some downside tradeoffs to hiring only external candidates: a difficulty in maintaining positive traditions, in developing loyalty and a sense of community and in constructing a consensus regarding the appropriate direction for the department in research and teaching. The dependence of individual faculty members on research grants and contracts further weakens their personal commitment to the department and the university as a whole.

As chairman and later dean, G.G. Brown was accessible and very open—indeed, he enjoyed debating with the faculty. (He always won the debate by skill and intimidation, but afterwards often accepted your proposal.) At the same time he was not completely democratic. As an example, when the university decreed that the doors of all the buildings be locked in the early evenings, several faculty members proposed at a departmental meeting that a vote be taken as to whether graduate students would be allowed to have keys or not. Brown simply said, “You

may vote whichever which way you please but it will not make any difference since I will not issue any such keys.” Don Katz was much more democratic and utilized an advisory committee to assist in decisions on salaries, promotions, etc. As chairman I continued that policy and benefited greatly from the advice of Don Katz, Joe Martin, Maurice Sinnott, Larry Van Vlack, Brymer Williams, and Louis York. During a partial leave as a concession to my responsibilities as president of the AIChE, I learned a lesson which the department has since often failed to heed. An acting chairperson, however well-meaning and capable, is essentially helpless in the university system. They have no leverage in their dealing with the dean, while in the department anyone opposed to a decision will either attempt to bypass the acting chairperson or wait for the appointment of a permanent one. Such interim appointments should be avoided or at least minimized in length. G.G. Brown apparently recognized this problem because he continued as chairman while he was the director of research for the AEC at Oak Ridge, Tennessee, despite only infrequent appearances in Ann Arbor.



The clock that James O. Wilkes presented to Stuart Churchill when he visited the University of Michigan in 1980, recognizing the “timeless quality of his lectures.”

When G.G. Brown became dean he strengthened his power by weakening that of the departmental chairmen. He did this by shifting responsibilities for the teaching programs to program advisors that reported directly to him. When Steve Attwood succeeded Brown as dean the opposite trend occurred, in part owing to his temperament but perhaps more owing to his chronic illness. Gordon Van Wylene, who was chairman of the Mechanical Engineering Department, and I found that, by acting jointly and when necessary bypassing the acting dean and going directly to the academic vice-president, we could operate quite autonomously in

what we conceived to be the best interests of the two departments.

When Van Wylen succeeded Attwood as dean the center of power shifted once more. One day he attempted to persuade me to require the students in the Chemical and Metallurgical Engineering Department to take a freshman course in materials that we taught. I explained that we preferred to teach materials science to our own students after they had taken physical chemistry. He then said, “Stuart, why don’t you drop the parochial interests of the department in the best interests of the college?” I responded, “Gordon, you are talking just like a dean.” He momentarily flushed with anger and then laughed. We won that battle but lost others. For many years we required a 2.5 or better average to graduate with a B.S.E. in chemical or metallurgical engineering. This had the psychological effect of attracting the best students and diverting the poorer ones to other departments. Gordon forced us to drop this requirement as unfair.



College of Engineering Media & Marketing

Gordon J. Van Wylen, who was dean of the University of Michigan College of Engineering from 1965 to 1972.

The problem with deans, as I alluded to in connection with Gordon Van Wylen, is that, although they were undoubtedly selected in part because they were superior teachers and/or researchers, they no longer have much opportunity to practice these pursuits once they become dean. Their critical interactions are with the upper administration and potential donors rather than with the faculty, and they

soon tend to forget that the important accomplishments of the university occur only in the classroom, laboratories, and associated venues. The simplest cure appears to be the imposition of a limited and nonrenewable term for that position.

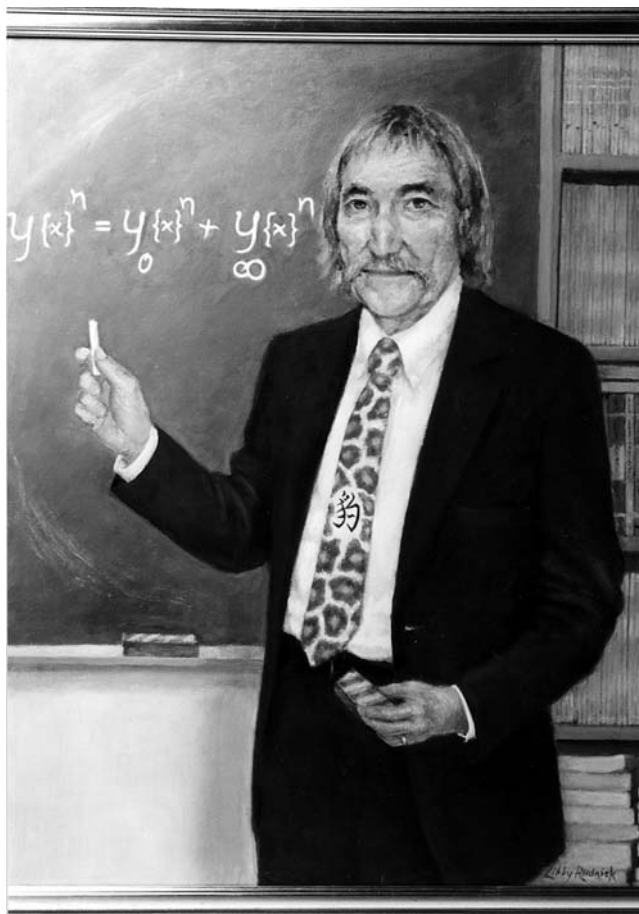

Oil painting of Stuart Churchill, by Libby Rudnick, presented to him by his former doctoral students during the celebrations of his 80th birthday, University of Pennsylvania, 17 April 2000. The blackboard contains Churchill's famous equation for interpolating between two asymptotic or limiting solutions.

As I neared the end of my five-year term as chairman of the Chemical and Metallurgical Engineering Department in 1967, my visibility in that position and as an officer of the AIChE and ECPD (the predecessor of ABET) led to invitations from a number of schools to be dean or provost. I was flattered but not tempted. These

invitations did prompt the realization that I far preferred teaching, research, and scholarly activities to administrative duties, even as chairman. The offer by the University of Pennsylvania of the Carl V.S. Patterson Chair in Chemical Engineering, which promised support and recognition for just those activities, materialized at that time and I accepted. In retrospect, this decision was indeed in my best professional and personal interests. The special place of the U–M Department of Chemical Engineering in my heart has, however, not diminished with time.

80TH BIRTHDAY CELEBRATION

An 80th birthday celebration for Churchill was organized by Warren and Diane Seider and held on 17 April 2000 at the University of Pennsylvania. In the afternoon, Prof. Charles A. Sleicher gave a light-hearted talk, “Wine, Song, and Chemical Engineering.” Then followed a reception and the unveiling of a portrait of Stuart by artist Libby Rudnick, which was presented to Churchill by his former doctoral students.

An evening dinner was held at The Inn at Penn; several short speeches included those made by some of Stuart’s former U–M doctoral students—Dudley Saville, Warren Seider, David Hellums, Jim Wilkes, Larry Evans, and John Chen. The man honored for accomplishing so much—Stuart Churchill—made a suitable rejoinder.

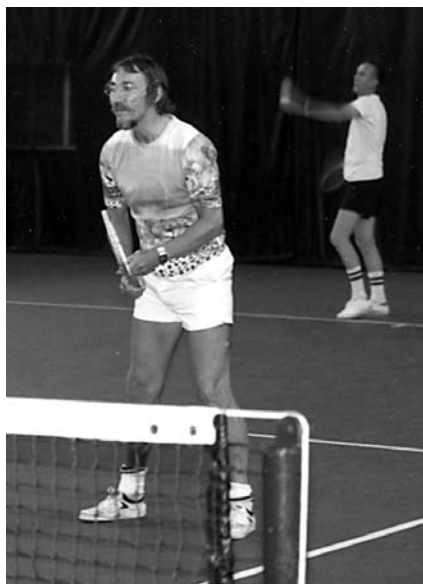

Stuart Churchill playing tennis on the eve of his 60th birthday; the server is probably Joe Martin.

A biographical sketch of Stuart Churchill and his research accomplishments was subsequently published by all of his doctoral students: “Professor Stuart W. Churchill on his 80th Birthday,” *International Journal of Heat and Mass Transfer*, **43**, pp. 4213–4215, (June 2000).

Chapter 9

1967–1977, DURING WHICH WE BECOME A SEPARATE DEPARTMENT

LAWRENCE H. VAN VLACK
Chairman, 1967–1970

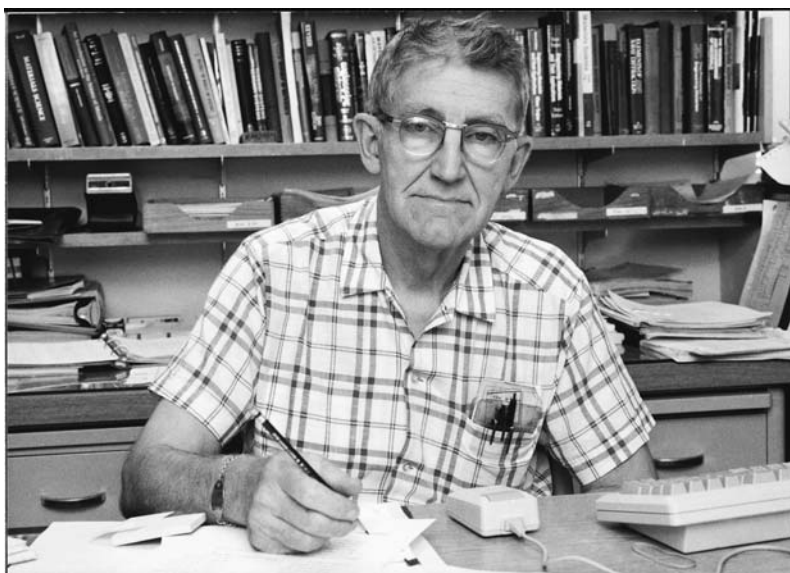

Lawrence H. Van Vlack.

AFTER Stuart Churchill had left for the University of Pennsylvania in 1967, Lawrence (“Larry”) H. Van Vlack was appointed chairman of the Chemical and Metallurgical Engineering Department. Larry was born July 21, 1920 in Atlantic, Iowa, the son of Claude and Ruth (Stone) Van Vlack.† In 1942 he earned his bachelor’s degree from Iowa State University and went to work at U.S. Steel, Inc. in Chicago and Pittsburgh. He served in the U.S. Navy from 1949–1950, then earned his Ph.D. at the University of Chicago. From 1953 to 1988 he was a faculty member at the University of Michigan, first in the combined “Chem/Met”

† We gratefully acknowledge the *Michigan Engineer*, spring/summer 2000, for details of the life of Prof. Van Vlack.

department, and (from 1971) in the newly formed Materials and Metallurgical Engineering Department. He was the chairman of the Department of Chemical and Metallurgical Engineering from 1967 to 1971.



Neal R. Amundson (Univ. of Minnesota)—the DLK Lecturer for 1972—and Lawrence H. Van Vlack.

Larry was widely credited with establishing materials science as a separate discipline with his classic, *Elements of Materials Science*, first published by Addison-Wesley in 1959. This book, and subsequent editions, have been used by more than one million students in the United States and have been translated into nearly 30 foreign editions.



Bill Wood

Ronald Gibala

Larry was a dedicated and caring teacher, scientist, and engineer. His devotion to materials education is legendary. His educational and scientific accomplishment were widely recognized by his peers, who bestowed upon him fellowships in the American Association for the Advancement of Science, the American Ceramics Society, the American Society of Engineering Education, and the American Society of Metals. Perhaps more importantly, he was remembered fondly by all students that he came in contact with. Larry was also an extremely loyal supporter of the College of Engineering. He and his family endowed the L.H. and F.E. Van Vlack Professorship of Materials Science and Engineering, first held in 1998 by Ronald Gibala. Professor Emeritus Van Vlack died Thursday, January 21, 2000 in Kalamazoo, Michigan.

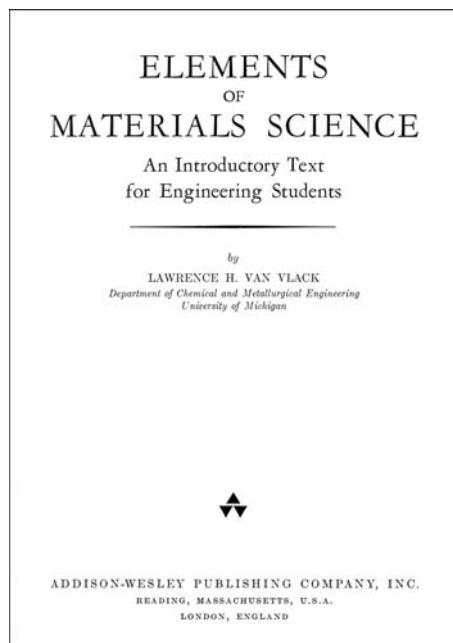

Title page of the first edition, 1959.

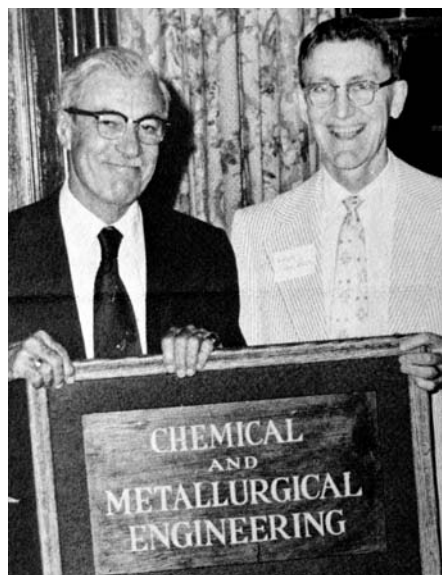

Donald Katz and Larry Van Vlack with the sign of their former combined department.

THE UNIVERSITY OF MICHIGAN
ANN ARBOR
COLLEGE OF ENGINEERING

OFFICE OF THE DEAN

November 5, 1969

MEMORANDUM

TO: Members of the Faculty, Department of
Chemical and Metallurgical Engineering

FROM: Dean Gordon J. Van Wylen

The Executive Committee is grateful to each of you for your response to the proposal which was recently submitted to you. The Executive Committee has reviewed each of these replies, and recognizes more fully than ever that there are many facets to this issue.

We have, however, concluded that in the long-run both Chemical Engineering and Materials and Metallurgical Engineering, as well as the college as a whole, will be best served if there are two departments. We further believe that we should attempt to develop the closest possible ties between the two departments, and optimize the budgetary and personnel resources in areas of mutual interest.

There are of course many specific decisions which must be made in implementing this overall decision, and we are anxious to do this in a manner in which each individual will be best served. With this goal in mind, we propose to proceed as follows:

1. The Department of Chemical and Metallurgical will be divided into two divisions; namely, the Division of Chemical Engineering and the Division of Materials and Metallurgical Engineering. No regental action will be taken at this time, and for budgetary purposes in relation to the central administration there will be only one department. Faculty members will be members of one division or the other (in exceptional cases a faculty member might have a joint appointment in the two divisions). Separate divisional faculty meetings will be held with joint departmental faculty meetings being held as a necessary to discuss matters affecting the entire department.

2. A chairman for each division will be named. Professor Van Vlack will serve as chairman for the Materials and Metallurgical Engineering division and as department chairman. An interim chairman for Chemical Engineering will be named from the present staff. The Executive Committee will ask each faculty member in Chemical Engineering to submit his nomination(s) for an interim chairman. At this time it is not quite clear as to whether the target date for selecting a permanent chairman should be made the fall of 1971 or the fall of 1972. A decision on this will be made in September 1970. The interim chairman would have the normal responsibility and authority of a department chairman for the Division of Chemical Engineering, except as he works out items of mutual interest and concern with Professor Van Vlack. He would attend meetings of the Standing Committee, and would assume leadership in staff recruitment.

3. At the time a permanent chairman for Chemical Engineering is named, the recommendation to the Regents will be made to establish two separate departments.

By the late 1960s, a significant move was afoot to split the department into two separate departments, one to reflect the chemical engineering interest and the other to represent materials and metallurgical engineering. There were good reasons—and strongly expressed viewpoints!—for and against such a separation, and the memorandum on November 5, 1969, from Dean Van Wylen, reproduced on page 171, summarizes the two-stage evolutionary process that was adopted.

Professor Van Vlack continued as chairman of the still-combined department and also as chairman of the Materials and Metallurgical Engineering Division. Professor Richard (“Dick”) E. Balzhiser was appointed chairman of the Chemical Engineering Division in 1970.

RICHARD E. BALZHISER

Chairman, 1970–1971

THE final separation occurred in 1971, and thus Dick Balzhiser became the first chairman of the “new” Chemical Engineering Department. But his chairmanship was only for a very brief period, because in late summer of 1971 he took a leave of absence (which eventually became permanent) to serve as assistant director in the Office of Science and Technology, in Washington, D.C., where he worked closely with Ed David, scientific advisor to President Nixon.



Richard E. Balzhiser.

Dick Balzhiser was born in 1932 in Elmhurst Illinois, but received all of his degrees from the University of Michigan: B.S.E. (ChE, 1955), M.S.E. (Nuclear Engineering, 1956), and Ph.D. (ChE, 1961). His doctoral dissertation was entitled *Third-Component Interactions with the Uranium/Bismuth System*. His research

interests were largely in heat transfer and thermodynamics, with an emphasis on liquid metals. He was an Academic All-American fullback for two of his undergraduate years as well as a highly successful student.



Richard E. Balzhiser in less formal attire—with W.O. Carleton (L).

Dick was a charismatic and very likeable person with a keen interest in politics, and served as a White House Fellow in the Kennedy administration while a young faculty member. While he was still in Ann Arbor, he served on the Ann Arbor City Council, also running for mayor, missing victory by a narrow margin. With M.R. Samuels, and J.D. Eliassen, Balzhiser coauthored a well-known textbook, *Chemical Engineering Thermodynamics—The Study of Energy, Entropy and Equilibrium*, Prentice Hall (1972). A further appreciation of Dick's outstanding abilities and career appears on page 549.

JAMES O. WILKES

Chairman, 1971–1977

EVENTS moved swiftly, and James Wilkes was appointed in 1971 at extremely short notice to serve as acting chairman of the new department. He subsequently served a five-year appointment as chairman, from 1972–1977. His biographical sketch appears on page 537. With the massive new faculty hiring that occurred in the 1960s, and a doubling of the undergraduate enrollment during 1971–1977, there was very little scope for extending or reinforcing our research interests. The early 1970s were relatively lean years for funding of the College of Engineering, student tensions were still evident during and after the Vietnam War, and there was considerable faculty schism on whether or not to seek an

outside chairman. Thus, much of Jim's efforts were directed in maintaining cohesion within the department. Just two new faculty members—Jim Hand and Fred Bader—were added in the early 1970s. The years 1971–1977 saw a significant increase in our undergraduate enrollment and in that of women, and five major gifts were secured for the department—those of the DuPont Company, Dr. Charles A. Lunn, Dr. Walter J. Podbielniak, the Herbert H. & Grace A. Dow Foundation, and the Harry A. & Margaret D. Towsley Foundation.



James O. Wilkes.

Table 12 gives a snapshot of our faculty in 1972 and their research interests. However, events during Wilkes's tenure as chairman are best summarized by reproducing the words that he wrote for five issues of *TechniUM*, the College of Engineering magazine published during the 1970s.

TechniUM—Fall 1974

Chemical engineering is a medium-sized department. We separated formally from materials & metallurgical engineering three years ago but still maintain close working ties with them. This year we had 175 undergraduates, 50 graduate students, and 18 faculty members. Student interest in chemical engineering is currently strong, with 80 students taking our introductory course this year; a noticeable number are transferring from LS&A. Recently we have annually been averaging about 50 bachelor's degrees, 18 master's, and seven doctorates. The relatively small entry into the master's program is almost entirely rate-limited by the available industrial support, but the quality of students entering in fall 1974 will be the highest on recent record. We are very pleased to see an increasing number of women students, who now account for 8% of our enrollment.

**Table 12 Chemical Engineering Faculty and
Their Fields of Specialization, Fall 1972†**

Balzhiser, Richard E. (On leave.) Heat transfer and thermodynamics, liquid-metal technology, use and reuse of energy and material resources.

Briggs, Dale E. Air and water pollution, computer control, heat transfer, adsorption, solvent refining of coal.

Carnahan, Brice. Digital computation, numerical mathematics, optimization, engineering and medical applications of digital computers.

Curl, Rane L. (Graduate committee chairman.) Dispersion, pollution control, residence-time distributions, simultaneous mass transfer and chemical reaction, carbonate technology.

Donahue, Francis M. Electrochemistry; fuel cells, batteries, electroplating, corrosion and corrosion inhibition, electrosynthesis.

Fogler, H. Scott. Kinetics and mass transfer in porous media, fluid mechanics, sonochemical engineering.

Goddard, Joe D. Fluid mechanics, rheology, polymers, mass and heat transfer.

Hand, James H. Molecular rheology, polymers, hydrodynamics, boiling heat transfer.

Kadlec, Robert H. (Undergraduate program advisor.) Process dynamics and control, modeling and simulation, reactor engineering.

Katz, Donald L. (A.H. White University Professor of Chemical Engineering.) Petroleum, natural gas, underground storage, information systems, engineering education projects.

Kempe, Lloyd L. Biochemical engineering (industrial microbiology). Food and pharmaceutical industries. Industrial waste and water treatment.

Martin, Joseph J. (Associate director of the Institute of Science and Technology.) Thermodynamics, energy conversion, properties and statistical thermodynamics, applied mathematics, radiation chemical engineering.

Parravano, Giuseppe.§ Polymers and polymerization reactions; theoretical and experimental studies in heterogeneous catalysis and solid surfaces, thermodynamics and kinetics of solid-state reactions.

Powers, John E. Separation processes, experimental determination of thermodynamic properties.

Schultz, Jerome S. Biochemical engineering, production of pharmaceuticals by fermentation, gas absorption, transport phenomena in membranes, biomedical engineering.

Sinnott, Maurice J.§ (Associate dean of the College of Engineering.) Physical metallurgy and materials, physical properties of fluids.

Tek, M. Rasin. Applied fluid mechanics, petroleum engineering, two-phase flow, underground storage of natural gas, mining from the ocean.

Wilkes, James O. (Chairman of the department.) Numerical methods, fluid mechanics, polymer processing, underground storage of natural gas, two-phase flow.

Williams, G. Brymer. Separation processes, vapor/liquid equilibrium, process design and synthesis.

Yeh, Gregory S.Y.§ Polymers.

Young, Edwin H. Process design, process-equipment design, heat transfer.

† Wilkes, James O., et al., "Michigan," *Chemical Engineering Education*, pp. 60–64, Vol. 7, No. 2, Spring 1973.

§ Denotes joint appointment with the Materials and Metallurgical Engineering Department.

After spending two years in Washington, Dick Balzhiser resigned from the department a year ago. His new position is director for non-nuclear research with the Electric Power Research Institute in Palo Alto, but he still finds time to return to act as “color-man” with Bob Ufer on WPAG radio during football season. At 9 AM on Friday, 19 April, 1974, Don Katz, properly attired in academic dress, presented the last regular course of his career in ChE 585 (*Petrochemicals*). He is dipping his foot into the waters of retirement by taking a 10% retirement furlough next year; with the remainder on sponsored research, he will continue, we anticipate with some trepidation, as actively as ever. One new person is coming in August—Fred Bader, with a Minnesota Ph.D. following a Michigan B.S.E. His specialty is biochemical engineering, and this will add much-needed reinforcement to a popular undergraduate option, developed over many years by Lloyd Kempe. We were sorry to see our department secretary, Alvalea May, leave after seven years; she moves with her husband to Escanaba.

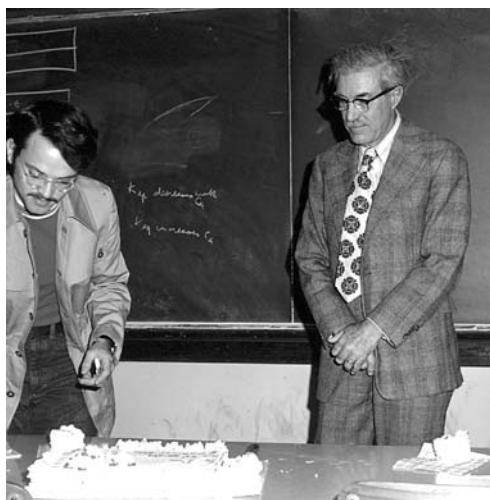

James Wilkes

Bruce Deschere serving cake after Donald Katz's last lecture (but not yet retirement), 19 April 1974. Presidency of the U-M AIChE Student Chapter ran in the family, and was held by Bruce ('72-'73), his brother Mark ('69-'70), and his wife-to-be, Linda Marcon ('73-'74).

Our faculty continue to participate widely in college affairs. Maury Sinnott, having returned from Washington, has been elevated to the peerage as associate dean of the college, but finds time to help in the classroom. Jim Hand directed the college effort in the national SCORE project (Student Competitions on Relevant Engineering—although we thought that engineering was always relevant!). The theme of “Students Against Fires” involved innovative design in fire control, and two of his student groups received second and third prizes in the national competition at Marinette. The working models involved were an automated forest-fire detector and a device for fire-fighting from an adjacent floor in a high-rise building.

During the year a decision was made to reorganize our undergraduate laboratories: ChE 231 (*Thermodynamics*) and ChE 344 (*Rate Processes*) will be

restructured into a single new three-hour course that will emphasize bench-scale experiments and some open-ended (multiple-solution) projects. The ChE 460 laboratory will continue with its larger-scale, equipment-oriented projects. One section of our undergraduate chemical reaction engineering course was taught for the first time under the Keller Plan, an individualized system of instruction that allows the student to advance at a speed commensurate with his/her ability and other demands on their time; it was warmly received by the students.



James Wilkes

“Madge” Ingerson and Alvalea May (secretary to the chairman), at the latter’s farewell party, East Engineering, 4 June 1974.

We are grateful to Roger Campbell, an alumnus with Marathon Oil, for contributing a current sulfur-recovery problem to the graduate design course. His participation was highlighted by a class trip to the Detroit refinery, where the students were shown Marathon’s actual design and given a tour of the plant under construction. The graduate-student seminar program for the year concluded with the fourth Katz Lectureship and a social evening. The recipient—the first from overseas—was Prof. J.R.A. Pearson, from Imperial College London, who talked on “The Flow of Polymers with Application to Melt Processing.”

Our microbiological teaching and research laboratories will soon find a permanent home in the Water Resources Building, now nearing completion on North Campus. We shall no longer have to beg and borrow space from the Medical School.

Renovation projects underway involve part of the biochemical engineering research laboratories, and the new ChE 360 laboratory, both in the G.G. Brown Laboratories. As a joint project with M&M in East Engineering, the polymer teaching laboratory is undergoing extensive renovation. A recently renovated polymer research laboratory, made possible by a gift from alumnus “Doc” (Charles A.) Lunn, is fully in use by Jim Hand and his students.



James Wilkes

This East Engineering third-floor office—of a nationally recognized Michigan chemical engineer—was hands-down winner of the Pooh-Bah “piled paper” award for the year.

In addition to frequent Friday afternoon sessions at the Village Bell, there have been many other extra-curricular activities this year. The faculty/graduate student picnic was held in September, at the chairman’s house. A large turnout (including spouses and friends) did full justice to the steaks and beer; badminton and other games of chance were played until 4 AM. Emeritus faculty were represented by Nepo Thomassen, Jack Brier (now 85 and living at the Michigan Union), and Dick Townsend and his wife. Dick has just been inducted into the Emeritus Club of the U–M Alumni Association.

Many friendships were renewed in Philadelphia at the AIChE meeting last November. A large crowd attended our annual alumni social hour; preparation for this event was materially assisted by alumnus Jeff Kerner, and we look forward to greeting everybody again in Washington this December. Joe Martin, a recent AIChE president, received the Founders Award at the Philadelphia meeting; he is now President of the Engineers Joint Council. We are also very proud to record that one of our students, Dave Hammer, entered the AIChE National Student Design Contest last year, and won first place for his design of an allyl chloride plant; in recognition, he received the A. McLaren White Award at the Philadelphia

meeting. His efforts are all the more noteworthy since he was married during the four weeks allotted for the problem, took the last ten days off, and handed the solution in early.



James Wilkes

David Hammer (R), seven years after his AIChE success, with (L to R) John Ulicny, “Fanny” Bolen (at his retirement dinner), and James Hand, 28 April 1981.

The AIChE student chapter continues its noon luncheons every Wednesday, with speakers from industry and the U–M; the food continues to be unsurpassed. Their president, Linda Marcon, was recognized with the Student Chapter Award by the Detroit Section of the AIChE. The student chapter chartered a bus and organized a departmental plant trip to Dow Chemical; alumnus Bob Copeland was the host, and the tour included visits to the Dow Environmental Research Laboratory and the salicylic acid plant.

Finally, let me take this opportunity to say that we always like to hear—and receive visits—from our alumni.

TechniUM—Spring 1975

Our long-standing interest in energy-related fields continues. During the 1973–1974 academic year, a departmental team (Dale Briggs, Donald Katz, John Powers, Rasin Tek, and Brymer Williams) undertook a major study for the Electric Power Research Institute; they investigated the most promising processes for producing sulfur-free liquid and gaseous fuels from coal, notably those involving fluidized-bed combustion, coal beneficiation, pyrolysis, gasification, and liquefaction. Briggs is pursuing a problem related to the solvent-refining of coal, that of filtering unwanted solids from the liquid extract. The filtration rate is retarded not only by the build-up of undesirable inorganic solids, but also by the streaming-potential induced

precipitation of asphaltene solvents within the diatomaceous earth filter precoat material; the relative importance of these effects is being examined.

Tek and Katz lead our natural-gas research. In an American Gas Association project, conditions are predicted under which natural gases will form condensates in pipelines; methods for the removal of accumulated liquids are also under study. In the Michigan Gas Association Fellowship Research Program, current investigations involve: (a) the Oranje effect, in which liquid condensate in natural gas pipelines may preferentially flow into a branch off a main pipeline, (b) the suitability of western lignites for coal gasification, and (c) the design of “closed-loop” slurry pipelines for transporting coal, mineral residues, and other commodities.



James H. Hand

Jim Hand’s research is proceeding on three different fronts. First, with Katz and V.K. Verma, he examined the formation of crystalline hydrates from water and hydrocarbon liquids, with applications to Arctic oil-field recovery and the hydrate deposits on the continental shelf. Continuing work involves five-phase equilibria with two hydrate phases. Second, high-speed photography is being used to investigate the large increases in pool-boiling heat transfer achieved with certain dilute polymer solutions. The normal transition to film boiling at large driving forces appears to be inhibited by a large resistance to bubble coalescence in the effective solutions. Third, with a team including Gregory Yeh, new ceramic/elastomer and glassy carbon/elastomer composites are being developed

with a view to direct skeletal attachment of artificial limbs.

In the Thermal Properties of Fluids Laboratory, John Powers and T. Miyazaki have constructed a recycle-flow calorimeter for operations up to 3,000 psia and temperatures from -250°F to 350°F ; isobaric, isothermal, and isenthalpic data for ethane near the critical point showed that basic measurements are thermodynamically consistent to $\pm 0.1\%$. The facility was also used by K.Y. Kim for measurements on argon and hexafluoroethane, in order to develop generalized thermodynamic correlations. Also, with Powers, L.A. Farrant has investigated the hydrometallurgical recovery of transition-series metals using organic liquid anion- and cation-exchanges.

Joe Goddard is using rheo-optical birefringence measurements for studying strain and orientation phenomena in polymer fluid filaments generated in commercial fiber-spinning. He is also collaborating with Jerome Schultz in two areas. The first is a team effort with the U–M Department of Surgery and Internal Medicine to evaluate the compatibility of materials in contact with blood; a procedure is being

developed for measuring the rate of thrombus development on artificial materials in living animals. The second is an extensive theoretical treatment of facilitated transport across membranes containing reactive species, with applications in water purification by dialysis and reverse osmosis, and in the transport of nutrients and drugs in biological tissues. In related work, S.R. Suchdeo has studied the transport of carbon dioxide across films containing sodium bicarbonate and enzyme carbonic anhydrase, and D.J. Fink has investigated the properties and kinetic behavior of enzymes, such as trypsin, rendered insoluble by microencapsulation inside semi-permeable nylon membranes.

Also as part of our biological research program, Lloyd Kempe is investigating lake sediments as a source of phosphorus under conditions of carbohydrate addition. Experiments indicate that settleable water from creameries, canneries, and paper mills can cause dissolution of stored phosphorus, producing pore-water concentrations common to those in sewage. Gas-lift transport of nutrients from anaerobic regions of sediment to overlying water is also under investigation.

Scott Fogler and K. Lund have studied the kinetics of solution of dolomite, calcite, and feldspars in HCl/HF mixtures, with applications to the stimulation of petroleum-bearing sandstones. Subsequent research is directed towards the acidization of clay-saturated sandstone. In a joint study with Goddard, 20-kHz ultrasonic waves are being used for ammonia synthesis in hydrogen-saturated liquid nitrogen.

Working with Brymer Williams, E.E. Timm has used high-speed cinematography to investigate the collapse of spark-generated bubbles in water; the results are correlated with cavitation-induced surface damage. In the Wolverine-Tube Project with Edwin Young, local condensing and evaporative heat-transfer coefficients are being examined for falling films on doubly fluted vertical tubes.

Jointly with the U–M Department of Anthropology, Rane Curl is using chemical engineering techniques to facilitate the separation of different forms of carbonized botanical remains. He has also correlated the size of naturally induced surface roughness with the velocity of air flowing past a soluble surface.

Giuseppe Parravano's research is in three main areas. First, basic studies of catalytic surfaces determine the rate of chemical and physical events occurring at the surface during the course of a chemical reaction. Second, conversion electron Mössbauer spectroscopy elucidates the crystal chemical details of the iron/nitrogen surface interaction, with potential applications to the development of improved catalysts for ammonia production. Third, the electrochemical polymerization of organic monomers affords a novel method for treating monomers that will not polymerize conventionally, and also for depositing protective polymer films on metal surfaces.

In Francis Donahue's electrochemical research, studies in mixed potential systems have provided the most complete kinetic and mechanistic analysis of the

electroless copper-plating process. Also, the modeling of electrochemical reactors has led to a design algorithm that has successfully been demonstrated for the electro-refining of copper.

Robert Kadlec conducts research in three interdepartmental areas—CICE (Computer, Information, and Control Engineering), mechanical engineering, and the U–M School of Natural Resources. First, he is exploring the dynamic behavior of an ethanol/water flash vaporizer; L.M. Joseph has shown that the cycling of the flash-drum pressure improves the separation for high-feed qualities. A second project, with the Environmental Protection Agency, investigates the performance of catalytic reactors for automotive emission control, with emphasis on the kinetics of oxidation of sulfur compounds. The third and largest project concerns the feasibility of the use of wetlands for tertiary sewage treatment at Houghton Lake, Michigan. In this project, P.E. Parker has written REBUS, a modular approach for simulating ecosystems. Work continues on the bacteriological aspects of sewage decomposition, on the rates of nitrogen cycling between soil, water, and air, and on the motion of adsorption fronts into the wetlands.

With Dale Briggs and Brice Carnahan, L.A. Lopez has written DYSCO, an interactive executive program for the dynamic simulation of a chemical plant. By incorporating unsteady-state models for individual processing units and controllers, simulations can be made of plant start-ups and shutdowns, perturbations of operating conditions, and the behavior of control systems. Carnahan also reports a novel photoreactor; light is generated inside the reactor by capturing beta radiation (emitted by an encapsulated radioactive nuclide) in a phosphor mounted on small spheres covered by a transparent silicone coating.

TechniUM—Winter 1975/1976

Our long-awaited microbiological teaching and research laboratories in the Water Resources Building on North Campus are now in operation, complete with freezers and culture-preparation and sterilization rooms. Thus, in the 1975 fall term, not only were we teaching our microbiology course for the first time in our own facilities, we were also offering a new freshman course in biochemical engineering. The former Measurements Laboratory in East Engineering has been extensively renovated and is in use as a polymer teaching laboratory. This remodeling, together with the acquisition of a blown-film line and a screw extruder, has allowed us to add a polymer processing course and a freshman plastics course. The new color scheme for the laboratory (turquoise and flaming peach) was chosen by Jim Hand, and is surely the envy of the avant-guard interior decorator.

After four years as undergraduate program advisor, Bob Kadlec has stepped down and Frank Donahue has taken over. In 1970 our undergraduates numbered about 145; there are now almost 200. Between 1973–74 and 1974–75, enrollment in our beginning course jumped by 40%; a still larger incremental increase is expected

in 1975–76. A noticeable number of these students have been transfers from LS&A.

Student activities. Our undergraduates made a particularly fine showing at the Spring Engineering Honors Luncheon. Of the eight special college awards open to general competition, our students received four—the Distinguished Scholar Award (Rick Rykowski), the Marian Sarah Parker Award (Karen Bilich), the Tau Beta Pi Award (Rick Peterson) and the Andrew A. Kucher Award (Mike Duncan). Duncan, working with Scott Fogler, has written a series of interactive educational computer games for ChE 342 (*Chemical Reactor Engineering*). Provided you have a sound knowledge of rate laws and CSTRs, you can get involved in the real cloak-and-dagger stuff by assisting Columbo in solving the “Mystery of the Missing ChE Professor.” (No, we don’t mean the one that’s never in his office—everybody knows who he is.) Or, if you get your kinetics just right, you can take exactly the right amount of cyanide antidote and thereby precisely neutralize the deadly bacteria you’ve recently ingested.

The AIChE Student Chapter arranged two field trips during the year, one to the EPA Motor Vehicle Emissions Laboratory in Ann Arbor, and the other to the Dow Chemical Company in Midland. The student officers under President Gary Wilson worked hard and efficiently, and the group received the Student Chapter Award from the Detroit section of AIChE. Another field trip was organized by Rasin Tek, who completed three years on the college’s Executive Committee during the year; his petrochemicals class made a bus trip to Amoco’s drilling site and cryogenics plant in Kalkaska.

Research. Although there have been no major shifts in research emphasis since my last report in TechniUM, a few new areas have opened up.



Robert D. Pehlke

Jointly with Prof. Robert D. Pehlke, chairman of the M&M Department, Jim Wilkes has initiated a new project on the plasma-arc remelting of steel. Also, there are two new projects in biochemical engineering. First, photomicrography is being used for observing dynamic changes in mixed-culture microbial populations; the goal is to correlate failures and changes in the efficiency of a biological water-treatment process with changes in the distribution of the different types of microorganisms involved in the process. Second, the effect of microorganisms on coal slurries during pipeline transportation is being investigated, with attention to the problem of converting sulfur to sulfuric acid in the pipeline. In addition, slurring pipelining is being studied from the viewpoint of two-phase fluid mechanics.

These coal-slurry projects are examples of the additional emphasis we have been placing on coal research, and for which (along with oil-shale studies) we have received four NSF Energy Traineeships. There are additional projects in the coal area. Work has started on the application of basic chemical engineering principles to the devolatilization of coal in coal gasifiers of different configurations. A group of projects related to the filtration step in the solvent-refining of coal area are also in progress. These include investigations into the molecular weights and rheological properties of coal asphaltenes, and their adsorption on the diatomaceous earth used in the filtration pretreatment process.

Although government agencies (notably NSF and NIH) have provided the major part of our research funding, there has been an encouraging amount (and diversity) of support from a variety of industrial organizations.

Faculty activities. Scott Fogler received a Fulbright scholarship and spent the year on sabbatical leave with the Institute of Chemistry at the University of Bergen, where he studied the chemical kinetics of acidized oil reservoirs. His text, *The Elements of Chemical Kinetics and Reactor Engineering*, has been published by Prentice-Hall. Giuseppe Parravano has also received a Fulbright for the winter 1975–1976; he'll be studying and lecturing in materials science and heterogeneous kinetics at the Institute of Physical Chemistry in Innsbruck.

Brice Carnahan has just completed a year as chairman of CACHE (the national committee on computer aids for chemical engineering education). Formed in 1971, its 18 members include three of our alumni: Larry Evans (Ph.D. 1962, now at MIT), Warren Seider (Ph.D. 1966, now at Pennsylvania), and Gary Powers (B.S.E. 1967, now at Carnegie-Mellon). Joe Martin has completed a two-year term as president of the Engineers Joint Council, and in November he served at Oklahoma State as the Phillips Petroleum Lecturer in Chemical Engineering Education. Ed Young recently stepped up to the chairmanship of the Michigan State Board of Registration for Professional Engineers. In April, Don Katz received the E.V. Murphree Award at the ACS Meeting in Philadelphia, in recognition of his fundamental research in engineering and its application to industrial processes. Brymer Williams was honored with the 1974 Stephen S. Attwood Distinguished Engineering Achievement Award, the highest award in the College of Engineering.

This year the fifth D.L. Katz Lectureship was awarded to Riki Kobayashi (Ph.D., U-M, 1953). The dinner afterwards was attended by five of the seven authors of the *Handbook of Natural Gas Engineering*: Katz, Kobayashi, Fred Pottmann (Sc.D. 1946, now with Marathon Oil), and two persons from Michigan Consolidated Gas—Jack Elenbaas (B.S.E. 1944) and John Vary.

Staff. Two of our very popular staff members retired during the year—Madge Ingerson and Connie Lacy. Mrs. Ingerson joined the former Chem/Met Department as an accountant in 1951, and she proved for more effective than deans in getting department chairmen to toe the line. A special Chem/Met dinner

was held in her honor at the Michigan League in January; the large turnout and the number of congratulatory letters from alumni attest to the large circle of friends she built up while here. Mrs. Lacy, secretary of the graduate office since 1970, was an endless source of willing assistance and cheerfulness to graduate students and faculty members.

Non-academic and sub-professional activities. For the first time since 1971, a joint Chem/Met graduate-student/faculty picnic was held, at the house of chairman Jim and Mary Ann Wilkes; it was so successful there may never be another. At 4 AM the host had to double as taxi driver owing to the breakdown of a celebrated faculty member's celebrated sports car. Just before the picnic, the chairman had an organ (suitable for a large church) installed in his house; friends immediately rose to the occasion by adorning his office door with a sign reading: "Organist for Hire; Weddings and Funerals Conducted with Decorum and Taste."



Faculty (F)/graduate student (S) bridge teams, Chelsea, 1975. Robert Kadlec (F), James Wilkes (F), Kasper Lund (S), James Hand (F), William Talbott (S), Robert Griffiths (S), Peter Parker (S), and Brice Carnahan (F).

Two more graduate-student/faculty bridge matches were held during the year. The net score over the past three years has now risen to 6–0 in favor of the Good Guys; it is rumored that some students are postponing graduation just to get in another crack or two at the faculty.



Madeleine ("Madge") Ingerson, on 24 April 1980, four years after her retirement.



James O. Wilkes, outside his office in 2028 East Engineering, the day after he had purchased a large electronic organ for his home.

Alumni support. We thank alumni and industry for their support during the year; the majority of funds received have been channeled into undergraduate scholarships and first year graduate-student fellowships. A new fund was established during the year; it is the Chemical Engineering Alumni/Faculty Merit

Scholarship Fund for support of deserving undergraduates. The A.H. White Fund also continues for chemical and materials and metallurgical transfer-student scholarships, as well as for student loans.

A memorable 18 inches of snow that fell on Ann Arbor early in December 1974 prevented several of us from attending the Washington AIChE meeting; therefore we especially looked forward to greeting alumni at the Los Angeles meeting the following November.

TechniUM—Fall 1976

The most important news of the year is the Capital Campaign gift of \$5.5 million towards the construction of a new Chemical and Materials & Metallurgical Engineering Building. To be named the Herbert H. Dow Building, in honor of the founder of the Dow Chemical Company, it will be constructed with the help of grants from two major Michigan foundations: \$4 million from the Herbert H. & Grace A. Dow Foundation, and \$1.5 million from the Harry A. & Margaret D. Towsley Foundation. (Mrs. Towsley is the daughter of Herbert H. Dow.) To these foundations and to individuals who have contributed (see *alumni support* below), we offer our sincere thanks for bringing us so much closer to the final move to North Campus.



Bob Kalmbach

Architect's sketch of the proposed H.H. Dow Building on the North Campus.

Like other chemical engineering departments, our undergraduate enrollment is increasing very rapidly. Enrollment in ChE 230, traditionally about 80, has jumped to 180 in two years, and there is no sign of abatement—nor, fortunately, of any further increase beyond this figure. We are doing our best to accommodate

the increase, which will strain our resources. During 1975–1976, we had more women students (40) than any other department in the college.

Student activities. Our students continue to distinguish themselves. Competing throughout the college, J.A. McKeen received the Andrew A. Kucher Award for undergraduate research, and R.L. Peterson (president of the AIChE Student Chapter) was named the most outstanding senior. At the national level, J.C. Lievens was selected for a Beinecke Memorial Scholarship, and R.A. Rykowski received honorable mention in the AIChE student design problem contest.

Our student chapter undertook the major effort of hosting the 26th Annual Conference of AIChE Student Chapters (North Central Region), held in Ann Arbor on 2–3 April. Sessions were held on the fluorocarbon/ozone controversy, toxic substances, nuclear energy, and coal gasification and natural gas. Each session featured speakers and panel discussions, with participants representing industry, government, students, and faculty. The whole event was highly successful, attracting almost 100 students from 12 other universities, plus a good contingent from our own department. As a result of successful fund-raising activities, the student chapter has made a contribution to the college's capital campaign, to be used for student-chapter facilities in the new Herbert H. Dow Building.

We congratulate the graduate-student duplicate bridge team (Bob Griffiths, Prem Gupta, Gerald Holder, and John Schoch) on their accomplishment of the seemingly impossible: victory over the ChE faculty! Having demonstrated that they have now scaled the ultimate pinnacle in their studies, we can safely expect all of them to graduate in the near future.

Research. Recently completed doctoral dissertations show the wide range of research interests in the department. In biochemical engineering, W.B. Woods (working with Lloyd Kempe) has shown that the movement of fermentation gases up fissures can significantly enhance the translocation of nutrients (such as phosphates) from lake sediments to the overlying body of water. In electrochemical engineering, D.J. Stover (with Frank Donahue) has brought basic ChE concepts to bear in the design, performance, and optimization of electrochemical cells; his studies have necessarily concentrated on the processes at the electrode/solution interfaces.

In computing, S.P. Singh (with Brice Carnahan) has developed an interactive computing system that allows a chemical engineer to draw and modify chemical-process flow sheets using a light pen as the input device to the screen of a graphical terminal; the flow sheet and other process information (entered graphically or through a terminal keyboard) is then supplied to a general process-simulation program (PACER in this case) running on the U–M Amdahl computer; both printed and graphical results are produced for the designer. In hydrocarbon phase behavior, D.F. Bergman (with Don Katz) has developed a reliable method for predicting the formation or absence of condensates in natural gas pipelines; a related

monograph, *Retrograde Condensation in Natural Gas Pipelines*, sponsored by the American Gas Association, has been prepared by Bergman, Tek, and Katz.

Our long-standing interest in energy-related research has been strengthened by two recently initiated projects. First, Arvids Judzis (working with Brymer Williams) is investigating the interaction of microwave radiation with oil shale. The initial objective, to develop a convenient assaying procedure, will involve an understanding of the mechanics of the interaction of microwave radiation with kerogen and related organic materials in an inorganic matrix. A second objective is to investigate the microwave irradiation as a potential method for the economic recovery of hydrocarbons from oil shale. Second, D.V. Addington (working with Dale Briggs) is studying the adsorption and/or electrokinetic precipitation of asphaltene sols derived from coal. The objective is to determine the mechanism of asphaltene deposition during filtration of liquefied coal through filter precoat and filter cakes, and to determine the role of asphaltenes in catalyst deactivation.



Donald L. Katz with the 1976 D.L. Katz Lecturer—Cedomir M. Sliepcevic (University of Oklahoma), 18 March 1976.

In the biomedical field, Jerry Schultz and Joe Goddard have collaborated in a joint project with Dr. S.M. Lindenauer (U–M Surgery Department) and Dr. J.A. Powers (U–M Hematology Department). Under the sponsorship of the National Heart & Lung Institute, they have developed a new procedure for evaluating the compatibility of blood with materials that could potentially be used in artificial organs, such as heart/lung machines and artificial kidneys.

Faculty. We regretfully announce the deaths of two emeritus professors—Brier and Brownell.†

† Biographies of both appear in Chapter 6.

In March we had the pleasure of a visit from Cedomir M. Sliepcevich, a former faculty member and now George Lynn Cross Research Professor at the University of Oklahoma. “Cheddy” was this year’s recipient of the D.L. Katz Lectureship, and discussed his research in a paper on “The Ignition and Burning of Solids.”

After 13 years at the U–M, Joe D. Goddard has left our faculty to accept a professorship and chair in chemical engineering at the University of Southern California. Joe is well known for his research and publications in fluid mechanics, particularly in the area of polymer rheology; we offer him our best wishes in his new position.

Rasin Tek has been on sabbatical leave at the University of New South Wales, Sydney, where he has taught two graduate courses, *Oil & Gas Engineering* and *Energy, Environment, and Fossil Fuels*. He reports that the competition in Australia is “very tough” (referring to tennis, of course). Rasin made an unprecedented 12,000-mile dash back to the Michigan/Ohio State game last November 22, but, alas, failed to cheer loudly enough—the score was Michigan 14, Ohio State 21.

Bob Kadlec succeeds Bob Reid (MIT) as editor of the *AIChE Journal*; we are very happy that the editorial office will reside in our department, but we trust that Bob will be sending most of his manuscripts elsewhere for review. Two of our faculty members are active participants in the national CACHE Committee (computer aids for ChEs): Scott Fogler has been elected a trustee, and Brice Carnahan continues as chairman of its Publications Committee.

If there were such an office as Speaker of the U–M, it would now be held by Brymer Williams, recently elected chairman of SACUA (Senate Advisory Committee on University Affairs, the nine-member executive committee of the U–M faculty government). Brymer has been a long-standing protector of protocol, and we wish him a comfortable, if not cushy, year as he sits on the woosack.

Giuseppe Parravano was honored by being named a Fulbright lecturer and research scholar, to participate in the educational exchange program between the U.S.A. and Austria. He spent the first six months of 1976 at the Institute of Physical Chemistry in Innsbruck, performing research on the applications of infrared spectroscopy to catalytic and reacting surfaces.

Ed Young was elected a fellow of the AIChE and also received the 1976 Engineer of the Year Award from the Michigan Society of Professional Engineers. He has continued to serve as chairman of the Michigan State Board of Registration for Professional Engineers. Incidentally, Ed Young and Frank Donahue are now continuing the course *Corrosion of Metals and Alloys* (ChE/MM 573) that was taught for many years by Clarence Siebert before his retirement.

Alumni support. We again thank alumni and industry for their support. Mrs. Theodore C. Argue of Kettering, Ohio, has kindly financed a scholarship in chemical engineering in memory of her late husband. Theodore Argue graduated from the department in 1935, and, except for five years in the army during the war,

spent a lifetime career in the rubber industry. His most recent position was that of technical director with the Rahco Rubber Company in Chicago. We appreciate the thoughtfulness of his wife and family in their support of our students.

The department has received the magnificent gift of \$100,000 from Dr. Walter J. Podbielniak, who obtained his Ph.D. here in 1928. The low-temperature fractionation process developed during his research at Michigan marked the beginning of a highly inventive and successful industrial career. From 1928–1938, he was in private business, but had a firmly established company, W.J. Podbielniak, Inc. in Chicago, as of 1938. He is known mainly for his invention, perfection, and production of two important industrial devices. The first is the low-temperature Podbielniak fractionating column, which, in its earlier days, was the only practical method for analyzing samples of natural gas and gasoline. The second is the Podbielniak centrifugal contractor, now used extensively for a wide variety of solvent-extraction operations that need short contact times and low solvent inventories. Also, an early invention of his centered on the use of fluid mixtures for refrigerants; in this instance, his foresight anticipated industrial needs by some 30 years, and his basic idea is now used for the large-scale liquefaction of natural gas. Our gratitude goes to Dr. Podbielniak and his wife Nancy, who live in Rancho Santa Fe, California, for their kindness and generosity.

TechniUM—Winter 1977-1978

The Winter 1977–1978 *TechniUM* was a special chemical engineering alumni issue, and included the following statement from Jim Wilkes:

“After six years as department chairman, I confidently turn over the position to Jerry Schultz and return full time to my teaching, research, and writing activities. The 1970s have seen significant changes in higher education generally, and in our department in particular. In six years, our real budget has declined by about 25%, and our student body has doubled (including more women than any other department in the college); that is, our appropriations per student are now about 40% of what they were in 1971. These factors have made the job of guiding a department a stimulating yet discomfoting experience—evidenced, perhaps, by the fact that at the end of my stint as chairman, I had become (with one exception) the most senior of the twelve departmental chairmen in the college. I appreciate the interest and support that you, the alumni, have given the department during my tenure as chairman, and know that your continuing support will be very important to Jerry in the coming years.”

TechniUM also contained the following seven snapshots of selected research projects conducted by our faculty during the mid-1970s. The drawings of the faculty are taken from our 1978 *Graduate Booklet*.

Tertiary Treatment of Sewage in Wetlands (Robert H. Kadlec)*Robert Kadlec*

Under the 1972 Water Pollution Control Act, communities are supposed to be currently upgrading their sewage treatment from primary to secondary levels. By the mid-1980s they will be expected to provide tertiary treatment for sewage before dumping it back into the ecosystem. Our research (conducted in conjunction with the Williams and Works firm in Grand Rapids, Michigan) shows that secondarily treated sewage may be dumped into certain kinds of wetlands with virtually no adverse ecological impact. The “laboratory” for this work is a marsh located near Houghton Lake, Michigan. In 1971, the Houghton Lake Area Sewer Authority asked the state for permission to dump its effluent into the nearby peat bog marsh. Approval was granted after our group was engaged to monitor

ecological impact. So far, there has been no contamination problem. The level of fecal coliform bacteria that the sewage brings into the marshland is roughly equivalent to the level of fecal coliform already there, and is easily absorbed into the ecosystem.

Not all communities will be able to use a marsh to meet the mid-1980s law. On a population basis, not much of the country lives near wetlands, nor would there be enough wetlands to deal with a large fraction of the populations. However, on a geographic basis there is a fantastic opportunity for small communities, which occupy a large part of our geography, to take advantage of the results of these experiments.

High-Temperature Short-Time Sterilization (Lloyd L. Kempe)

Commercial sterilization of foods, fermentation media, and pharmaceuticals is usually a batch process using saturated steam at about 240 °F. In recent years, liquids such as milk, soup, antibiotic-production media, heat-sensitive medicines, and baby foods have been sterilized by a continuous process that has been variously called (a) flash sterilization, (b) ultra-high temperature (UHT), or (c) high-temperature, short-time (HTST) sterilization. With this last process, temperatures as high as 280 °F are used. HTST sterilization has the advantage of being a continuous process, which sterilizes with little heat damage. For instance, milk can be sterilized (not just pasteurized) and still retain most of its original organoleptic and nutritional characteristics. A limitation of HTST sterilization is that not enough is known about the basic thermal conductivities of anything but isotropic

fluids; “chunky” soups or fermentation media containing soy or other particles are not sterilized using HTST procedures because of this lack of information.

We are presently correlating experimentally determined heat-penetration data with a computer program. Success in the undertaking will mean a greatly expanded use of HTST sterilization procedures in industry.



Lloyd Kempe

To measure temperature penetration, a roll of chromatography paper is sterilized in an autoclave. The roll is then saturated in a sterile broth, and finally, aseptically inoculated at its center with *bacillus subtilis* 5230. The inoculated rolls are then placed in thermal-processing tubes and the tubes immersed in an ethylene glycol heating bath with a temperature ranging up to 270 °F. The treated rolls are incubated, and bacterial growth confirmed by turbidity. Results so far underline the need to monitor the internal temperatures of particles, and not the temperature of the immersion bath. A dramatic difference can exist between the bath temperature and the interior particles, even with significant exposure times.

Acidization of Porous Media (H. Scott Fogler)



Scott Fogler

Drilling a hole in the ground is only a marginally efficient way of bringing oil to the surface. For many years, the productivity of wells—oil, water, and geothermal—has been improved by injecting acids into them. The acids selectively dissolve some of the earth surrounding the well bore and improve the porosity and permeability. Until now, an understanding of the process has been based on empirical engineering data. We believe that more sophisticated solvents can be used to improve well production if a clearer understanding is developed about the acidization process in porous media. An ultimate goal would be a catalog of rock formations with optimal compounds for the selective dissolution of their components.

Of course, interest focuses on the chemistry of oil-bearing media. There are two main classes of minerals found in oil-producing formations: carbonates, primarily calcium carbonate and calcium-magnesium carbonate; and silicates, typically quartz, feldspar, and clay. The carbonates are dissolved with HCl, and the

silicates with a mixture of HCl and HF. HCl has no effect on silicates by itself, but is a catalyst for the HF. About two-thirds of the world's petroleum reserves are in silicate sandstone structures, so there is natural interest in the improved acidization of silicates.

We have discovered that the HF dissolution of some silicates is catalyzed by some salts and weak acids. The rate laws vary from system to system; currently, we are investigating why ammonium chloride catalyzes the dissolution of kaolinite to a greater extent than ammonium nitrate.

In an effort to understand the process clearly, we are working on a mathematical model for the acidization of porous media. Such a model, and the knowledge it contains, would go a long way towards unlocking all the oil reserves that are accessible to us.

Characterizing Liquefied Coal (Dale E. Briggs)



Dale Briggs

In order to design efficient coal-liquefaction plants, more needs to be known about the characteristics of liquefied coal. One approach is to find synthetic compounds that act just like liquefied coal; in discovering these compounds, we may verify the characteristics of the liquefied coal itself. The synthetic compounds we have selected initially are four bis-(hydroxyphenyl) alkanes, and four α, ω -dipyridyl or diquinonyl alkanes. Data about liquefied coal have been developed using the analytical tests itemized below. Later, the same tests will be applied to the synthetic compounds and the results compared with the baseline data for the coal.

1. Solvent-extracted asphaltenes from an H-coal liquefaction of an Illinois No. 6 coal were fractionated in a gel-chromatography column. Fractions were characterized by molecular weight, elemental, and proton NMR analyses. Oxygen and metal levels were determined by neutron activation. Exploratory experiments are underway to separate asphaltenes into acidic and basic fractions, and to correlate the physical and chemical properties of these coal derivatives.
2. Filtration data were collected at 232 °C for different concentrations of oils, resins, asphaltenes, and preasphaltenes with 13.8 wt% THF insoluble solids. It was found that at comparable asphaltene and preasphaltene concentrations, the specific cake resistance is less with oils and resin than with tetralin. Also, the colloid micelles that form in tetralin at about 16–18% asphaltenes at 177 °C are substantially peptized by resins.

3. Electrophoresis produced a larger deposit on the positive electrode: it contained pyridine, THF, and *m*-cresol. The negative electrode deposit contained the solvents, benzene and tetralin. The amount of deposition can be used to indicate the extent of the asphaltene or preasphaltene solubilization: the greatest solubilization is in pyridine at elevated temperatures.
4. Adsorption studies showed that micelle formation was apparent with the higher molecular weight asphaltene fractions, and the critical micelle concentration is temperature dependent.

Spectroscopy and Catalysis (Giuseppe Parravano)



Giuseppe Parravano

Although supported-metal catalysts of gold, platinum, and rutherfordium have been used in industry for more than three decades, the fundamental mechanism for their high catalytic activity and selectivity is still largely unsolved. Our studies concern the structure, properties, and reactivity of supported-metal catalysts, especially bimetallic preparations. We are interested in the characterization of particle size, shape/size distribution, surface composition (for binary preparations), and structure. Our purpose is to develop a fairly detailed atomic model of the electron orbital surface structure and relate the information to preparative and operative conditions and effects. The investigative tools used include Mössbauer spectroscopy (surface and sub-surface composition), extended x-ray fine-structure

absorption spectroscopy (radial structure function), Auger electron spectroscopy (surface composition), transmission electron microscopy (particle size and size distribution), electron spectroscopy for chemical analysis (electron binding energy), and infrared spectroscopy (surface species).

Kinetic tools have been developed for studying the catalytic reaction itself. For example, isotopic exchange is being used to measure the rate of the individual reaction steps in the reduction of NO.

Biomaterials (Jerome S. Schultz)

Physicians are always inserting things into human bloodstreams—sometimes for years, in the case of prosthetic heart valves or embedded hookups for kidney dialysis. Our work is an interdepartmental study of the suitability of materials for use within the veins and arteries. A device has been designed which provides access to a dog's vascular system, and includes a blood-flow chamber into which materials can be introduced for the study of clot formation.



Jerome Schultz

The device is connected to tubes that are surgically implanted and form a loop connecting the major cervical artery directly to the major vein; the volume-flow of blood provided is nearly equal to that produced by the heart. A chamber in the loop contains a rotating shaft onto which biomaterials can be placed for testing. So far, this chamber has been used primarily to compare biomaterials for “thrombogenicity,” or the tendency to encourage the formation of stationary clots. To conduct a test, the chamber is prepared by coating the rotating shaft with a biomaterial. The variable shaft speed determines shear parameters and the effective rate of blood flow. The actual blood flow is maintained at a constant rate and monitored ultrasonically by a Doppler flow meter.

With the chamber connected, the dog is injected with radioactively-labeled fibrinogen and platelets, which are essential for clotting. As the test proceeds, and a clot forms on the rotating shaft, the buildup can be monitored by measuring its radioactivity. At the end of the test period, the clotted material can be removed and analyzed for fibrinogens, platelets, weight, water content, and blood cells.

Results of tests so far have shown that silicone rubber is less thrombogenic than stainless steel. In addition, it appears that the surface of the test material dramatically affects the structure of the clot, and the introduction of drugs has a direct impact on the rate and type of clot formation.

Additional work with the chamber will focus on the study of blood dynamics in such diseases as atherosclerosis and phlebitis.

Polymer Laboratory (James H. Hand)

Our refurbished polymer laboratory† now provides students with first-hand knowledge of process conditions that are typical in industry. Studies in the laboratory center on the synthesis and characterization of macromolecules and processing, and the mechanical testing of melts and solids. The laboratory is used for undergraduate and graduate courses, as well as research. With the equipment in the laboratory, polymer production can be followed from monomers to the finished product. Currently, 60 students are enrolled in the senior/graduate introductory course—the maximum number that the laboratory can accommodate. Enrollment had to be curtailed early because of space limitations. Students in the laboratory

† Thanks to the generosity of alumnus “Doc” (Charles A.) Lunn.

represent several departments: the Chemical Engineering, Materials & Metallurgical Engineering, and Mechanical Engineering Departments are the three with the largest representations.



James Hand

Research in the laboratory is varied. Gregory Yeh and Frank Filisko from the Materials and Metallurgical Engineering Department are studying the relationships between processing, supramolecular structure, and the mechanical properties of polymer systems. Their approach to structure determination involves the use of a precision microcalorimeter to measure nearly infinitesimal heat releases when ordered structures in processed polymers are dissolved. In addition, Filisko is involved in the development of new biomaterials, primarily for use in facial reconstruction procedures. Yeh is working on a full understanding of the processing of transparent, semi-crystalline polymers. He is also interested in glassy carbon structure/property relations, deformation behavior, and the effects of radiation on

polymers.

Part of my research centers on the development of biomaterials for orthopedic devices. The new materials include interpenetrating-network composites of glassy carbon and polymer, and ceramic and polymer. These composites could be used for the construction of implantable hip and knee joints. Along with this development, we are working on new formulations for acrylic cements, which can be used to join metal prostheses to bone. Another area of investigation has shown that small amounts of polymer (1,000 parts per million of hydroxyethylcellulose) enhance the heat flux in pool boiling of water by a factor of ten.

Chapter 10

1977–2002, INCLUDING THE MOVE TO NORTH CAMPUS

THE major event in the most recent 25 years of our history was our move to North Campus, vacating East Engineering after 59 years. We therefore start this chapter by discussing the construction, dedication, and occupation of our new facilities. Thereafter, we recall departmental events during the tenures of our five chairmen during this period—Prof. Schultz, Fogler, Schwank, Yang, and Larson.

The Herbert H. Dow Building

Our department moved into the new Herbert H. Dow Building on the U–M North Campus during the summer of 1982. Designed by the architectural firm Alden B. Dow Associates, Inc., the three-story structure is faced with light red brick and contains 115,000 square feet of space.



James Wilkes

The approach from the northwest to the H.H. Dow Building, July 2000.

Initially, we occupied all of the third floor and shared part of the second floor with the then Materials & Metallurgical Engineering Department (M&ME). Only

about one third of the first floor was finished and was devoted to classrooms. A few years later, we acquired more space in the new “Dow Connector” Building (joining us to the G.G. Brown Building to the east) and the second floor became completely occupied by M&ME. The remaining two-thirds of the first floor were also completely excavated and finished, and were initially allocated to the Engineering Library (the mezzanine of which housed part of the CAEN laboratories), instructional television, and freshman computing classrooms and laboratories (designed and managed by Profs. Carnahan and Wilkes).



James Wilkes

The Herbert H. Dow Building from the north, with the Ann and Robert H. Lurie Tower in the background. July 2000.

The Herbert H. Dow Building was made possible through gifts of \$4 million from the Herbert H. and Grace A. Dow Foundation of Midland and \$1.5 million from the Harry A. and Margaret D. Towsley Foundation of Ann Arbor, as well as gifts from other private contributors during the College of Engineering’s \$20-million capital campaign, chaired by alumnus James E. Knott, and which ended in November 1978. At the time, the combined gifts were the largest ever made to the college, and one of the largest foundation gifts in the university’s history. The total cost of the building was \$10.5 million.

Dedication ceremonies for the Herbert H. Dow Building on the U–M North Campus were held on Friday, 15 April 1983, starting in the Chrysler Center Auditorium. There followed a reception, open house, and guided tours of the Dow Building, whose street designation is 2300 Hayward Drive, Ann Arbor, MI 48109–2136.

Dedication Program, 2:00 PM, 15 April 1983

Presiding President Harold T. Shapiro
Introduction of Distinguished Guests President Shapiro
Presentation of the Herbert H. Dow Building
..... Dr. Harry A. Towsley
Acceptance of the Building for the University
..... President Shapiro
Acceptance of the Building for the College
..... Dean James J. Duderstadt
..... Engineering Council President Jody Van De Polder
Unveiling of the Plaque Margaret Ann Towsley Riecker
Closing Remarks President Shapiro



James Wilkes

Part of the crowd assembled for ground-breaking for the Herbert H. Dow Building, May 1980. Donald Katz (with his hand on a chair) stands on the right.

Dean Duderstadt said: “The Dow Building is the cornerstone of the college’s long-awaited move to the North Campus. It provides students and faculty with outstanding facilities for instruction and research in the critical areas of chemical, metallurgical, and materials engineering. The new building also provides a vivid demonstration of the importance of private support in determining the university’s ability to respond to the needs of the state and the nation for technological

innovation and of the talented, broadly educated engineers who will apply such technology.”



James Wilkes

Dr. Harry A. Towsley (R) digs the proverbial first shovelful of dirt for the H.H. Dow Building, under the scrutiny of Dean David Ragone, May 1980.



James Wilkes

The Herbert H. Dow Building, from the southwest, May 2000. The white metal sculpture by Alice Aycock, “Summaries of arithmetic through dust, including writing not yet printed,” was presented to the College of Engineering in 1992 by the Class of ’32E.

In addition to the college's administrative offices, which had moved into the Chrysler Center in fall 1982, four other disciplines preceded our move to the North Campus: aerospace engineering, atmospheric and oceanic science, naval architecture and marine engineering, and nuclear engineering.



Appleton-Century-Crofts, Inc.

Herbert Henry Dow in 1897, the year in which he founded his company.

Our North Campus home is named after Herbert Henry Dow (1866–1930), who founded the Dow Chemical Company in Midland, Michigan, in 1897. His biography has been written by Murray Campbell and Harrison Hatton in their book *Herbert H. Dow, Pioneer in Creative Chemistry*, Appleton-Century-Crofts, Inc., New York, 1951. Further information about his company is available in Don Whitehead's *The Dow Story—The History of the Dow Chemical Company*, McGraw-Hill, New York, 1968.

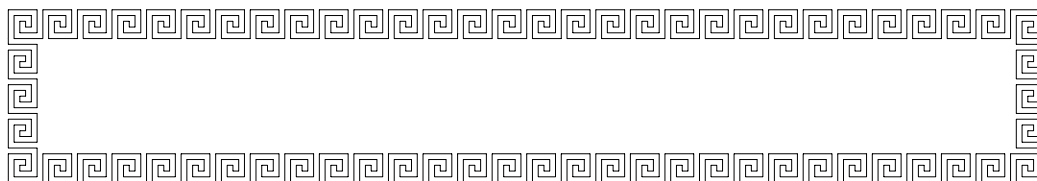

JEROME S. SCHULTZ**Chairman, 1977–1985**

PROFESSOR Jerome (“Jerry”) S. Schultz joined the department in 1963, after spending six years as a group leader in biochemical research at American Cyanamid. His doctorate is in biochemistry from Wisconsin, following a B.S. and M.S. in chemical engineering from Columbia University.

At the University of Michigan, Jerry was heavily involved in biochemical and biomedical engineering, and from 1971–1976 was honored with a full fellowship award from the National Institute of Health. His research has taken him into transport mechanisms in membranes, diffusion in biological tissues, enzymes, microbial growth, and blood clotting on biomaterials. After stepping down from the chairmanship in 1985, he spent some time at the National Science Foundation, leaving us in 1987 for the University of Pittsburgh, where he became chief scientist and director of the Center for Biotechnology and Bioengineering. Jerry has written the following reflections on departmental events during his chairmanship.

“As I entered the chairmanship in 1977, there were a number of factors of concern that affected the stature and performance of the Department of Chemical Engineering. One mixed blessing was the increased undergraduate enrollment in chemical engineering. Over the previous five years, the number of students increased from 150 to 320. Effectively dealing with this increase required a rethinking of our undergraduate curriculum and teaching methods. The research activities of our department were also impacted, given the increased amount of effort needed to be devoted to undergraduates. Further, our research agenda was dominated by our departmental “stars” of the last two generations—Donald Katz, Jack Powers, Stuart Churchill, etc., who made their impact on the profession through the emphasis on unit operations. Moreover, I believe that although it was strongly favored by Lawrence Van Vlack, the separation of the Department of Chemical and Metallurgical Engineering into two units damaged the potential of the remaining chemical engineering unit. The metallurgical and material science faculty could have provided an excellent group of colleagues with a very strong science influence on the chemical engineering program. About this time, the trend towards engineering science had become pervasive in the field, typified by books such as the University of Wisconsin’s *Transport Phenomena*, written by Bird, Stewart, and Lightfoot, the emergence of mathematical analysis as exemplified by the University of Minnesota’s Aris and Amundson, and the coming to maturity of *Chemical Engineering Science* as a major journal of the field. So I considered it essential to establish a new thrust for chemical engineering at Michigan that would depart from our previous concentration in unit operations.

From my vantage point, it appeared that chemical engineering in general had lost its basic *raison d’être*, that is, chemistry. One might recall that the leading journal of our profession, *Industrial and Engineering Chemistry*, used to have

annual reviews in unit operations and, importantly, unit processes. The latter focused on the chemical aspects of chemical engineering. My sense of science in the late 1970s was that it was moving from a descriptive mode to a mechanistic mode. The power of new tools like the scanning electron microscope, spectroscopic techniques like FTIR, and the breaking of the genetic code made it clear that chemical engineering would be entering a new era of development where the focus would be on the molecular level. So I decided to redirect our department to change its focus from the industrial plant-scale side of chemical engineering, as embodied in the unit operations to the “micro” aspect of chemistry, or—to put it another way—from “macro-engineering” to “molecular-engineering.”

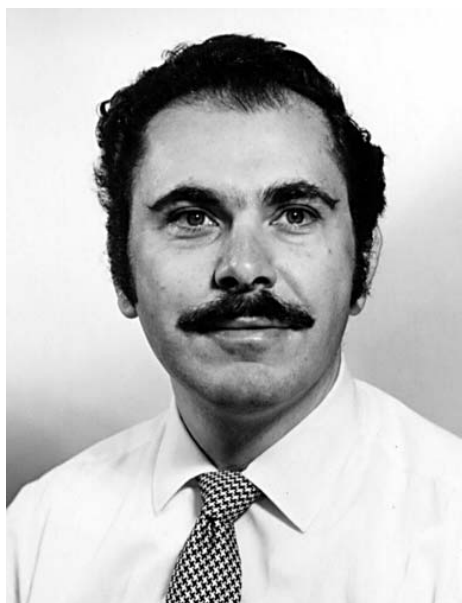

Jerome S. Schultz.

Another trend was taking place in the demand for chemical engineers in industry. For many years the petroleum industry dominated the character of the educational programs for chemical engineers. We tended to concentrate on liquid systems since refineries were primarily fluid-based, continuous processing plants. Yet employment opportunities in the petroleum industry were diminishing because of the movement to off-shore installations. Thus, there was a need to broaden the educational experience to prepare our students better for the diverse nature of potential industrial opportunities, e.g. polymers, environment, food, and pharmaceutical industries.

A fortunate opportunity arose for the Department of Chemical Engineering with Dean Ragone’s decision to reinvigorate the North Campus as the site for the College of Engineering with the initiation of a new building. Ragone was

able to raise the required funding from the Dow and Towsley Foundations. An interesting sidelight is that one of the stipulations for the gift was that a Dow family architect should be given the contract for designing the building. It turned out that this architectural firm had never designed a laboratory building before. So I spent many hours with them assisting with the technical specifications of hoods, laboratory benches, and utility needs, etc.

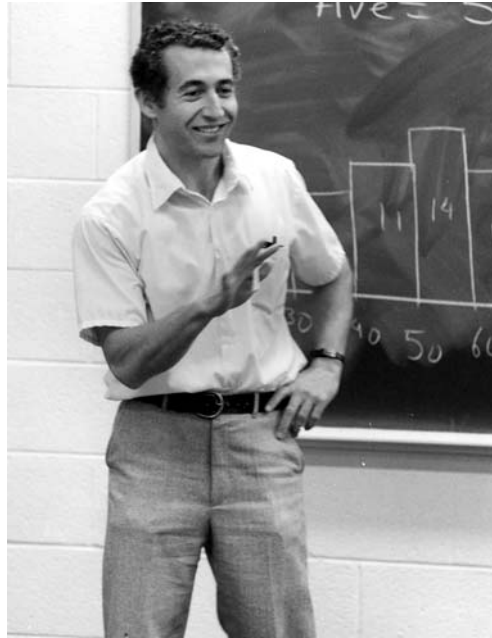

Bob Kalmbach

Erdogan Gulari, who joined us during Prof. Schultz's tenure. Photo taken in spring 1984.

One of the challenges for the department was the increased teaching load due to the doubling in the undergraduate enrollment. Part of this expenditure in faculty effort was due to resource allocation formula that was used by Dean Ragone that gave departments a budget related to the number of courses that the department taught. So we were in a mode of having 20–30 students per class and offering all the required undergraduate courses each term. However, I felt that it was more important for the department to provide faculty with more time for research. So we changed our teaching style to have larger classes and to reduce the duplication of courses during the year. This was an important consideration in the design of the Dow Building, where we wanted to insure that we had a large enough lecture hall so that we could handle the entire group of students in each undergraduate class in one room.

We embarked on a plan to hire new faculty with strong research interests in

the basic sciences, particularly at the molecular and atomic level. Faculty who joined us during this period who provided the molecular engineering character to the department were Erdogan Gulari, who was essentially trained as a physical chemist; Johannes Schwank, who had strong interests in surface chemistry; Henry Wang, who was an applied microbiologist; Bernhard Palsson, a chemical engineer with interests in molecular biology; and Robert Ziff, a physicist with an interest in statistical mechanics. With these faculty we completely renovated our laboratory capabilities. Some of our research facilities included specially equipped laboratories for research in catalysis, polymers, solid/liquid reactions, sonochemistry, electrochemical engineering, petroleum, bioengineering, industrial microbiology, ecological systems, coal liquefaction, colloidal phenomena, and computation and simulation.



Jerome S. Schultz with his light-scattering instrumentation that was used to determine the effects of shear on the kinetics of fibrin aggregation. This was one aspect of his NIH-supported project to develop a fundamental understanding of blood coagulation in devices such as artificial kidneys and heart-assist pumps.

My recollection is that our department became populated with all sorts of analytical equipment—lasers, spectrometers, surface-analysis equipment, microscopes, chromatographs, electrophoresis set-ups, atomic-adsorption spectrometers, potentiostats, osmometer, x-ray spectrograph, goniometer, FTIR spectrometer, light-scattering spectrometer, particle-size analyzers, Coulter counter, and so on. Of course we continued our dominance in the College of Engineering in instructional computer methodologies that was started by Don Katz and continued by Brice

Carnahan and James Wilkes. One of the pleasant tasks during my chairmanship was to organize the nomination of Don Katz for the Presidential Medal of Science. We were all proud and pleased when Don was selected for this honor by President Reagan, and my wife Jane and I were particularly thrilled when Don invited us to join his family for the award presentation ceremony at the White House.

During my tenure as chairman I felt that it was important to stimulate research in the department. One way to lead the department in this direction was by example. So in addition to my other duties, I put in an extra effort in my own research program to provide the faculty with an example that it could be done. I applied for several research grants myself and was fortunate to obtain a number of these with a total value of over \$2,000,000. With the outstanding graduate students we were able to attract to the department I was able to carry out advanced research in membranes, pharmacokinetics, biomaterials, and biosensors, which eventually led to my being selected into the National Academy of Engineering.

I also encouraged our industrial friends to increase their support of the department. All this pressure resulted in a major increase in the research funding to the department. The *Gorman Report* ranked both our undergraduate and graduate programs ninth nationally and fifth among state universities. We also enlarged and modernized our support staff with individuals with expertise in instrumentation and computer programming. In our departmental brochure in the mid-1980s we acknowledge about 50 institutions who were providing financial support to the department. Valerie Franklin was hired to provide faculty with administrative support for their research programs since the university accounting system was woefully slow. She also assisted in brightening up our new building by selecting artwork for our offices and conference rooms. The generation of assistance was sufficiently large that we were able to develop an endowment account for the department which gave us additional income due to the interest generated by these investments. At the end of my tenure as chairman in 1985, this account amounted to about \$500,000.”



H. SCOTT FOGLER**Chairman, 1985–1990**

BORN in Bloomington, Illinois, and raised in Chicago, Professor Scott Fogler attended the University of Illinois. When mentor Max Peters, head of the Chemical Engineering Department at the University of Illinois, took the position of dean at the University of Colorado, Fogler followed, earning his Ph.D. there under the tutelage of Klaus Timmerhaus.

Fogler joined the University of Michigan faculty in 1965, at which time his research focused on the effect of ultrasonic waves on chemical processing. As a result of consulting work for Chevron Oil Field Research Company in 1967, Fogler's research interests evolved to the study of flow and reaction in porous media, colloid stability, and dissolution kinetics in microelectronics fabrication. In 1984, Professor Fogler was appointed the Ame and Catherine Vennema Distinguished Professor of Chemical Engineering at the University of Michigan.



H. Scott Fogler.

Professor Fogler approached the chairmanship with energy reminiscent of Donald Katz. His immediate goal was a revitalization of research efforts, with emphasis on creativity and innovation. Improved instruction was a natural outgrowth of this effort. “If a person is a superior researcher, he or she will almost always be a great instructor, and vice versa,” he explains. “If the material continues to be exciting to the instructor, it will be that much more interesting to students.” Aware of the need for students to master the overwhelming wealth of chemical engineering knowledge, Fogler introduced “lifelong learning skills” to students, which includes

solving at least one open-ended problem in every undergraduate chemical engineering course.

While chairman, Fogler continued an ambitious research program, overseeing eight Ph.D. students, in addition to his administrative responsibilities. Though he had a reduced course load, teaching was always a priority. He said: “We achieve excellence by developing students so they become well polished professionals in their fields, able to distinguish the difference between a major breakthrough in research from a trivial extension of previous work. We want our students to grow to their potential: to learn how to advance the frontiers of science; to present their research clearly and professionally; and to defend their findings with confidence. The only way to achieve a number-one department is through collective creativity—the efforts of every faculty member helping each other and their students achieve their highest potential.”

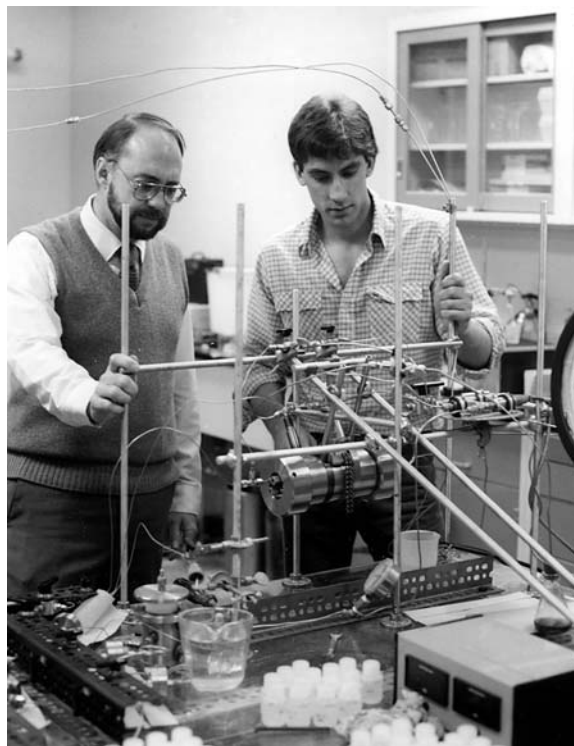

H. Scott Fogler and his graduate student Mark Hoefner.

Prof. Fogler started the tradition of recognizing our graduating doctoral students at the annual Donald L. Katz Lectureship dinner, and also of placing framed photographs of every graduating senior in the hallways of the H.H. Dow Building. Much of his time as chair went into recruiting the following new faculty members:

- Phillip Savage, University of Delaware.
- Jennifer Linderman, University of Pennsylvania.
- Stacy Bike, Carnegie Mellon University.
- Levi Thompson, University of Michigan.
- Mark Burns, University of Pennsylvania via University of Massachusetts.

It was also during Fogler’s term that the undergraduates began publishing their yearbook, *How to Succeed in Chemical Engineering*, which is still being produced every other year.



North Campus, from the southwest, ca. 1999. The H.H. Dow Building is immediately behind the Ann and Robert H. Lurie Tower, with the Pierpont Commons at lower left. Bonisteel Blvd. is in the foreground, and the North Campus “Diag” leads from the Media Union to the EECS and H.H. Dow Buildings.

In the *Michigan Engineer* for spring 1986, Fogler wrote the following about the new research directions he was overseeing.

“We have begun by consolidating certain research areas and making major improvements to the department’s research facilities; we have hired some outstanding new faculty; and we are applying new concepts to our teaching. During the next few years, one of the new directions will involve a greater emphasis on the formation of faculty research teams. Team members will collaborate on problems of mutual research interest by joint proposal writing and supervision of doctoral

students. Teams are already being formed to interact with companies on research problems in order to establish industry/university research partnerships.

An example of successful collaboration with industry is the Flow and Reaction in Porous Media Industrial Affiliates Program between the Chemical Engineering Department and Baker Petrolite, Chevron, Conoco, Halliburton, Phillips, Schlumberger, PDVSA–Intevep, and Total Fina Elf. In this program, research includes studying the effects of injecting acids into porous sandstones and limestones to improve the permeability of these types of reservoir formations, and understanding the mechanism of colloidally induced fines migration in porous media. This university/industry interaction and exchange of ideas has been invaluable in defining and solving problems of both scientific and industrial importance. This affiliates program has been in existence since 1984.

A program in biotechnology is currently under development with Professors Henry Wang, Bernhard Palsson, and Jerome Schultz as team members. The department will soon begin construction of a new quarter-million dollar cell-culture facility devoted to biotechnical research and development. Laboratory studies of recombinant DNA and cell-fusion technology suggest significant new possibilities for the production of pharmaceuticals, specialty chemicals, and monoclonal antibodies. However, to move these techniques from the laboratory into commercial production, a number of problems must be solved. Professor Wang, whose specialty is biotechnology, says that the new facility will be used to improve understanding of metabolic and subcellular processes and mechanisms, and to explore the monitoring and control aspects of large-scale cell culturing. Another faculty member is expected to be added to the biotechnology area next year.

Other new directions within the department include the continuous processing of semiconductor and composite materials and microelectronic devices, microseparation technology to remove trace toxins from wastewater, the purification of biologically important substances, and engineering problems facing the petroleum industry. The department is collaborating with other U–M research units, such as the Macromolecular Research Center of the Institute of Science and Technology, the School of Pharmacy, and the Chemistry Department.

As of 1986, the department's newest faculty members (all assistant professors) are:

- Bernhard Palsson, who completed his graduate work at the University of Wisconsin, and works in biochemical engineering and biotechnology processing.
- A.C. (“Tasos”) Papanastasiou, who earned his Ph.D. from the University of Minnesota. His research interests are in fluid mechanics, rheology, the processing of polymers, composite materials and microelectronic devices, computer-aided analysis of flows, and supercomputing.
- Robert Ziff, a Rockefeller University graduate in physics, who is developing computer techniques to help describe and predict the properties of polymers,

droplets, and smoke particles.

- Costas Kravaris, a California Institute of Technology graduate, is studying process control and the geophysics of oil and gas reservoirs.

The department currently has 17 faculty members and 60 graduate students and expects further growth in the near future. The addition of at least four new faculty is planned for the next two years, and the number of graduate students is expected to reach 100 by 1990.”

JOHANNES W. SCHWANK

Chairman, 1990–1995

BORN in Zams, a small village in western Austria, Johannes Schwank was first exposed to the worlds of science and industry by his father, a patents broker who arranged the financing and R&D for inventors who had an idea but lacked the resources to bring the invention to market.



Johannes W. Schwank.

Schwank earned both his diploma in chemistry and his Ph.D. in physical chemistry at the University of Innsbruck, whose faculty included renowned scholars such as Emeritus Professor Erika Cremer and Professor Hans Gruber. Gruber co-chaired Schwank’s dissertation committee along with another famous scholar then on sabbatical leave from the University of Michigan: Giuseppe Parravano. The latter’s influence steered Schwank’s research towards Parravano’s project, which focused on ruthenium and gold as catalytic materials.

Upon Parravano's invitation to Ann Arbor, Schwank earned a Fulbright postdoctoral fellowship for study in our department, for which he had always had a great respect and was an admirer of its glorious history. Sadly, only a month after Schwank arrived in the United States, in the spring of 1978, Giuseppe Parravano unexpectedly died. Yet despite this personal and professional blow, Schwank completed his postdoctoral research and went on to hold assistant, associate, and ultimately full professor positions in our department.

Schwank's strong connections to Michigan industry have bolstered his admiration for U–M as a premier research and teaching institution. "I could see the potential here," he said. "One of the major frontiers of my field—converter technology—was being tackled at Ford and General Motors. The GM Tech Center had a very strong group in catalysis. This was in the heyday of the development of catalytic-converter technology for automobiles. The Ford Research Laboratory also had a very fine group of scientists. It was intriguing for me to work in close proximity to these professionals whom I had read about and whose work I respected so much."

Professor Schwank foresaw exciting global opportunities for the department emerging from the historical intertwining of theoretical "pure" science with industrial applications. He believed that computer modeling, for example, would play a greater role in guiding experimental work. Applied to catalysis research, computer modeling "will give us much more sophisticated control over temperature profiles, reactor configurations, and gas interactions with catalytic surfaces," Schwank said. "The upshot of this will be a major change in the design of catalytic reactors."

Appointed to interim chairman in 1990, and chairman in March of 1991, Schwank has built on the great tradition established by his predecessors in office. Of his immediate predecessor, Schwank said: "Professor Fogler has created a very strong foundation by revolutionizing our undergraduate instruction. This process will enable us both to support our students and to provide outstanding chemical engineers for business, industry, and academia."

Schwank encouraged joint faculty research groups strategically clustered in areas such as bioengineering, polymers, design, and environmental research. He supported the development of textbooks-in-progress that would enhance Michigan's leadership role in the chemical engineering community. He was a firm believer that our department will continue to grow and thrive because of the ingredient that has always engineered its success—its people.

An idea of the research performed by our faculty during Schwank's tenure is given by the following excerpts from the 1996 booklet, *Graduate Studies in Chemical Engineering at the University of Michigan*.

Biotechnology and biomedical engineering. (Profs. Bike, Burns, Curl, Fogler, Linderman, Mooney, and Wang.) Modern biotechnology encompasses quantitative biology, cell and tissue engineering, biomolecular engineering, and

bioprocess technology. Research in modern biotechnology remains a focus of the department. Quantitative study of living cells at the molecular level allows engineering of cell function and form. The engineering of specific molecules to accomplish a biological effect is now possible. Tissue engineering integrates biomaterials and cellular elements to construct functional organs for medical use. A new frontier in bioprocess technology is the coupling of micromachining and microfabrication with current macroscale reaction and separation analysis systems. Just as the computer industry was revolutionized by silicon micromachining, bioelectronics and microanalysis have the potential to be transformed by advances in semiconductor and new material-processing techniques. The full potential of biotechnology will only be realized when: (1) biologists have brought the cellular component within the realm of engineering design, and (2) engineers have brought their methods of measurement, analysis, synthesis, and control within the realm of cell and molecular biology. The integration of these disciplines with their different histories, philosophies, and approaches will increase our basic understanding of how living cells and tissues function as integrated units and how we can exploit this understanding for human advancement.



Larime Photographic

North Campus, from the southeast, ca. 1999. The Herbert H. Dow Building is top center, with the EECS Building to the right and the Ann and Robert H. Lurie Tower and Media Union to the left.

Materials and polymer processing. (Profs. Bike, Gulari, Lastoskie, Mooney, Thompson, Wilkes, and Yang.) An important new research direction in the department is the processing and formulation of advanced, high-performance specialty materials. Processes under investigation include the leveling of non-

Newtonian paint films on plastic automobile body panels in the presence of heat transfer and solvent evaporation, the characterization of surface-layer morphology of injection-molded parts under conditions of simple and slip mold filling, and the rheological characterization of water-borne coatings and ceramic-filled polymer melts. New synergistic etching techniques using lasers and catalytic etchants have been developed that allow selective initiation of etch lines in semiconductor materials. Current research also focuses on the dynamic response of oxide powders to processing conditions. These powders hold great potential for development of composite ceramic materials with unusual electronic and structural properties. Additional research in this field centers on the formation of new forms of metal crystals and amorphous phases through non-equilibrium transformations, such as ion bombardment. Potential applications for this technique in the development of extremely tough, resistant surfaces are currently under study.

Colloid and surface science. (Profs. Bike, Curl, Gland, Gulari, Schwank, Thompson, and Ziff.) The department maintains an active research program in colloidal and interfacial phenomena. Current research areas, which are indicative of the diversity of faculty interests in this exciting field, range from mathematical analysis of emulsion stability to adsorption at liquid/solid interfaces. By combining a balanced effort in theory with sophisticated experiments, challenging problems can be investigated at all levels—ranging from the effect of molecular aggregation on diffusion to modeling pore blockage due to fines migration in porous media. Graduate-student research efforts are supplemented by advanced courses in colloids and surfaces jointly taught by faculty. Extensive computer facilities are available for numerical research complemented by experimental facilities covering all aspects of particle sizing, surface science instrumentation and laser, FTIR, and Raman spectroscopy. Some recent research accomplishments in colloidal and interfacial phenomena include development of a novel micro-emulsion-based means of oil-well stimulation, new Monte-Carlo methods for simulation of colloidal aggregation, and new methods for studying adsorption kinetics at the liquid/solid interface, and development of a novel light-scattering technique to measure colloidal forces.

Reaction engineering and catalysis. (Profs. Curl, Fogler, Gulari, Lastoskie, Montgomery, Savage, Schwank, Thompson, and Yang.) Research in reaction engineering, kinetics, and catalysis is prominent in our department. Several faculty members are active in this area, and they offer a range of opportunities for graduate research in challenging and timely projects. Current projects closely aligned with heterogeneous catalysis include catalyst characterization by surface and spectroscopic techniques, design and development of novel catalysts, and study of the fundamentals of metal/support and metal/metal interactions in catalysts. Reaction-engineering problems of current interest encompass flow and reaction in porous media, dissolution kinetics and catalysis, reactions in supercritical fluids, pyrolysis and oxidation pathways, kinetics and mechanisms, polymerization kinet-

ics, and degradation of complex macromolecular reactants. Additional projects associated with microelectronics include micromachining (laser-assisted chemical etching), and gas chemisorption on sensor surfaces. Research areas are typically explored both experimentally and theoretically, and physical and mathematical models describing the fundamental molecular phenomena are frequently developed. Practical applications can be found in many disparate technologies. Examples include hydroprocessing and hydrocracking, Fischer-Tropsch synthesis, stimulation of petroleum reservoirs, in-situ mining of minerals, pollution control, synthetic-fuels processing, and processing and developing microelectronic devices.

Transport phenomena. (Profs. Curl, Fogler, Lastoskie, and Wang.) Environmental transport phenomena are the common ground for ongoing research in three major studies currently underway in the department. One research project involves an investigation of the mechanisms and models for sorption of toxic substances on natural sorbents. Its goal is a more complete understanding of the different mechanisms of interaction of adsorbed toxic substances with the mineral and organic constituents of a sediment. A second research effort in the environmental transport field deals with the removal of trace pollutants from industrial waste waters. This micro-separations project focuses on producing means for the removal of compounds at low concentrations that are still considered hazardous to the environment. Its present emphasis is the development of modified, inexpensive clay sorbents that have a high affinity for dioxins and/or PCBs. Peat and peatlands are the background medium for a third research study of sorption, microbial and ecological processes; one aspect of this study centers on a detailed understanding of the interaction of metals in solution with peat. The goal is the identification of peat sorbents that can form the basis for new low-cost wastewater treatment processes to reduce pollution.

Process control and simulation. (Profs. Carnahan, Kravaris, and Ziff.) One direction in process control and simulation research area involves fundamental investigations in nonlinear control theory for the design of control systems for chemical processes. Applications include pH controllers in waste-treatment units and control systems for the optimal operation of batch and semi-batch processes, e.g., fermentors. Work is also performed on the control of distributed parameter systems with application to the control of particle-size distributions in crystallization processes. The development of well-conditioned, computationally efficient parameter-estimation algorithms is an additional research direction. Current research projects include estimation of constant parameters in systems described by a set of stiff ODEs and estimation of spatially varying parameters in systems described by PDEs. These algorithms have chemical reactor and petroleum reservoir applications, respectively. Research efforts in computer simulation include finite-element techniques for simulating flow processes, Monte-Carlo and molecular-dynamics techniques for simulating supercritical fluids, particle and

droplet aggregation, polymerization and catalyst surface kinetics, and dynamic simulation of large-scale stiff systems of ODEs using a variety of decomposition and integration techniques. Still other research involves development of software architectures and numerical methods suitable for dynamic simulation of large-scale chemical processes in highly parallel and distributed-computing environments.

Sensing and microelectronic materials. (Profs. Fogler, Gulari, Lastoskie, and Schwank.) Fundamental and applied research in microelectronics and sensing represents a new focal point in the department, bringing chemical engineering principles to bear on important problems in electrical engineering and materials science. In addition to theoretical efforts, several research groups in the department are actively engaged in various aspects of sensor research and development. From a strong background in sensor research for bioengineering and biomedical applications, the department is embarking now on development of a range of biosensor technologies designed to monitor intra- and extra-cellular conditions continuously. Major efforts are underway to develop a new class of sensors based on the use of optical fibers and specific protein receptors. Sensor research is expanding now into the realm of solid-state gas sensors based on microelectronic materials. Fundamental research on gas sensors is ongoing, with special emphasis on the effect of gas adsorption on the charge-carrier mobility in thin films and ultrasmall metal/insulator materials. In collaboration with the Department of Electrical Engineering, a multisensor array for monitoring gas composition is under development. New synergistic etching techniques involving lasers and catalytic etchants are being developed to allow precise control of etch profiles in the fabrication of silicon-based sensor materials. Optical etch enhancement in laterally-undercut microstructures is under investigation.

Electrochemical engineering. (Prof. Thompson.) Electrochemical engineering is an integral part of many emerging technologies, such as high-energy-density portable-power systems, metal-resource recovery, electronic materials processing, value-added processes in printed circuit-board manufacture, and controlled oxidation/reduction synthetic processes. Research generally involves the integration of thermodynamics, transport phenomena, kinetics and process design/simulation. A current major research effort centers on room-temperature molten salts as battery electrolytes. It studies the dissolution and deposition of active metal electrodes (e.g., aluminum, zinc, and magnesium) in the molten salts, the transport properties of the melts and solute species dissolved in the melts, and the oxidation/reduction characteristics of the electropositive electrodes in the areas of electrodeposition, electrowinning, electro-refining, and electroless plating (with more emphasis on non-aqueous systems). The laboratory has facilities for study of electrochemical kinetics and transport processes in aqueous or low-to-high temperature molten electrolytes. In addition, controlled-atmosphere dry boxes are available for study of organic or inorganic chemicals that are moisture- and/or

air-sensitive. Physiochemical properties of electrolyte solutions and their components are measured with the laboratory's densitometer, cone-and-plate viscometer, conductivity bridge, and RDE/RCE electrochemical systems.

Learning and teaching. (Profs. Carnahan, Curl, Fogler, Montgomery, and Wilkes.) Our department has long been known as the home of educational innovation. Educational materials—both textbooks and software—developed here have changed the way chemical engineering is taught throughout the country and the world. Michigan was an early advocate of instilling problem-solving and team-working skills to our students throughout the undergraduate curriculum.

An ongoing research project is an investigation of the diversity of learning styles of chemical engineering students, and the implementation and assessment of pedagogical techniques to address this diversity of learning styles. Part of this research focuses on the role of computer-based materials in addressing the learning needs of our students. In addition to the development of textbooks, many of our faculty are involved in the development of multimedia, spreadsheet, and virtual reality software for chemical engineering instruction.

RALPH T. YANG
Chairman, 1995–2000



Ralph T. Yang.

PROFESSOR Ralph Yang served as chairman of our department from 1995–2000, after being on the faculty at the State University of New York at Buffalo

(SUNY) for 17 years. At SUNY he held the Praxair Professorship of Chemical Engineering from 1993 to 1995, and served as chairman of the department from 1989 to 1995. Yang received his B.S. in chemical engineering from the National Taiwan University (1964), and his M.S. and Ph.D. in chemical engineering from Yale University (1968 and 1971).



Rane Curl at his retirement recognition, with his daughter Vittoria and wife Alice Rolfes-Curl, Michigan League ballroom, April 1997.

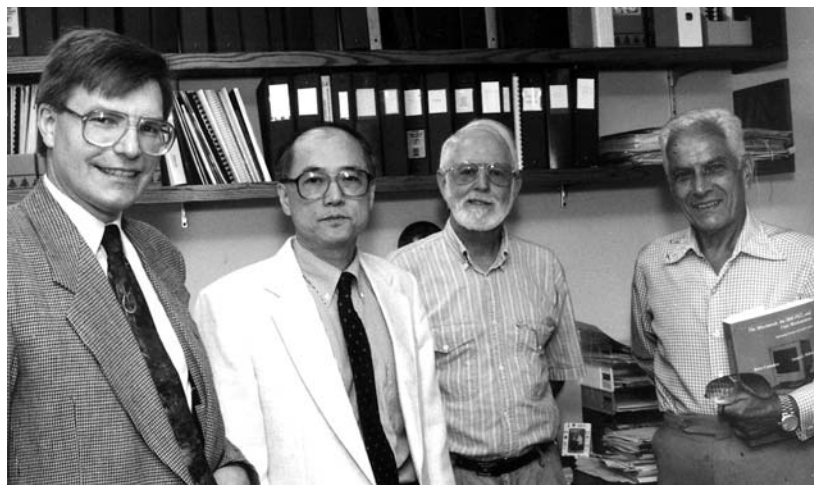

Johannes Schwank, Ralph Yang, and Brice Carnahan welcome a visit by Rasin Tek, 2000.

As department chairman, a top priority of Yang was to continue the strong tradition of excellence in both teaching and research. Because of several retirements during a five-year period (Bob Kadlec, Frank Donahue, Rane Curl, Dale Briggs, and Jim Wilkes), the recruitment of high-quality faculty was among the top agenda items for the department. Yang also strove to promote the faculty members' careers and to provide the best environment for them in which to conduct research and teaching.



Frank Donahue at his retirement recognition, with his wife Mary, Michigan League ballroom, April 1997.

Yang is proud of the faculty that he helped to recruit to the department during his chairmanship. Ron Larson joined the department in 1996 after declining offers from other top universities, and Mike Solomon (1997) and Rob Lionberger (1998) joined the department in the succeeding two years. These three, along with Stacy Bike, form the world's premier group in complex fluids. Ofer Blum joined the faculty in 1999 from Caltech, where he worked with the best group on drug design using bio-organometallic chemistry. Yang recalls with pleasure the faculty that he helped to recruit while he was at SUNY, saying "The ten faculty members that I helped to recruit would form a first-rate chemical engineering department. Two of them went on to receive major AIChE honors—the Colburn and Alpha Chi Sigma awards." Yang is very happy about his record on faculty retention. He likes to point out his "perfect record" on retention, as he did not lose a single faculty

member to other departments during his 11 years as a chairman at SUNY.



John Prausnitz and Ralph Yang, DLK Lecture-ship dinner, April 1997.

Yang also takes pleasure in recalling the promotions of his colleagues during his tenure at Michigan. Those promoted to full professor were: Costas Kravaris (1996), Bob Ziff (1997), Phil Savage (1998), and Levi Thompson (2000). Those promoted to associate professor with tenure were: Stacy Bike (1996), Mark Burns (1996), and Dave Mooney (1998). Yang himself was honored in 2002 by being appointed the Dwight F. Benton Professor of Chemical Engineering at the University of Michigan.

*Table 13 Total Numbers of U–M Degrees
Granted to Our Students, 1898–2000†*

B.S.E.	5,609
M.S.E.	2,064
Ph.D.	625

Yang is reluctant to talk about rankings—his philosophy is that what one is actually doing at present is important. However, he admits that rankings are also important. During his tenure, the excellence of our undergraduate program was maintained. The rankings for our graduate program was raised from about 17th or 18th to 11th (based on the published rankings).

During his term as the chairman, Yang was saddened to see the retirements of the old guards of the department. Brice Carnahan’s announced retirement in 2001

† Source, U–M Alumni Office.

will mark the passing of a generation of faculty that has its values and is highly respected and loved. Fortunately, Yang said, the recently “retired” faculty, along with Brymer Williams, Ed Young, and Maurice Sinnott, continue to interact with us and continue to contribute to the department in many ways other than teaching and research.

In May 1998, during Yang’s tenure, the department celebrated its Centennial, full details of which are given in Chapter 18. Finally, Yang notes in Table 13 the total numbers of degrees awarded from our department, although alumni who were deceased before 1972 were not included in the database.

From RONALD G. LARSON
Chairman, 2000–

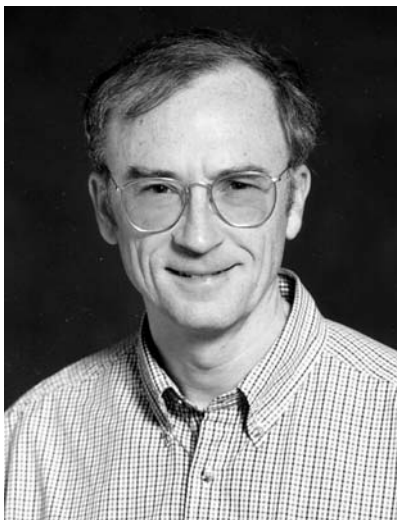

Bill Wood

Ronald G. Larson.

“THE department, 2000 and beyond. In my first year of chairing the Department of Chemical Engineering at the University of Michigan, I am grateful for the department’s strengths and its potential for further development. The department has a wonderful heritage of excellence, as is so ably documented in this history by Jim Wilkes. Not only is it a highly regarded department in its own right, it is also part of one of the top few engineering colleges in the country, in a first-rate university. The department has a diverse faculty and student body, perhaps more so than any other department in the college. The department has a collegial and dedicated faculty, who make decisions collectively in an open and friendly atmosphere.

The following is a brief summary of the department's accomplishments in teaching and research, and how I believe it might be able to grow even stronger in the next five to ten years.

Teaching. Despite a very high undergraduate enrollment, peaking at around 180 in the sophomore classes of the late 1990s, the department has maintained the excellence of its undergraduate education. This has been achieved in several ways. One has been by empowering one faculty member, Susan Montgomery, to dedicate herself solely to undergraduate affairs. Her close attention to the needs of the undergraduate students has given a personal touch to the undergraduate experience that would otherwise surely be lacking with such large classes, and the many distractions faced by faculty actively engaged in research as well as teaching. A second strong component of the undergraduate education has been the outstanding attention to teaching quality, and the communication skills, of our faculty. A number of our faculty have won teaching awards, and some are distinguished by extraordinarily high scores on teaching evaluations, in some cases exceeding a ranking of 4.5 on a scale in which 5.0 constitutes perfection. A third component is in the development of undergraduate teaching materials and textbooks. Notable examples include the blockbuster classic textbook by Carnahan and Wilkes on numerical methods and Scott Fogler's textbook and CD on reaction engineering. A recent addition to this tradition is the textbook on fluid mechanics by Wilkes, which is highly rated by the students for its readability, thoroughness, and accuracy. Having taught from it myself, I hope and expect that it will become the most widely used book on fluid mechanics in chemical engineering.

In addition to textbooks, the department has developed other ground-breaking educational materials, such as Montgomery's CD-ROM on chemical engineering equipment. I recall with pride how both this CD-ROM and Scott Fogler's book were cited by Felder of North Carolina State during his recent visit here as examples of some of the few really outstanding educational materials available for chemical engineering departments.

A fourth component is the constant evaluation and—if necessary—revision, of the undergraduate curriculum. I am proud to say that our department recently (May 2000) completed a year-long evaluation of its curriculum, resulting—amongst others—in a number of important changes, such as the addition of a required life-sciences course, and the addition of a new materials course. Our department has also been active in the development of interdisciplinary programs. An excellent example is the pharmaceutical engineering graduate program that has just recently been launched by Henry Wang, with support from the Parke-Davis pharmaceutical company. Another example is the polymer engineering master's degree program that is just now being introduced under the directorship of Stacy Bike.

Maintaining and surpassing this record of educational achievement over the next several years will be a challenge, to say the least. To do so, we will need to

replace retiring professors with ones who can teach with equal skill and dedication. To do so, I would hope that younger faculty members will draw on the resources and advice of retiring members, as they plan their courses, and hone their methods and styles of presentation. I would encourage younger faculty members to ask retiring members, such as Wilkes, for example, to sit in on some of their lectures and make suggestions for improvement. I know that I myself have a long way to go to achieve the teaching skills of the most outstanding teachers in our department.

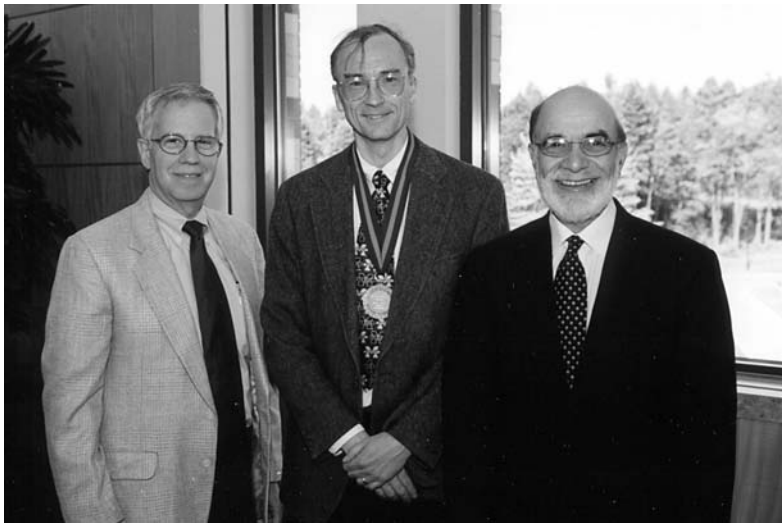

Bill Wood

Stephen W. Director (Robert J. Vlasic Dean of Engineering), Ronald G. Larson, and Fawwaz T. Ulaby (vice-president for research). On the occasion of Ronald Larson becoming the first G.G. Brown Professor of Chemical Engineering, 25 May 2000.

At the right moments, we will need other faculty members to write undergraduate books and materials. Success in such endeavors requires recognizing—before others do—that changes are required in material or pedagogy to advance the education of chemical engineers nationally and globally. This can occur within a single, existing, course, or in the reconstruction of the curriculum, which might lead to new courses within the core curriculum. There will be opportunities for new interdisciplinary educational programs at all degree levels. Rapid changes in technology and shifting boundaries between disciplines will no doubt create many opportunities for such developments. In addition, the World-Wide Web, distance learning, multimedia, and other revolutionary technologies will increasingly augment basic blackboard lectures and classroom question-and-answer sessions, creating additional scope for development of new educational materials. Scott Fogler and Susan Montgomery are especially active in these areas. While I believe that the classroom format (with lectures, question-and-answer, and break-out small

groups) will, despite technological advances, nonetheless remain the staple of the undergraduate experience, we will all need to be alert to alternative scenarios, if we are not to be left holding the buggy-whip.

Research. In research, the department distinguishes itself in several key areas, especially reactions, adsorption, materials-related research, mathematical modeling, biotechnology, and complex fluids. Reaction and kinetics have long been a departmental strength, and continue to be active areas of research for Profs. Schwank, Savage, Thompson, Fogler, Yang, Gulari, and Ziff. The addition of Ralph Yang to the faculty five years ago gave us a world leader in the area of adsorption. Mathematical modeling has long been a strength in the department, with continued work in the area of control theory and optimization by Costas Kravaris, porous-media modeling (and experiments) by Fogler, percolation and related theory by Ziff, modeling of reactions in high-temperature water by Savage, quantum chemical calculations by Yang, molecular, polymer, and colloid modeling by Lionberger and me, and receptor modeling by Linderman. Other faculty are active in theory and modeling as well.



Jennifer J. Linderman.

The areas of biotechnology and complex fluids have been growing especially rapidly within the department in recent years. In the biotech area, examples of recent prominent developments include Dave Mooney's research in tissue engineering, Henry Wang's work on bioreactors, Jennifer Linderman's work on receptors, Erdogan Gulari's work on DNA chips, and Mark Burns' recent success in building a multidisciplinary team to construct revolutionary "laboratories on a chip" for genomics and other biological assays. Other new faculty members are starting up at least part of their research in the bio area, including Mike Solomon, Rob Lionberger, and me. In the complex-fluids area, Solomon, Lionberger, Bike, and I have created a "complex fluids" community of students and faculty that meet together weekly for the "complex fluids seminars" arranged by Mike Solomon. Faculty

members have also been active in creating graduate educational materials. Examples are my book on complex fluids and Lauffenberger and Linderman's book on receptors. In addition, the books by Fogler and Wilkes are also used as graduate texts, as well as being outstanding undergraduate texts. Ralph Yang is in the process of producing a new book on adsorption, thus continuing the department's tradition in writing outstanding texts and monographs.

In the future, to be competitive with the best chemical engineering departments in the country, I believe that the department will need to build up interdisciplinary, interdepartmental, and intercollegiate research even more than it has in the past. Good target areas for such work include the bio area, where chemical engineering faculty could team up with faculty from the Biomedical Engineering Department, the Medical, Dental, and Pharmacy Schools, as well as biology, and other life sciences departments. Materials research is another prime candidate for collaborative teams involving faculty from the Materials Science & Engineering Department and the Mechanical Engineering Department. Another prime area is at the interface between chemical and electrical engineering, where MEMS (micro-electrical-mechanical systems) can be used for gas sensing, micro-reactors, and the like. No doubt, we will be surprised by the emergence of other, equally exciting areas for interdisciplinary work. The challenge for us will be to identify such areas, develop a vision and a game plan, and to risk the necessary time and energy to recruit team players from other departments and even other institutes and companies, and to persuade funding agencies to support the research. Finally, we will have opportunities to hire new faculty. If handled skillfully, this will allow us to develop new areas of interdisciplinary research and to enliven and refresh our department with new ideas and energies.

I firmly believe that our department is entering a truly exciting period, one in which we will all be rewarded by the efforts we make to renew and remake both our research and education. Michigan is indeed the right place to be!"

TEACHING AND THE CURRICULUM

THE UNDERGRADUATE CURRICULUM

Susan M. Montgomery

THE chemical engineering curriculum dates back to April 1898, when the Board of Regents of the University of Michigan approved a course of study leading to a bachelor of science degree in chemical engineering.

Table 14 *Distribution of Credit Hours in the Undergraduate Curriculum*^{†‡}

<i>Subject</i>	<i>1912</i>	<i>1931</i>	<i>1957</i>	<i>1980</i>	<i>2002</i>
Chemical Engineering	19	25	34	33	37
Chemistry	27	28	26	22	18
Physics	10	10	10	8	10
Biology	—	—	—	—	3
Mathematics	18	16	16	16	16
Surveying	2	—	—	—	—
Metal Shop	4	2	2	—	—
Mechanical Engr. & Mechanics	14	14	7	4	—
Electrical Engineering	4	4	4	4	—
Materials Science & Engineering	—	—	—	—	4
English	5	6	10	12	—
Modern Languages	16	16	—	—	—
Humanities and Social Science	—	—	—	9	12
Economics and Accounting	—	3	6	3	4
Drawing and Design	4	8	6	—	—
Digital Computing	—	—	—	2	4
Introduction to Engineering	—	—	—	—	4
Electives	17	8	14	15	16 [‡]
<i>Totals:</i>	140	140	135	128	128

[†] 1912–1980 data from Donald L. Katz, James O. Wilkes, and Edwin H. Young, “History of Chemical Engineering at the University of Michigan,” in *A Century of Chemical Engineering*, ed. William F. Furter, Plenum Publishing Corp., 1982.

[‡] Electives include six technical-elective credits, which must include at least two engineering credits and may include up to four advanced-science credits.

In 1925, the field of chemical engineering was recognized nationally as a branch of engineering, and the University of Michigan offered one of the 14 accredited curricula listed by the AIChE. As seen in Table 14, the curriculum has evolved with time to adapt to the changing needs of the profession and of our students.

Table 14 highlights the trends in chemical engineering education, starting from its origins in chemistry. The time devoted to supporting courses in chemistry, physics, and mathematics remains largely unchanged. Previously required courses in surveying, metal shop, mechanical engineering, and electrical engineering have been replaced by a greater number of elective credits, allowing students the flexibility to choose courses that will prepare them for a wide range of careers not only in traditional chemical engineering disciplines, but also, among others, in bioengineering, medicine, and law. English and modern-language requirements have also been broadened to humanities and social sciences. The economics requirement, so important to our students' understanding of how business works, has remained an almost constant feature of the curriculum. The changes in chemical engineering technology are reflected in changes in the chemical engineering course offerings.

Table 15 Chemical Engineering Courses Offered, 1911–12†

-
1. Fuels and Refractory Materials, Iron and Steel
 2. Chemical Technology
 3. Chemical Technology of Carbon Compounds
 4. Metallurgy of the Non-Ferrous Metals
 5. Micro-metallurgy
 6. Technical Examination of Gas and Fuel Laboratory
 7. Methods of Assaying Gold and Silver Ores
 8. Chemical Technology Laboratory
 9. Evaporation, Distillation, Filtration, and Transportation
of Liquids on the Manufacturing Scale
 10. Machinery and Processes for Conveying, Drying,
Calcinating, and Grinding
-

The chemical engineering courses offered in 1911–1912, listed in Table 15, focused primarily on chemical technology, compared with the current list of courses required for the B.S.E. (ChE) in 2002, shown in Table 16, with its emphasis on unit operations and engineering principles. The two laboratory courses allow students to practice the theory learned in the lecture courses both on the bench scale and the pilot-plant scale. In the capstone design courses, powerful computer simulators such as ASPEN are used in the design of chemical engineering plants. A second required design course was largely a materials course, and is now listed separately under Materials Science & Engineering (see Table 14).

† Katz et al., loc. cit.

However, the chemical engineering curriculum relates to much more than just technical knowledge. Students also learn how to communicate effectively, orally and in writing, to work in teams, and to solve open-ended problems. Teamwork is an integral part of the students' education, in that they work on homework sets and projects in teams in many courses, as well as on open-ended problems. Our department was one of the first in the nation to implement the use of open-ended problems throughout the curriculum, under the initiative of Prof. Scott Fogler.

Table 16 Chemical Engineering Courses Required for the B.S.E. (ChE), 2002

<i>Topic</i>	<i>ChE</i>	<i>Hours</i>
Thermodynamics I	230	4
Thermodynamics II	330	3
Fluid Mechanics	341	4
Heat and Mass Transfer	342	4
Separations Processes	343	3
Reaction Kinetics and Reactor Design	344	4
Process Control	466	3
ChE Laboratory I	360	4
ChE Laboratory II	460	4
Chemical Process Simulation and Design	487	4
<i>Total credit hours:</i>		37

The most recent changes to our curriculum are the result of a major college-wide review of the curriculum in 1996[†] and a subsequent departmental revision in 2001. Some of the recommendations of the task force included a greater number of elective credits, integration of technical communication into the laboratory and design courses, and the implicit integration of environmental and professional issues and the treatment of uncertainty within the core courses. Chemical engineering students now have the option of using their electives to earn a concentration in one of five areas—electrical engineering & electronic devices, mechanical engineering, materials science & engineering, life sciences, or environmental engineering. In terms of the increased number of options available to the students, we believe that this stresses the importance of proper mentoring to help the student choose those courses most appropriate to his or her future plans. A counseling system has been recently instituted in the department wherein each faculty member serves as a mentor to approximately 14 students during their stay in the department.

[†] *Michigan Curriculum 2000—Proposed Changes to the Undergraduate Curriculum*, University of Michigan College of Engineering Undergraduate Curriculum Task Force, April 2, 1996.

The chemical engineering curriculum at the University of Michigan has always been seen as a work in progress, adjusting as the needs of our profession and our students change. We aim to prepare our students to excel in any arena. That we are successful is evident in our students' ability in obtaining employment in a variety of technical areas as well as in post-graduate studies, such as chemical, pharmaceutical, or bioengineering, or in law, medical or business schools.

THE GRADUATE PROGRAM, 2002

At the graduate level, the past 25 years have seen a renewed emphasis on the doctoral degree. For most graduate students, the master's degree is now the first step towards the doctorate. Previously, the preliminary examination had been the famous "21-day problem," which amounted to an intensive three-week effort on a challenging project in chemical engineering design. For his 21-day problem, for example, the compiler of this history was asked to investigate the feasibility of liquefying natural gas from North Africa, shipping it to England, and regasifying it. That study involved a preliminary design of liquefaction and regasification facilities, special marine transport (with appropriate selection of materials for low-temperature storage), together with an economic evaluation of the project. Such a project was appropriate when our graduate program required a process-design course, but this no longer exists. Instead, the preliminary examination now involves the preparation and defense of a detailed research proposal, such as might be submitted to a funding agency. The current requirements for the master's and doctoral degrees are laid out below.

M.S.E. Degree

To enter the master's degree program, a bachelor's degree in chemical engineering or equivalent is required, together with a satisfactory undergraduate academic record and letters of recommendation. The requirements for the master's degree are:

- A total of 30 credit hours, with a minimum grade-point average of 5.0/9.0—that is, a "B" or better.
- 21 or more hours of chemical engineering graduate credits (for which up to six hours of graduate research, ChE 695, may be counted), to include:
 - The research survey course, ChE 595.
 - The fluid flow course, ChE 527.
 - The reactor analysis course, ChE 528.
 - A course in heat and mass transport.
 - Two courses from a selection of seven mathematics, modeling, and thermodynamics courses.
 - Between 4–9 hours of cognate credits, to include at least two relevant two-, three-, or four-credit-hour courses.

Ph.D. Degree

The requirements for the doctoral degree are:

- The M.S.E. requirements as listed above, or an appropriate master's degree from another institution.
- At least two ChE or related cognate 600-level courses.
- The doctoral seminar, either by electing the course ChE 895 or by making an oral presentation and submitting a written paper at a national or international technical meeting.
- A total of 37 graduate course hours, which cannot include credits for ChE 995 (precandidacy research) or ChE 995 (dissertation research) or more than six hours of ChE 695.
- Passing the Doctoral Qualifying Examination (DQE), the six-hour written part of which tests knowledge and ability in four principal chemical engineering science subject areas: fluid flow, transport phenomena, reaction engineering, and thermodynamics. The DQE is given twice yearly, in January and May. Three factors enter into the result of the examination:
 - The score on the written examination.
 - Overall academic performance in courses.
 - Faculty evaluations of the student.
- Passing the Preliminary Examination (PE), which evaluates a written and oral presentation of a research proposal on the student's anticipated dissertation project, and which is normally taken after passing the DQE.

Candidacy. After the DQE and PE have been passed and the cognate and Rackham fee requirements have been met, the student may apply to be a "doctoral candidate." While a candidate, he or she must elect eight hours of candidacy credits (ChE 995) each academic-year term, and may elect one (and only one) course per term without paying additional fees.

Selection of a faculty advisor. The student is normally assigned to a faculty advisor during the first half of his or her first term in the department. Faculty members present research topics during ChE 595, required of all entering students. Each student is expected to meet with four faculty members and to rank-order preferences for available research projects. Student/faculty assignments are made by the graduate-program chairman, taking into account student preferences, faculty preferences, and financial-support commitments.

Approval of the dissertation topic. The dissertation proposal includes the research summary that accompanies the PE proposal, a summary of the student's academic record, the names of the proposed chairman and committee members, the location of the research, and any health or safety precautions needed. It is submitted to the faculty for approval as the dissertation topic proposal.

Role of the doctoral committee. The doctoral committee consists of at least four graduate faculty members, at least two of whom are from the Chemical Engineering Department, (including the faculty advisor, who serves as chair of the committee), and at least one of whom must be from outside the department. The committee's role is to advise the student in the research activity, and to uphold departmental and university standards.



ChE 527 fluid mechanics class taught in Midland by James Wilkes and Steve Ceplecha, winter 2001. Top row: Brett Birchmeier, Stephen Ferguson, James Miller, Chad Buesing, Justin Jorgensen, Randy Woods; bottom row: Bedar Islam, Leenaporn Jongpaiboonkit, Ray Wright (course coordinator), Steve Ceplecha, Tina Islam, James Wilkes, March 2001.

Final oral examination. The doctoral committee approves the student's request to end the research effort and to write the dissertation. When the dissertation has been written and the format approved by the Rackham Graduate School, it is distributed to the committee, who then conduct the final oral examination (typically ten days to two weeks later). Once the thesis is successfully defended and approved by the committee, the Ph.D. degree is granted at the following university Commencement.

Departmental teaching/grading obligations. Each graduate student is

expected to serve as a teaching assistant for one course or as a grader for one or two undergraduate or graduate courses (depending on the course level and current enrollment) during one term of residence in the department. Normally, this obligation is met after the student achieves candidacy status.

The Midland program. Since the early 1950s, our faculty have taught one graduate course each term in Midland, Michigan, home of the Dow Chemical Company and the Dow Corning Corporation. These courses have enabled employees of these two companies to study part-time for their master's degrees. The classes meet twice weekly, typically at 5:00 PM, once for a two-hour lecture given by one of our faculty members (this involves a 220-mile round-trip drive from Ann Arbor) and once for a recitation led by an employee of the Dow Chemical Company. The endeavor has required a significant dedication, both by many members of our faculty and by the students who attend the classes after their normal working hours. Typically, two graduate courses are taught in Midland each year, with an average enrollment of about ten students in each course.

The Chulalongkorn program. As part of a coalition of universities originally formed by USAID seed funding, our faculty also teach on the average three or four intensive courses at Chulalongkorn University in Bangkok, Thailand, to master's degree students in petrochemical technology and polymer science. This program has been self-sustaining for the past five years (USAID seed funding ended in 1996) and graduates annually about 30 students in petrochemical technology and about 20 in polymer science. The teaching is done during the summer and does not impact the teaching responsibilities in Ann Arbor. The graduates of the program are primarily hired by multinational companies operating in south-eastern Asia and are rising rapidly through the ranks to controlling positions despite the Asian economic slump of the late 1990s. Full details of the program are given in Chapter 16.

Combined B.S.E./M.S.E. program. During the academic year 1999–2000, we introduced the SGUS† program, in which a student could obtain combined B.S.E. and M.S.E. degrees in five years. In terms of enrollments, the program has been a great success. However, to keep the quality high, we are limiting the number of SGUS admissions to roughly half of the doctoral program admissions—the latter amounting to between 15 and 20 each year.

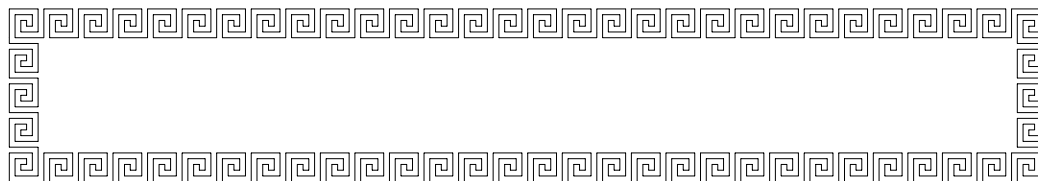

† Simultaneous graduate and undergraduate studies.

THE GERMAN LANGUAGE EXAMINATION†

by Marshall B. Standing, Ph.D. 1941

I N 1940, I was trying to finish up work toward a Ph.D. degree. I had been at this since fall of 1936 and it then looked as though success might come at last. However, there was one hurdle that I wasn't too well prepared for. That was passing a written examination in German-language usage. The rules were, at that time, that a candidate for the Ph.D. degree should demonstrate a certain amount of proficiency in both French and German prior to taking their final examination.

During 1939 and 1940 I had signed up for several non-credit courses in German. Because of the press of other things I never completed any of these courses! But I had, at various times, started a self-study program of translating articles from the *Petroleum Zeitschrift*, 1934. In fact, I spent eight hours a day during the whole 1940 Christmas vacation laboriously looking up words in my German-English dictionary in an effort to translate *Zeitschrift* articles.

The examination was a written one. When ready, the candidate appeared before the examiner with three books from which he was to “demonstrate” ability with the given language. The examiner then selected an article and gave the candidate an hour, or maybe one-and-a-half hours to translate the article. A week later you went back to get the sad/good news.

I need to explain a political (?) point in effect at that time. For a number of years the examiner had been an elderly gentleman who took what could be considered as a somewhat relaxed view of the process. At least that was my impression. Many candidates passed on the first try. However, he died, and the assignment of giving the examinations was passed to the Language Department. It appeared as though their policy was to be sure that the candidates *really* understood German. The result was that the examinations were stricter and the resulting pass/fail ratio declined towards zero. So the Language Department was released from giving the exams and a new, more tolerant, examiner was appointed. After all, it was important that the flow of doctorates should continue.

On the appointed day I arrived at the examiner's office with my three textbooks. The examiner opened the *Petroleum Zeitschrift* to an article and asked me “Have you read this one?” It looked familiar to me, and being an honest soul, I answered affirmatively. So he selected a second article, which also looked familiar. So I again answered “yes.” The third article looked less familiar than the first two so I said “No.” After all, I thought, a little bit of familiarity might help in getting a passing grade. The examiner looked at the article again and said “A little difficult perhaps, but let's see what you can do with it.”

When I got started on the translation I could see why the article did look somewhat familiar. It was one that I tried to translate three or four times, but because of its difficult syntax I had never been able to get past the third paragraph.

† A knowledge of two foreign languages was required of doctoral students until about 1970, but not since.

When I returned for my grade I was sure that I had failed. My “translation”—if it could be called one—was a sea of red pencil marks. It looked as if I had missed everything—words, sentences, and paragraphs. Luckily the examiner had the right attitude. He said “It looked somewhat difficult and I hesitated to give it to you. But you got a couple of words right. So I guess you pass.”

Since leaving Ann Arbor I have worked in petroleum engineering research and management assignments. I have also taught several university-level courses in petroleum engineering. But in the total of 55 years I have never had to translate another German language article. Just lucky, I guess.

RECENT COURSE OFFERINGS, 2002

THE courses in Table 17 were taught during the seven-year period ending in the winter term 2002.

*Table 17 Chemical Engineering Courses, 1995–2002.
Special designations: Required courses: undergraduate, U; graduate, G. Cross-listed with MSE, M.*

<i>Number</i>	<i>Title</i>
230 U	Thermodynamics I
290	Directed study, research, and special problems
330 U	Thermodynamics II
341 U	Fluid mechanics
342 U	Heat and mass transfer
343 U	Separation processes
344 U	Reaction engineering and design
360 U	Chemical engineering laboratory I
412 M	Polymeric materials
414 M	Applied polymer processing
417	Biochemical technology (became 517)
444	Applied chemical kinetics
447	Waste management in chemical engineering
460 U	Chemical engineering laboratory II
466 U	Process dynamics and control
470	Colloids and interfaces
472	Polymer science and engineering
486 U	Chemical process simulation and design I
487 U	Chemical process simulation and design II
490	Directed study, research, and special problems

496	Special topics in chemical engineering
507	Advanced math. modeling in chemical engineering
508	Applied numerical methods
509	Statistical analysis of engineering experiments
510	Mathematical methods in chemical engineering
511 M	Rheology of polymeric materials
512 M	Physical polymers
517	Biochemical science and technology
518	Engineering fundamentals in biological systems
519	Pharmaceutical engineering
527 G	Fluid flow
528 G	Chemical reactor engineering
538	Statistical and irreversible thermodynamics
542 G	Intermediate transport phenomena
543	Advanced separation processes
566	Process control in the chemical industries
580	Teaching engineering
583 M	Biocompatibility of materials
584	Tissue engineering
595 G	Chemical engineering research survey
596	Pharmaceutical engineering seminar
607	Mathematical methods in chemical engineering
616	Analysis of chemical signaling
617	Advanced biochemical technology
628	Industrial catalysis
629	Complex fluids
695	Research problems in chemical engineering
696	Selected topics in chemical engineering
697	Problems in chemical engineering
698	Directed study in chemical engineering
751 M	Special topics in macromolecular science
990	Dissertation/pre-candidate
995	Dissertation/candidate

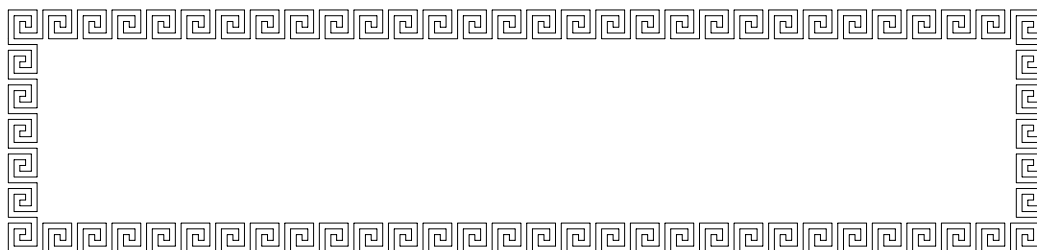

INNOVATIONS IN CHEMICAL ENGINEERING EDUCATION, 1898–1998

by H. Scott Fogler†

“THE University of Michigan almost from its beginning recognized the importance of teaching the applications of chemistry to industrial life,”—*Encyclopedic Survey of the University of Michigan* Vol. VII, 1953.

Here, we highlight the innovations to chemical engineering education by the faculty of the University of Michigan. It is not intended to describe all of the curricular changes over the last 100 years, but only those in which Michigan was a leader in making those changes in chemical engineering. Many of these changes were brought about through the publication of textbooks, most of which are listed in Table 18 at the end of this article. Other innovations in the department are discussed by decade, although it was difficult to find material on the first 30 years.

1898–1930: The beginning. In 1917, the Swenson Evaporator Company of Chicago offered to install evaporator equipment at the university free of cost if the company in exchange might employ the services of Professor W.L. Badger as a research consultant. This offer was accepted by the Board of Regents, and space was found in the abandoned boiler house in the center of the campus for this equipment. In spite of an ill-suited location for the evaporators, good results were obtained by the students and staff. This equipment marked the beginning of the “unit operations” undergraduate teaching laboratories, embodied today in ChE 460.

1930s: Mathematics in chemical engineering. The University of Michigan was one of the first educational institutions to recognize the importance of mathematics in describing chemical engineering processes in both teaching and research. As a result, the department recruited Professor of Mathematics, T.E. Running, to teach in the Chemical Engineering Department. Based on his course material he wrote two books, *Graphical Calculus* and *Differential Equations in Chemical Engineering*, which were published locally. The involvement of a mathematics professor to this degree in teaching chemical engineering fundamentals was a true innovation at the time.

1940s: The curriculum revision. Michigan was one of the first chemical engineering departments to have contract research, which was initiated by Professor Albert E. White in 1924. It was out the contract research that the concept of undergraduate research projects was born (continued in the current ChE 490). It was also during the 1940s that courses in thermodynamics and reaction kinetics were introduced into the curriculum. Professor George Granger Brown introduced

† With contributions by Peter B. Lederman on the Ford Foundation project.

thermodynamics, for many years an important graduate course, but then also at the junior level for both chemical and metallurgical engineering students. The fuels laboratory was changed to a general measurements laboratory.

A major change in the curriculum began during the period of low enrollment in World War II and continued for several years thereafter. The courses in organic and inorganic technology and the required senior thesis course were discontinued.

1950s: Unit operations and the emergence of computing in chemical engineering. Along with contract research, one of the major factors that brought Michigan to the forefront was the publication of the book by G.G. Brown et al., *Unit Operations*. This book was a communal effort that brought members of the department closer together.

The Ford Foundation project, “The Use of Computers in Engineering Education,” helped to put the University of Michigan and the Department of Chemical and Metallurgical Engineering firmly in the forefront of digital computing for the second half of the 20th century. The program, initiated by Prof. Donald Katz in 1959, then chairman of the department, was one of the first foundation-supported programs to enhance engineering education. The use of computers for research work was already well entrenched in the mid to late 1950s. But the use of computers in courses was not. It was Don Katz’s vision to develop expertise in the faculty, course content, and training for students as a demonstration so that computers would become what they are today—the common tool for the engineer to solve evermore-complex problems. The Chemical and Metallurgical Engineering Department was the focal point in that program, and many faculty from numerous universities came to Ann Arbor to develop teaching materials and problems suitable for the introduction of digital computation into their courses. It was in the latter stages of the Ford Foundation project that Professors Wilkes and Carnahan began to collaborate with H.A. Luther on their textbook, *Applied Numerical Methods*.

1960s: The computer-problem era. During the early to mid 1960s, ten new assistant professors were hired in the chemical engineering part of the department. The new faculty, who came from both industry and academia, began to build the computing initiative started at the end of the last decade. Professors Wilkes and Carnahan published the first book on numerical methods, which was a great success. Research on computing found its way into the undergraduate curriculum. Beginning in the mid 1960s the department decided to assign a computer problem in virtually every undergraduate course. These problems were quite comprehensive and required many hours of student programming and key punching. Professor Rane Curl spent much effort in preparing real-world problems for the undergraduates to attack. Most of these problems had an open-ended content that allowed students to explore parameters on their own. This exploration is a philosophy that still exists in the department today.

1970s: The software-development era. Small classes were the focus in the early 1970s. One time at the staff meeting at the beginning of the term in the late 1960s there were 46 students in the fluid mechanics class and the chairman broke the students into three classes ranging from 12 to 18 students per class and each class was taught by a professor! Even with small classes, there was apprehension among the students because they did not know whether or not they would go to Vietnam after graduation. In the middle of the following decade this uneasiness subsided. A separations class was introduced by Jack Powers as a required course. Teaching innovations implemented in reaction engineering were guided design and the Keller self-paced plan. Two textbooks were published, both by Prentice Hall, one on thermodynamics by Dick Balzhiser (with coauthors M.R. Samuels and J.D. Eliassen) and one on chemical kinetics and reactor design by Scott Fogler.

During the mid 1970s the first interactive instruction modules were developed in chemical engineering. These first modules included the now-famous inspector Columbo scenario that used basic chemical engineering principles to solve a murder mystery. These first sets of modules were developed by an undergraduate student, Michael Duncan (now a professor of chemical engineering at Cornell University), and Professor Scott Fogler. These modules formed the foundation for the module development that was to take place in the 1980s.

In the late 1970s and early 1980s, Brice Carnahan and a cadre of student assistants developed, under NSF sponsorship, some of the earliest computer-based courseware for chemical engineers. The MicroCACHE software, consisting of executive routines for module authoring and presentation, and several instructional models for numerical methods and flowsheeting, was originally developed for the Apple II personal computer and later converted for use on the IBM PC. The MicroCACHE work was followed in the mid-to-late 1980s by development of the more powerful MicroMENTOR system software and courseware, which is currently being used as the principal delivery vehicle for networked access, control, delivery, and statistics-gathering for all IBM PC-based software used by students in the Chemical Engineering Department at Michigan (including the newest Michigan instructional modules developed under the direction of Michigan Professors Fogler and Montgomery and distributed by CACHE).

1980s: The open-ended problem era. James Duderstadt became dean of the College of Engineering in 1981 and one could sense the changes that were to take place during his tenure. Our department was offering every course every term, no matter how low the enrollment. The majority of the faculty's time was in the classroom. The department arranged an agreement with Dean Duderstadt that if we reduced course offerings to once a year, the faculty would spend an "almost" equivalent amount of time to focus on other aspects of the student's development, primarily open-ended problem solving and the development of interactive comput-

ing modules. The idea was that we could not rely on a single senior design course to teach synthesis, but instead synthesis skills had to be practiced in every single course. In the mid 1980s, the department received a quarter-of-a-million dollar grant from the National Science Foundation to develop course-specific open-ended problems (OEPs) for use throughout the curriculum. Through numerous visits of faculty and students to a number of companies and different industries, the plan of an OEP in every course was implemented. The curriculum at Michigan was unique. The AIChE student chapter assembled a one-page flyer describing the uniqueness of Michigan's department and then stapled that to their résumés. The student chapter also prepared a booklet on how to succeed in chemical engineering at the University of Michigan. During the mid 1980s the first edition of the *Elements of Chemical Reaction Engineering* by Fogler was published.

1990s: The multimedia era. The multimedia era really began in the late 1980s with grants from the National Science Foundation that totaled over half a million dollars. Twenty-six interactive computer modules were developed by the faculty and undergraduate students in the department. Professor Scott Fogler and Dr. Susan Montgomery spearheaded this effort, with major contributions from Professors Jennifer Linderman, Stacy Bike, and Levi Thompson. These modules were distributed by the CACHE Corporation and, some five years later, over half the chemical engineering departments across the nation still licensed and used these modules.

Shortly after the completion of this project, Professor Montgomery joined the department as a faculty member and began her own work in multimedia lessons. Seeing the increasing interest in chemical applications in the biological area, she led a team of faculty and students who developed five multimedia modules devoted to chemical engineering applications in biological systems. These modules present key chemical engineering concepts in the context of biological applications. These modules have been distributed by the CACHE Corporation to chemical engineering departments across the country. Multimedia modules have also been developed for the material balances course, including modules on multiphase systems and psychrometry. Multimedia tours of Ann Arbor's wastewater treatment plant and Ford Motor Company's Wixom plant phosphate coating systems expose students to applications of material balances in real systems.

In order to help students learn about the equipment used in chemical engineering processes, Dr. Susan Montgomery and a team of students have developed a compact disk entitled *Encyclopedia of Chemical Engineering Equipment*, which includes many pictures, movies, and animations. For each piece of equipment, students learn details of its design, applications, advantages and disadvantages, and are given a reference list should they want additional information.

The department continues its effort to foster the writing of textbooks. Professor Wilkes's book *Fluid Mechanics for Chemical Engineers*, with contributions

by Stacy Bike, was published by Prentice Hall in 1999. The 1990s include the second and third editions of Professor Fogler's book on chemical reaction engineering (which has become the dominant book on that subject during the 1990s). The third edition of this book is the first to contain living example problems on a CD ROM, as well as being a hybrid of information distributed on CD ROM and in the printed text. In 1994, Dr. John Bell joined the department as an instructor and developed the first virtual-reality modules for use in chemical engineering.

Table 18 Textbooks Authored by Michigan Chemical Engineering Faculty†

-
- 1913: *Technical Gas and Fuel Analysis*, A.H. White, McGraw-Hill, New York.
- 1923: *Motor Fuels: Their Production and Technology*, E.H. Leslie, the Chemical Catalog Company, New York.
- 1928: *Inorganic Chemical Technology*, W.L. Badger and E.M. Baker, McGraw-Hill, New York.
- 1931: *Elements of Chemical Engineering*, W.L. Badger and W.L. McCabe, McGraw Hill, New York.
- 1939: *Engineering Materials*, A.H. White, McGraw-Hill, New York.
- 1948: *Natural gasoline and the volatile hydrocarbons*, G.G. Brown and G.G. Oberfell, Natural Gasoline Association of America, Tulsa.
- 1950: *Unit Operations*, G.G. Brown and associates—A.S. Foust, D.L. Katz, R.R. White, R. Schneidewind, W.P. Wood, G.M. Brown, L.E. Brownell, J.J. Martin, G.B. Williams, J.T. Banchemo, and J.L. York—John Wiley and Sons, New York.
- 1955: *Introduction to Chemical Engineering*, W.L. Badger and J.T. Banchemo—McGraw-Hill, New York.
- 1958: *Fluid Dynamics and Heat Transfer*, J.G. Knudsen and D.L. Katz, McGraw-Hill, New York.
- 1958: *The Solid State for Engineers*, M.J. Sinnott, John Wiley and Sons, New York.
- 1959: *Handbook of Natural Gas Engineering*, D.L. Katz, D. Cornell, R. Kobayashi, F.H. Poettmann, J.A. Vary, J.R. Elenbaas, and C.F. Weinaug, McGraw-Hill, New York.
- 1959: *Elements of Materials Science*, L.H. Van Vlack, Addison-Wesley, Reading, Mass., with several subsequent editions.

† Excluded from this table are: bound volumes that are essentially sponsored-research project reports, books written by faculty after they have left the department for another university, books by faculty members on the materials and metallurgical side after the 1970 split into two divisions, edited conference proceedings, and isolated chapters in books.

- 1959: *Process Equipment Design*, L.E. Brownell and E.H. Young, John Wiley and Sons, New York.
- 1968: *Engineering Concepts and Perspectives*, D.L. Katz, R.O. Goetz, E.R. Lady, and D.C. Ray, John Wiley and Sons, New York.
- 1969: *Applied Numerical Methods*, B. Carnahan, J.O. Wilkes, and H.A. Luther, John Wiley and Sons, New York.
- 1972: *Chemical Engineering Thermodynamics—The Study of Energy, Entropy and Equilibrium*, R.E. Balzhiser, M.R. Samuels, and J.D. Eliassen, Prentice Hall, Upper Saddle River, New Jersey.
- 1973: *Digital Computing and Numerical Methods*, B. Carnahan and J.O. Wilkes, John Wiley and Sons, New York.
- 1974: *Elements of Chemical Kinetics and Reactor Design—A Self-Paced Approach*, H.S. Fogler, Prentice Hall, Upper Saddle River, New Jersey.
- 1986: *Elements of Chemical Reaction Engineering*, H.S. Fogler, Prentice Hall, Upper Saddle River, New Jersey. Second edition, 1991. Third edition, 1998.
- 1987: *The Underground Storage of Natural Gas*, M.R. Tek, Gulf Publishing Company, Houston.
- 1989: *Receptor/Ligand Sorting along the Endocytic Pathway*, J.J. Linderman and D.A. Lauffenburger, Springer-Verlag, New York.
- 1990: *Natural Gas Engineering, Production, and Storage*, D.L. Katz and R.L. Lee, McGraw-Hill, New York.
- 1993: *Receptors: Models for Binding, Trafficking, and Signaling*, D.A. Lauffenburger and J.J. Linderman, Oxford University Press, New York.
- 1994: *Strategies for Creative Problem Solving*, H.S. Fogler and S.E. LeBlanc, Prentice Hall, Upper Saddle River, New Jersey.
- 1994: *Applied Fluid Mechanics*, T.C. Papanastasiou, Prentice Hall, Upper Saddle River, New Jersey.
- 1994: *FORTTRAN for the Macintosh and IBM PS/2*, B. Carnahan and J.O. Wilkes, published by the authors, Ann Arbor.†
- 1996: *Natural Gas Underground Storage*, M. Rasin Tek, PennWell Publishing Co.
- 1996: *The Macintosh, the PC, and Unix Workstations*, B. Carnahan & J.O. Wilkes, published by the authors, Ann Arbor.†
- 1996: *Treatment Wetlands*, R.H. Kadlec (with R.L. Knight), CRC Publishing Co./Lewis, Boca Raton, Florida.

† The last of a long series used in U–M freshman engineering computing courses.

- 1998: *The Structure and Rheology of Complex Fluids*, R.G. Larson, Oxford University Press, Lavallette, New Jersey.
- 1999: *Fluid Mechanics for Chemical Engineers*, J.O. Wilkes, Prentice Hall, Upper Saddle River, New Jersey.
- 2002: *A Century of Chemical Engineering at the University of Michigan*, compiled by J.O. Wilkes, Department of Chemical Engineering, University of Michigan, Ann Arbor, Michigan.
-

CHEMICAL ENGINEERING UNDERGRADUATE LABORATORIES FROM 1987 TO 2002

by Pablo LaValle

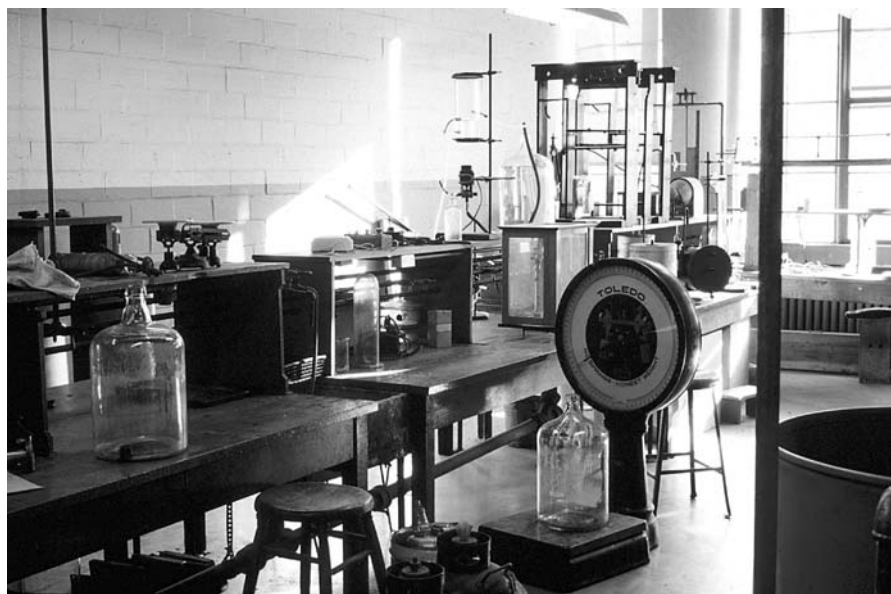

James Wilkes

Eastern bay of the Chem-Met 16 measurements laboratory on the 4th floor of East Engineering, before renovation by Prof. Wilkes in 1963 as part of the new Chem-Met 344 rate processes laboratory, which eventually evolved into the present ChE 360 laboratory.

Introduction. In 1987, the state of the two four-credit hour undergraduate teaching laboratories (ChE 360 and ChE 460) was less than excellent and a program was put in place to bring them to a higher level of performance and safety. The author, with expertise in electronics and equipment design and fabrication, had then recently been hired by the department to assist in the complete renovation and maintenance of these two laboratories, as detailed below.



James Wilkes

Pablo LaValle with the ChE 360 laboratory miniature cooling tower, June 2000. Designed by Pablo and built by him and Don Trombley.

Junior laboratory (ChE 360). In 1987, the department applied for and received about \$50,000 from the NSF for instrumentation and laboratory improvement and started the reconstruction of the junior laboratory, ChE 360, under the direction of Prof. James Wilkes, in close collaboration with the author. Before renovation, there were only four experiments in ChE 360 (double-pipe heat exchanger, vapor diffusion in a capillary tube, tank-draining, and specific-heat determination), and the main focus of the laboratory was a detailed statistical analysis of the results obtained from these experiments. Two years later, the laboratory was moved to the newly constructed facilities in room 3458 of the G.G. Brown Building and a totally renovated laboratory with all reconstructed or new equipment was in place.

We set as goals the following features of the new laboratory:

1. A selection of at least ten available experiments, corresponding to a wide range of chemical engineering topics.

2. Emphasis on an understanding of physical principles.
3. Maximum exposure to “live” equipment and experiments, rather than employing other potentially useful tools such as computer simulations and videotapes.
4. Simplicity of design and operation, producing equipment that can be relied on not only to “work,” but that needs minimal attention once constructed.
5. Avoidance of expensive analytical equipment, in order to keep the total equipment cost within reasonable bounds—about \$50,000 in 1987, as it transpired. Consequently, reliable equipment and the “right way” of doing things could be pursued without worrying unduly about cost.
6. Incorporation of microcomputers for data acquisition and processing in most of the experiments.
7. Close attention to student feedback, to determine which experiments were “meaningful,” and which features should be enhanced or minimized.
8. Illustration in a few cases of physical principles not yet learned in other required courses. For example, one experiment beneficially introduced *process control*, even though the students were not taking the required course on this topic for another year.
9. Consultation with faculty, as appropriate, to insure that experiments were complementary to the material presented in other courses.

The new *additional* equipment at that time in the junior laboratory included:

- A miniature shell-and-tube heat exchanger that could be used with counter- or co-current flow.
- A transient heat-conduction apparatus to estimate the thermal diffusivity of metals, involving Fourier analysis of temperature “waves.”
- A series of two CSTRs to characterize the residence-time distribution in stirred tanks.
- A cation-exchange column that could be used in packed-bed or fluidized-bed mode.
- A feed-back temperature control in a system with recycle.
- A centrifugal-pump apparatus for the characterization of pumps and prediction of flow in pipes.
- A vapor-pressure cell for the determination of enthalpy of vaporization from pressure-temperature relations.
- A two-phase apparatus to study the slug-flow regime in vertical pipes.
- A water cooling-tower for the characterization of mass transfer in a structured packing.

The students worked in groups of two or three, and also attended one or two associated lectures each week in which the following items were discussed: safety, statistical analysis of experimental data, report writing, and additional material needed for the conduct of certain experiments.

More recently, under the supervision of Professor Henry Wang, the following experiments have also been incorporated into ChE 360 since 1994:

- An air-lift bioreactor to perform dynamic measurement of the oxygen transfer coefficient in brewer's yeast.
- A microfiltration apparatus to characterize the properties of a Rohm & Haas microfiltration fiber for yeast concentration and separation from a dilute slurry.

This last experiment was supported by a gift from the Procter and Gamble Company.

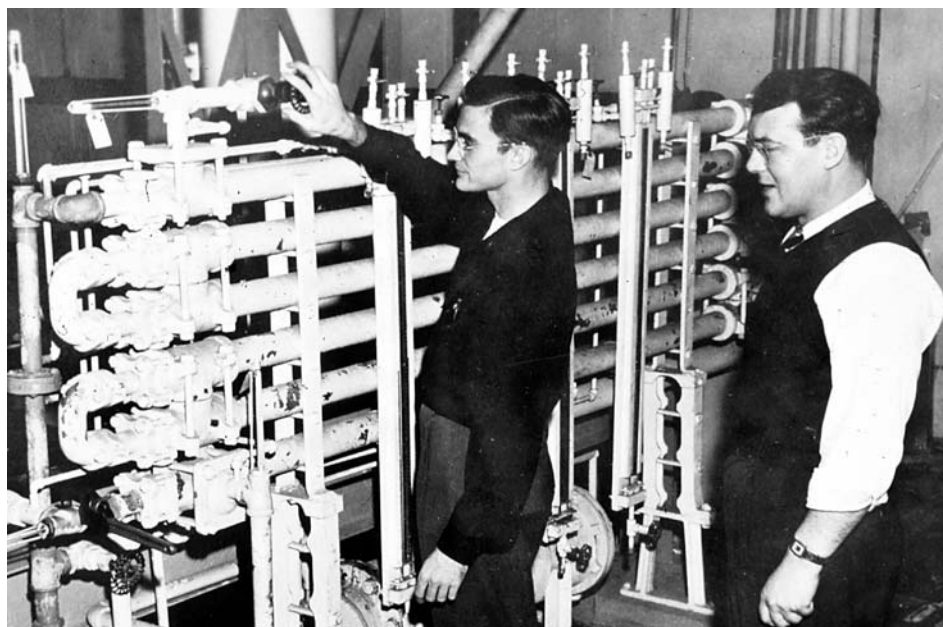

Brymer Williams (R) and (probably) Leo Treat (L) with the double-pipe heat exchanger in East Engineering. The equipment eventually formed one of the experiments in the ChE 360 laboratory in the first floor of the G.G. Brown Building.

Senior laboratory (ChE 460). In the senior laboratory a program was also undertaken, under the direction of Prof. Rane Curl, to increase the safety and reliability of the existing equipment, as well as the addition of new equipment. The laboratory was also revamped to eliminate some serious electrical hazards and other safety problems, and the existing equipment was repaired and modified as the curriculum changed.

As ChE 460 was forced to reduce the space it occupied in the in the G.G. Brown Building (all the space in the first floor was allocated to another department) the items of equipment located there (a large distillation column and a long-tube vertical evaporator) were eliminated from the laboratory.

The distillation column was replaced with a laboratory-size packed-bed distillation column currently used to characterize mass-transfer coefficients in random packing and to optimize distillation operations utilizing a methanol/water system.

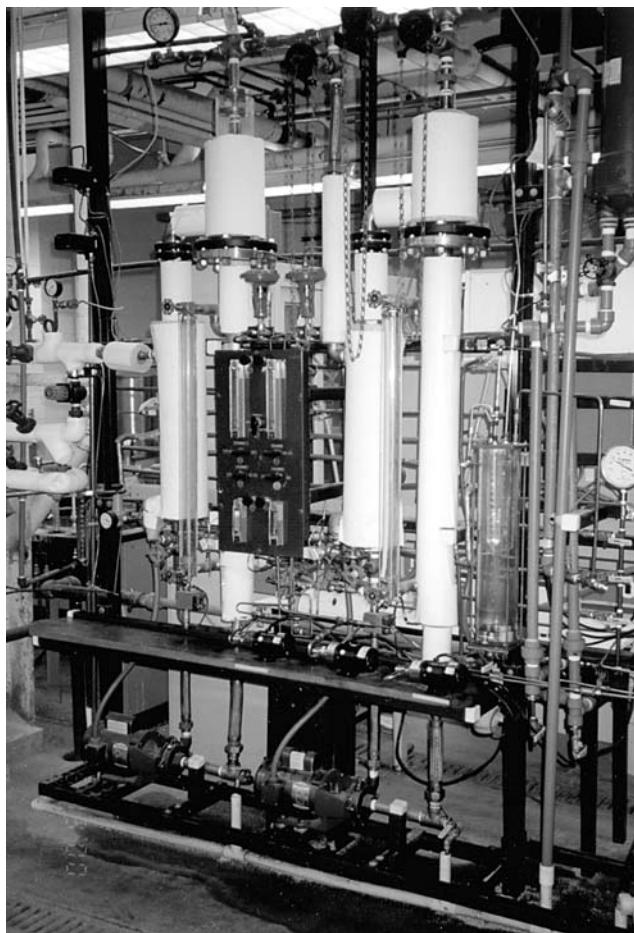

James Wilkes

ChE 460 laboratory double-effect evaporator, June 2000. Used for separation of glycerol and water. Designed by Pablo LaValle and built by him and Don Trombley.

The long-tube vertical evaporator was replaced with a new pilot-plant scale double-effect evaporator designed and constructed by our staff. This evaporator can be used in single- or double-effect mode with forward, parallel or backward feed and at atmospheric or reduced-pressure conditions. It is currently being used to evaluate multiple-effect evaporation with a water/glycerol system. A computer is used for process control and data logging in this equipment.

In 1990 we designed and constructed, in cooperation with Mr. Masoud Sou-rush (a doctoral student in the process-control research group), a reaction cell that was used for three years in a polymerization research project and was finally permanently installed in the senior laboratory as a much-needed project in reaction engineering. Currently, the reaction cell includes a three-liter jacketed glass reactor with heating and cooling capabilities, a one-liter adiabatic reactor and related instrumentation and computer for data logging and process control. The reaction project now involves the reduction of the chemical oxygen demand of waste solutions by oxidation with hydrogen peroxide.



The 18-inch ethanol/water distillation column, which was one of the experiments in the ChE 460 laboratory on the first floor of the G.G. Brown Building. Doctoral student Robert Norman is on the upper level.

With the addition of the reactor cell the senior laboratory now contains five working experimental stations that include a process-control project, a reaction project and three separation projects (distillation, evaporation, and filtration).

In conjunction with the equipment improvement, the curriculum in the senior laboratory evolved, under the direction of Professor Rane Curl, into a more realistic simulation of an industrial environment, also known as “Brown Industries Inc.” In this organization the students take the role of engineers working on a process that needs to be characterized and optimized. This work is accomplished during the course of a semester by assigning different aspects of each process to different teams of engineers. At the end of the semester, all the progress accomplished by the various teams must be brought together by the final team to accomplish the overall objective set out at the beginning of the term.

The remainder of the Procter & Gamble gift was used to replace the computer equipment in ChE 460 and to construct three constant-temperature baths used in both laboratories for calibration of temperature sensors.

Conclusion. Future plans for the undergraduate laboratories include expanding and moving the junior laboratory to a larger facility in the projected Dow building expansion, and adding a new experimental station and modifying the process-control system in the senior laboratory. The junior laboratory move and expansion will allow the entire junior class to take the laboratory in one semester, thus minimizing scheduling problems; the new equipment in the senior laboratory will help modernize and replace some of the older equipment now in use.

DEGREES GRANTED, 1898–2002

Table 19 Degrees Granted by Decade†

<i>Decade</i>	<i>B.S.E.</i>	<i>M.S.E.</i>	<i>Ph.D.</i>
1898–1908	72	—	—
1908–1918	283	40	1
1918–1928	365	68	13
1928–1938	367	218	60
1938–1948	712	316	41
1948–1958	747	432	101
1958–1968	491	293	152
1968–1978	529	214	72
1978–1988	1,037	219	65
1988–1998	1,004	126	126
1998–2002	480	69	38
<i>Totals:</i>	6,087	1,995	669

† Sources—pre-1978: Donald Katz, James O. Wilkes, and Edwin H. Young, “History of Chemical Engineering at the University of Michigan,” from *A Century of Chemical Engineering*, ed. William F. Furter (Plenum Publishing, 1982); post-1978: Tamika L. Young, from departmental degree lists.

Table 20 Degrees Granted by Chemical Engineering Departments, 1998–1999

<i>University</i>	<i>Faculty</i>	<i>B.S.</i>	<i>M.S.</i>	<i>Ph.D.</i>
Arizona	12	37	3	4
Arizona State	12	46	12	3
Auburn	16	81	12	11
UC Berkeley	19	73	2	18
UC Davis	24	53	6	8
UC LA	13	46	15	12
UC Santa Barbara	19	16	1	8
Caltech	10	15	9	7
Case Western Reserve	12	39	12	4
CMU	17	49	15	12
Colorado	15	52	8	7
Colorado School of Mines	15	86	12	1
Connecticut	13	37	2	4
Cornell	16	72	12	10
Florida	16	65	8	14
Georgia Tech	35	148	14	13
IIT	21	59	17	8
Illinois	12	35	3	4
Iowa State	17	55	2	4
Lehigh	20	39	6	9
Louisiana State	18	86	8	4
Mich. Tech.	14	91	9	2
Michigan	19	147	21	14
Minnesota	34	145	7	19
U Mass.	14	35	1	14
MIT	30	89	24	27
MSU	16	70	8	11
NC State	24	131	10	10
Northwestern	16	47	5	8
Ohio State	14	52	22	9
Oklahoma	13	47	6	6
Penn. State	22	105	8	19
U of Pittsburgh	23	66	14	9
Pennsylvania	16	29	14	7
Princeton	16	26	—	8
Purdue	25	149	16	20
Rice	15	36	4	15
Rutgers	17	62	5	10
Stanford	15	52	8	7
SUNY at Buffalo	13	58	11	6
Texas	23	139	13	28
Texas A&M	19	141	22	9
U of Houston	9	30	22	7
U of Washington	14	68	2	8
Wisconsin	17	96	10	15

CHEMICAL ENGINEERING PROCESS DESIGN

by Dale E. Briggs†

PROCESS design and the design of process equipment have a long history in the department. Until 1969, there were usually available a course on the general subject of process design and a second course on the design of process equipment. Prior to 1942, these courses were elective courses in the undergraduate program. Elective courses on various aspects of unit operations were also common.‡



Dale E. Briggs

In 1929–1930, ChE 23, *Design of Chemical Plants*, and ChE 27, *Design of Chemical Machinery*, were listed in the *College Bulletin*. It appeared that these courses were taken by graduate students. The only required undergraduate course touching on design was ChE 1, *Engineering Materials*. In 1934, ChE 23 became ChE 211 and ChE 27 became ChE 121. In 1937, ChE 13, *Design of Chemical Engineering Equipment* (with an emphasis on mechanical design) was added and ChE 211 was dropped. ChE 21 was also added as a one-credit-hour course for participation in the AIChE design problem. It is not known if students ever participated although the then Assistant Professor Donald L. Katz was listed as being in charge of the course in 1939–1940.

Revisions were made for the 1940–1941 academic year in which ChE 121, *Design of Chemical Machinery*, ChE 215, *Design of Chemical Plants*, and ChE 221, *Plant Location and Layout*, were listed in addition to ChE 21. Associate Professor Pettyjohn was involved with ChE 121.

Courses began being listed as Chem-Met during 1941–1944. Chem-Met 29, *Engineering Laboratory and Design*, and Chem-Met 34, *Chemical Process Design*, were listed as required undergraduate courses. This is the first time that the process-design course was identified as an undergraduate program requirement. During fall of 1943, Professors Brownell, Wood, and York were involved with Chem-Met 29 and Professor Robert White with Chem-Met 34.

Process design was not required in the graduate program until 1970–1971, but most students took the graduate course in process design to prepare for the preliminary examination for the Ph.D. program. In the early days the preliminary examination was the so-called “21-day problem.” Students had three weeks to prepare an acceptable solution to an “engineering problem,” typically similar to those covered in the graduate process-design course.

† With contributions from Phillip E. Savage.

‡ References: Engineering College *Bulletins*, 1929–1997.

*Table 21 1949–1950 Graduate
Courses Related to Process Design*

<i>Course</i>	<i>Title</i>
Chem-Met 220	Advanced Design of Process Equipment
Chem-Met 235	Petroleum Refining
Chem-Met 251	Furnace Design and Construction
Chem-Met 312	Advanced Process Design
Chem-Met 321	Plant Location and Layout
Chem-Met 335	Petroleum Refining Engineering
Chem-Met 355	Petroleum Production Engineering
Chem-Met 315	Azeotropic and Extractive Distillation

The course numbering system changed in 1946–1947. Chem-Met 29 became Chem-Met 129, Chem-Met 34 became Chem-Met 130, Chem-Met 21 was renumbered Chem-Met 101, and Chem-Met 221 became Chem-Met 321. Changes were made to the undergraduate program for 1947–1948 in which Chem-Met 121, *Design of Process Equipment*, was added as a required undergraduate course in addition to Chem-Met 129 and 130.

Several graduate courses touching on process design were listed in the 1949–1950 *Bulletin*, including those shown in Table 21. Most of these courses were tied to specific interests and experience of the faculty who were teaching them.

Beginning in 1955–1956, Chem-Met 312 was dropped and Chem-Met 220 was now called *Chemical Plants, Design Operation and Production Control*, and Chem-Met 221 was called *Equipment Design for Advanced Engineering Students*. Chem-Met 220 was renamed *Plant Process Design* in 1960–1961. While there were still mandatory undergraduate courses in process design and equipment design, there was never a *required* process design course for M.S.E. students until 1970–1971. It was at this time that the old Ph.D. preliminary examination was replaced by the preparation and defense of a proposal to embark on a specific research project.

Digital computers became available within the university in the last half of the 1950s, and had a profound impact on how things were done. Often it was the graduate students doing research that were the first to use these computers for analyzing research results and doing process-design type work. In 1959, Arthur E. Ravicz completed his Ph.D. dissertation, *Non-Ideal Stage Multi-component Absorber Calculations by Automatic Digital Computer*.

In 1959, Professors Lloyd E. Brownell and Edwin H. Young published their textbook, *Process Equipment Design*. It is considered a classic and is still being sold by the publisher forty years later.

Beginning in the academic year 1960–1961, Chem-Met 121, *Design of Process Equipment*, 129, *Engineering Laboratory and Design*, and 130, *Chemical Process Design*, were no longer required in the undergraduate chemical engineering program, but were placed into a group called “Electives in Professional Chemical Engineering Subjects,” together with several other elective courses. Typically, students completed all three courses because they were always available. In 1961–1962, Chem-Met 121, 129, and 130 became Chem-Met 480, *Design of Process Equipment*, Chem-Met 460, *Engineering Operations Laboratory*, and Chem-Met 481, *Chemical Process Design*, respectively.

A major change related to teaching process and equipment design occurred in 1961–1962 when an electronic computer course, Math 273, was required in the undergraduate program, although many of the chemical engineering undergraduates were electing the course before then. In this same period, Prof. Briggs, teaching Chem-Met 480, required his students to perform an economic design of a process condenser, in which they wrote and ran a digital-computer program for heat transfer and Prof. Briggs supplied the punched cards containing the economic-evaluation portion of the problem. Since those early days, computers have been used extensively in the process-equipment and process-design courses.

The department received a major grant from the National Science Foundation to oversee the 1964–1967 “Project on Computers in Engineering Design Education,” with Prof. Katz as director and Prof. Carnahan as associate director. The major objectives of the project were:

1. The training of engineering design teachers in subjects related to computer-aided design.
2. The study of the role of the computer in engineering design education.
3. The generation of a substantial number of completely documented computer-oriented engineering design problems.

Extensive interaction took place between our department and design teachers from several other universities, and many design problems were developed in important branches of engineering—chemical, civil, electrical, industrial, and mechanical. The project had a major impact on computer-aided design throughout the country.

In the late 1960s Professor York introduced the course *Air-Pollution Control*, ChE 449, and Professor Kempe started the course *Chemical Engineering of Water*, ChE 446. These courses were taught along the lines of process design and came at the big push in environmental concern and changes. Many of the undergraduates found jobs because of their exposure to one or both of these classes. Professor Briggs taught ChE 449 for many years after Professor York had left the department.

A major shift in the design component occurred in 1969–1970. Chem-Met 480, *Design of Process Equipment*, was dropped and replaced with Chem-Met 486, *Engineering Materials in Design*. Chem-Met 481, *Chemical Process Design*,

was dropped and replaced with two courses, Chem-Met 487, *Principles of Chemical Engineering Design*, and Chem-Met 488, *Practice of Chemical Engineering Design*. The latter course included a substantial segment on process control. Courses Chem-Met 486, 487, and 488 became required in the undergraduate program.

The Chemical & Metallurgical Engineering department split in 1970–1971 and chemical engineering courses were designated as “ChE.” In the same academic year, Chem-Met 581 and 582 were dropped and ChE 587 added. ChE 587 became a required course for the M.S.E. degree and was retained as a required course until 1986–1987, when it was dropped as a requirement and has never been offered as a course since.

The last major change occurred in 1973–1974 when ChE 488, *Practice of Chemical Engineering Design*, was dropped and ChE 466, *Process Control*, was added as a separate course. ChE 487 retained the process-design aspects of the original ChE 487 and 488 and became a four-hour course.

The use of computers in design became very common, beginning in the mid-1960s. Early on, students wrote and ran their own digital-computer programs. As software became available, there was a shift to the best available software. FLOWTRAN, developed by Monsanto, became available to the department in 1984 and was used until ASPEN was introduced in 1987. Interestingly, ASPEN was developed at MIT by Prof. Larry Evans who received his Ph.D. from our department and who also acquired his computer interest and skills at Michigan. ASPEN continues to be used in the department and is periodically upgraded when new versions become available.

Three Michigan doctoral dissertations have directly addressed computer-aided process design:

1. Luis A. Lopez, 1974 (co-chairs, Profs. Briggs and Carnahan): *DYSCO—An interactive executive program for dynamic simulation and control of chemical processes*.
2. John C. Fagley, Jr., 1984 (chair, Prof. Carnahan): *Flexibility and efficiency in modular dynamic chemical plant simulation*.
3. Nabil M. Abdel-Jabbar, 1996 (co-chairs, Profs. Carnahan and Kravaris): *Parallel simulation and state estimation algorithms for dynamic simulation on multicomputers*.

In the early 1980s, Howard Klee of the AMOCO Corporation and Ken Coulter of the Dow Chemical Company helped greatly with the teaching of ChE 487. They contributed problem statements and provided background lectures on the problems. They also attended the oral presentations given by the process-design teams. This provided a realistic industrial flavor. At the same time, an arrangement was made by Prof. Brymer Williams with Prof. J.C. Mathes of the Technical Communications Department in the College of Engineering to teach the required

technical communications class in conjunction with ChE 487. This feature improved the quality of the oral and written reports in ChE 487 while reducing to a certain degree the overall work load for the students.

In 1998, the department eliminated the requirement of a separate technical communications course. Instead, technical communication instruction was integrated within the process-design course and the laboratory classes. In process design, this integration took the form of technical communication instructors delivering about ten lectures throughout the semester, meeting with students to preview and videotape presentations, and providing constructive criticism on written design reports.

MATERIALS TEACHING

by Maurice J. Sinnott

ANY attempt to review the history of a segment of university history is bound to be incomplete and colored by the views of the writer. Such is the current effort. It represents the view of the author and covers the period from 1936 to 1997. During this period he was an undergraduate student, graduate student, and a faculty member in what was formerly the Department of Chemical and Metallurgical Engineering. In 1971 the metallurgical segment was absorbed into the newly created Department of Materials and Metallurgical Engineering (later renamed Materials Science and Engineering).

The Department of Chemical Engineering was founded in 1898 under the direction of Prof. Edward DeMille Campbell. The metallurgical component in chemistry was established in 1874. In 1922 the Engineering Research Institute was created and its chairman was Col. A.E. White, a founder of the current American Society of Metals. The University of Michigan was one of the first schools in the United States to create a department of chemical engineering, others apparently being MIT, the University of Pennsylvania, and Tulane University. These early departments were, in many respects, the breaking away of what was termed “industrial chemistry” from the traditional chemistry department. There has, however, been a strong bond between chemical engineering and chemistry that exists to the present time, and there is a constant transfer of students between these two programs at both the undergraduate- and graduate-student levels.

In some respects chemical engineering is the natural base for engineering since it deals with all materials and their manufacturing and processing. Its close association with the science of chemistry maintains a strong scientific base. Other branches of engineering are more dependent on physics.

In the 1930s and early 1940 period, the freshman year for all engineering students was prescribed and consisted of courses in mathematics, physics, chemistry,

and humanities. Essentially the only introduction to engineering were the courses *Engineering Materials*, CM 1, and *Metal Processing*, MP 2.

The engineering materials course was essentially a course in industrial processing. The manufacture of iron and steel from their raw materials was a key topic. To some extent, the non-ferrous metals—including copper alloys, aluminum alloys, bearing metals, etc.—were treated in the same fashion; The heat treatment of these materials and their fabrication into engineering structures was also covered. Cement and concrete products, plastics, polymers, and ceramics were similarly covered. The MP 2 course that accompanied CM 1 was an outgrowth of the older “shops” program that was a component of all engineering disciplines. It was primarily a laboratory course and illustrated metals techniques such as casting, forging, rolling, welding, and heat treatment. Each student for this laboratory had to purchase a ball-peen hammer, a steel rule, and a set of calipers!

As with most freshman courses, the large number of students (between 600 and 1,000) that elected the course each year more or less froze the course content and inhibited much experimentation. Lectures by senior faculty were to groups of 300–400 students and junior faculty or teaching assistants handled recitation sections in groups of 20–30 students.

The courses in the Chem-Met Department up to 1943–1944 were largely of the industrial processing type. CM 3 covered non-ferrous physical metallurgy; CM 3B taught ferrous physical metallurgy. CM 4 was inorganic technology and included topics such as salt production, ammonia, etc. CM 5 was organic technology and covered such items as petroleum processing, benzene, toluene, and similar organic materials. CM 19 dealt with the production of iron and steel and non-ferrous metals. CM 44 was the course in x-rays and diffraction analysis.

In general, each faculty member taught a graduate course in his specialty and over a period of time this material was introduced into and became part of the undergraduate courses. This is the standard way that courses develop; the numbers of the courses may not change over the years but the course content is always changing. During 1940–1945 the Chem-Met faculty convinced the curriculum committee that Chem-Met students would not have to elect CM 1/MP 2. The basis for this argument was that these students had to elect eight hours of general chemistry, eight hours of analytical chemistry, 10 hours of organic chemistry and four hours of physical chemistry and were thus better prepared to take materials courses at a higher level than the CM 1/MP 2 level. Thus was the origin of the courses CM 18 and CM 117. CM 18, later CM 118 then CM 350, was a course in the structure and properties of *solids*; CM 117 was a course on the structure and properties of *metals*.

Other departments then requested a course similar to CM 117 but tailored to their needs, leading to the development of CM 107, which became a course requirement in aerospace engineering and mechanical engineering and an elective

in several other departments. In 1950 Professor Van Vlack took over the teaching of CM 1 and introduced a series of textbooks, which revitalized the teaching of this subject and were adopted by essentially all engineering schools in the country. CM 1 was moved from a freshman-level course to the sophomore level in order to take advantage of freshman and sophomore courses in chemistry and physics. At about this same time the development of dislocation theory and the invention of the transistor had a profound effect on the teaching of the deformation of materials and the electronic properties of materials. These latest developments were immediately incorporated into the new materials courses CM 250 and CM 350 (118).

Table 22 Materials-Related Courses and Their Instructors

<i>Topic</i>	<i>Faculty Members</i>
Biomaterials	Kempe, Wang
Cast metals	Schneidewind, Rote, Flinn
Catalysis	Parravano, Gulari, Schwank, Yang
Ceramic materials	Van Vlack, Tien
Explosives	Brier, Churchill
High-temperature materials	A.E. White, Freeman, Clark, Jones
Nuclear materials	Sinnott, Was
Oxidation and corrosion	Siebert, Donahue
Plastics and polymers	Hobbs, Carrick, Filisko
Paints and protective coatings	Carrick, Hobbs, Donahue
Physical metallurgy	Upthegrove, Sinnott, Phillips, Hucke
Semiconductor materials	Mason, Fogler, Schwank

In response to the growing interest in these fields, the solid-state physics community convened a meeting at the University of Illinois—the Allerton Conference—and invited several engineering deans: Boelter of UCLA, Brown of Michigan, Walker of Pennsylvania, and Teare of Carnegie-Mellon. Dean Brown knew that I was teaching this material and invited me to join the engineering group. The physics group presented the concept that solid-state physics should be made a part of the engineering curriculum. To accomplish this they suggested that engineering students should elect more work in physics, topped off with a course in solid-state physics. Part of this presentation was a recognition on the part of physics departments that engineering schools were dissatisfied with the teaching of physics and were beginning, like Michigan, to teach their own courses. This was particularly true in Chem-Met programs with their strong backgrounds in chemistry to supply the science components that were needed. I presented the course being offered at Michigan and this essentially closed off the discussion! Most physics departments

did start to offer courses in solid-state physics but only at the graduate student level, whereas the engineering schools continued to develop materials courses at the undergraduate level.

In 1972 the design and materials work in chemical engineering was integrated into a two-course sequence, ChE 486 and ChE 487. The ChE 486 course dealt with material properties and their specification and required as a prerequisite ChE 350, the structure and properties of materials. It replaced the ChE 117 course and included such topics as the ASME codes, specifications for cryogenic and high-temperature materials, oxidation and corrosion, failure analysis and fracture analysis. The ChE 487 course dealt with chemical process design and integrated the unit operations, safety and analysis, insurance requirements, instrumentation and control.

As mentioned previously, all undergraduate courses have their origin in graduate courses and they constantly change as newer concepts and approaches are developed. The listing in Table 22 of such typical courses and the faculty who taught them indicates the range of subjects.

U–M/MSU JOINT SEMINAR SERIES—21ST ANNIVERSARY



Timothy J. Anderson, 2002

In 1982 the University of Michigan and Michigan State University initiated a joint annual seminar in chemical engineering. The seminar speaker, of national stature, is chosen jointly by the two departments and is not only honored with an individual plaque, but the speaker's name is also added to the duplicate permanent plaques displayed in each department. After the seminar there has always been a dinner for the faculty and students of both universities. The first few years we alternated between holding the seminar in Ann Arbor and East Lansing. In the late 1980s an excellent restaurant, Hunters, opened in Howell, Michigan, which is half-way between East Lansing and Ann Arbor. (How convenient!) Consequently, for the next two or three years the seminar was held in

Howell. Alas, with the closing of Hunters restaurant, we returned to the initial format of alternating between holding the seminar in the departments at the University of Michigan and Michigan State University. The 2002 seminar was given by Prof. Timothy Anderson, chairman and professor of the Department of Chemical Engineering at the University of Florida. Tim, who is editor of *Chemical Engineering Education*, spoke on "Epitaxial Deposition of Compound Semiconductors by Chemical Vapor Deposition."

*Michigan State
University*



Beaumont Tower

*University of
Michigan*



Burton Tower

*University of Michigan
and
Michigan State University*

*Present the 20th in
The Joint Seminar Series
in Chemical Engineering
Thursday, March 21*

2002 Recipient

*Professor Timothy J. Anderson
University of Florida*

Ph.D., 1979, University of California—Berkeley

Joint Lecture Series Inaugurated Winter 1982

STUDENTS ENTERING THE UNIVERSITY TEACHING PROFESSION

OUR department has had an enormous impact on chemical engineering education throughout the country, largely due to the number of our graduates who have entered the university teaching profession. Table 23 is our best estimate of our graduates so involved. Almost all the names up to 1976 were recalled so ably by Stuart Churchill at our 1998 Centennial Symposium. A very few names may be those of Michigan instructors (and not graduates) who then went elsewhere. Most of the degrees awarded (but not all) were doctorates.

Table 23 University of Michigan Graduates Who Entered Teaching

<i>Degree Year</i>	<i>Name</i>	<i>Institution(s)</i>
1886–1925		
1886	Edward DeMille Campbell	Univ. Michigan (Chemistry)
1904	Alfred H. White	University of Michigan
	Karl W. Zimmerschied	University of Michigan
1914	John Crowe Brier	University of Michigan
	Clair Upthegrove	University of Michigan
	Chester S. Schoepfle	Univ. Michigan (Chemistry)
1916	Clarence R. Smart	University of Michigan
	William Platt Wood	University of Michigan
1919	Adolph F. Wendler	University of Michigan
1920	Lee O. Case	Univ. Michigan (Chemistry)
1921	Henry L. Campbell	University of Michigan
1923	Werner Bachman	Univ. Michigan (Chemistry)
1924	George Granger Brown	University of Michigan
1926–1950		
1926	Clifford C. Furnas	Yale Univ., SUNY-Buffalo
1927	Donald F. Othmer	Poly. Inst. New York
	Reuben S. Tour	University of Cincinnati
	Clyde C. DeWitt	Michigan State University
1928	Warren L. McCabe	Univ. Michigan, Cornell Univ., PINY, NC State Univ.
	Albert B. Newman	Cooper Union
	George G. Lamb	Northwestern University
	Alfred McLaren White	NC State University

	Claude L. Clark	University of Michigan
	Wilbur L. Nelson	University of Oklahoma
1929	Marvin Carr	Wayne State University
1930	Chalmers Kirkbride	Texas A&M University
	Elmore S. Pettyjohn	University of Michigan, Cleveland State Univ.
	Carl C. Monrad	Carnegie Tech
1932	Karl Kammermeyer	University of Iowa
	Charles W. Selheimer, Jr.	University of Mississippi
1933	Donald L. Katz	University of Michigan
	Richard Schneidewind	University of Michigan
	Stuart McLain	University of Detroit
	Donald W. McCready	University of Michigan
	Henry T. Ward	Kansas State University
	James W. Freeman	University of Michigan
1934	Ralph W. Higbie	University of Arkansas
	Richard Lee Huntington	University of Oklahoma
	James D. Lindsay	Texas A&M University
	Wilbourn C. Schroeder	University of Maryland
	Clarence A. Siebert	University of Michigan
1935	Mars G. Fontana	Ohio State University
1936	Jesse Coates	Louisiana State University
1937	Robert M. Boarts	University of Tennessee
	Jesse S. Walton	Oregon State University
1938	Alan S. Foust	Univ. Michigan, Lehigh Univ.
1940	Robert M. Hubbard	University of Virginia
	George Martin Brown	Northwestern University
1941	Dysart E. Holcomb	Purdue, Univ. Texas-El Paso
	Fred Kurata	University of Kansas
	Robert R. White	Univ. Michigan, Case Western Reserve University
1942	Olaf P. Bergelin	University of Delaware
	Richard E. Townsend	University of Michigan
	Stanley Walas	University of Kansas
	Charles Weinaug	University of Kansas
1943	Frank C. Fowler	University of Kansas
	Russell Hazelton	W. Virginia Tech.
	Frank J. Lockhart	Univ. Southern California
	Albert G. Richards	Univ. of Michigan (Dentistry)
1944	James O. Osborn	University of Iowa
	Franklin B. Rote	University of Michigan

1945	Matthew van Winkle	University of Texas
	Donald R. Spink	University of Waterloo
	Ernest B. Christiansen	University of Utah
1946	Harry G. Drickamer	University of Illinois
	Kenneth O. Beatty	N. Carolina State University
	John J. McKetta, Jr.	University of Texas
	Fred H. Poettmann	Colorado School of Mines
	Maurice J. Sinnott	University of Michigan
	Edward G. Vogt	Washington State University
	1948	Cedomir M. Slipeceovich
John W. Tierney		University of Pittsburgh
Michael J. Rzasa		University of Youngstown
Lloyd E. Brownell		University of Michigan
Floyd W. Preston		University of Kansas
William Resnick		Technion (Israel)
1949		James R. Fair
	Thomas W. Leland	Rice University
	Paul H. Roy	Laval University
	George W. Govier	Univ. Alberta, Univ. Calgary
	Edwin H. Young	University of Michigan
	Gopal Tripathi	Benares Hindu University
	Brymer Williams	University of Michigan
1950	Harry Steinhauser	Rensselaer Polytechnic Inst.
	William W. Akers	Rice University
	Lyle F. Albright	Purdue University
	Julius T. Banchemo	Univ. Michigan, Notre Dame U.
	James G. Knudsen	Univ. Michigan, Oregon State U.
	Kishan B. Mathur	University of British Columbia
	Donald B. Robinson	University of Alberta
	Leonard A. Wenzel	Lehigh University
	J. Louis York	University of Michigan
	Elliott I. Organick	University of Houston, Univ. Utah (Computer Sci)

1951–1975

1951	Harold G. Donnelly	Wayne State University
	Riki Kobayashi	Rice University
	George W. Preckshot	Univ. Missouri-Columbia
	John C. Biery	Iowa State, Univ. Florida
	Peter K. Lashmet	Rensselaer Polytechnic Inst.
	John E. Powers	Univ. Oklahoma, Univ. Michigan

	Kamal Asgar	Univ. Michigan (Dentistry)
	Donald N. Frey	Northwestern (Bus. Ad.)
	Jacob M. Geist	MIT, Technion (Israel)
1952	James P. Kohn	University of Notre Dame
	John E. Myers	Purdue University, Univ. Calif. Santa Barbara
	David Cornell	Mississippi State University
	Seymour Calvert	Case Western Reserve Univ.
	Murray M. Gilkeson	Tulane U., Harvey Mudd College
	Stuart W. Churchill	Univ. Michigan, Univ. Pennsylvania
1953	Philip E. Bocquet	University of Arkansas
	Richard Kraybill	University of Rochester
1954	Buford D. Smith	Washington University
	Imre Zweibel	Arizona State University
	Thomas S. Heines	Cleveland State University
	Leonard M. Naphthali	Poly. Inst. New York
1955	Charles M. Thatcher	Univ. Michigan, Univ. Arkansas
	Lawrence A. Warzel	Univ. Oklahoma (Pet. Eng.)
	Robert D. Pehlke	University of Michigan
1956	Charles A. Sleicher, Jr.	University of Washington
	Russell B. Mesler	Univ. Kansas (Nuc. Eng.)
	Howard R. Voorhees	University of Toledo
1957	Robert C. Ackerberg	Poly. Inst. New York
	Alberto E. Molini	University of Puerto Rico
	Donald L. Stinson	University of Wyoming
	Peter H. Abbrecht	Univ. Michigan, Univ. Uniformed Services (Medicine)
	Bert K. Larkin	University of Denver
	Morton P. Moyle	Lehigh University
1957	Martin E. Gluckstein	Wayne State University
	William R. Upthegrove	Univ. Texas, Univ. Oklahoma
	Henry C. Lim	Purdue University
	William R. Martini	Washington State University
1958	George A. Coulman	Cleveland State University
	Lowell B. Koppel	Purdue University
	Donald W. Sundstrom	Univ. Cincinnati, Univ. Connecticut
	Ronald E. West	University of Colorado
	Richard S. Mayer	Ohio University
1959	Noel H. De Nevers	University of Utah
	W.J. Murray Douglas	McGill University
	George H. Miley	Univ. Illinois (Nuc. Eng.)

1960	Herbert Klei John C. Angus William W. Graessley Irving F. Miller	University of Connecticut Case Western Reserve Univ. Northwestern Univ., Princeton Univ. PINY, Univ. Illinois-Chicago, Akron University
1961	George T. Tsao William R. Wilcox Richard E. Balzhiser John C.-C. Chen Morton H. Friedman Jesse D. Hellums Gary K. Patterson Fred P. Stein Howard F. Silver Paul Trojan Peter B. Lederman Guy C. Berry	Iowa State U., Purdue University Univ. Southern Calif, Clarkson Univ. University of Michigan Lehigh University Johns Hopkins, Ohio State Univ. Rice University Univ. Arizona, Univ. Missouri-Rolla Lehigh University University of Wyoming University of Michigan-Dearborn PINY, NJIT Carnegie-Mellon Univ. (Chemistry)
1962	Lawrence B. Evans Robert H. Kadlec David P. Kessler W. Leigh Short Millard L. Jones	MIT University of Michigan Purdue University University of Massachusetts University of Toledo
1963	C. Phillip Colver Fred D. Otto Robert G. Squires Jude T. Sommerfeld Robert D. Tanner James O. Wilkes James R. Street John Verhoeven Philip A. Rice Benson P. Shapiro Gary F. Bennett	University of Kansas University of Alberta Purdue University Georgia Institute of Technology Vanderbilt University Univ. Cambridge, Univ. Michigan University of Michigan Iowa State University Syracuse University Harvard Univ. (Medicine) University of Toledo
1964	Alan J. Brainard Thomas J. Schriber John M. Dealy W. Nicholas Delgass Yatish T. Shah Lester S. Kershenbaum	University of Pittsburgh Univ. Michigan (Bus. Ad.) McGill University Purdue University Univ. Tulsa, Univ. Pittsburgh, Drexel University Drexel University, Imperial College (London)

1965	Brice Carnahan	University of Michigan
	Robert E. Barry	Univ. Michigan, Lawrence Tech. Univ.
	D. Grant Fisher	University of Alberta
	Richard A. Grieger	University of Wisconsin
1966	John B. Edwards	University of Detroit
	Ching-Rong Huang	NJIT
	Dudley A. Saville	Princeton University
	Warren D. Seider	University of Pennsylvania
	Michael R. Samuels	University of Delaware
	Richard G. Donnelly	George Washington University
1967	Alan E. Mather	University of Alberta
	Gary J. Powers	Carnegie Mellon University
	Stacy L. Daniels	University of Michigan (Adjunct)
1968	Robert L. Bratzler	Princeton University
	Dale E. Briggs	University of Michigan
	Joseph D. Henry	U. West Virginia, Arizona State U.
	Victor F. Yesavage	Colorado School of Mines
	Donald Harvey	Cleveland State University
	George Quarderer	U-M Extension Program, Midland
1969	Fredric G. Bader	University of Michigan
	Francis Verhoff	University of Notre Dame
1970	Charles A. Weinberger	Drexel University
	N. Lawrence Ricker	University of Washington
1971	Norman F. Roderick	University of New Mexico
	Thomas L. Schwenk	Univ. Michigan (Medicine)
1972	John P. Duffy	University of Western Ontario
1974	Larry M. Joseph	University of Illinois-Chicago
	Frederick E. Weber	University of Tennessee
	Peter E. Parker	Western Michigan University
	Andre W. Furtado	Wayne State University
1975	T. Michael Duncan	Cornell University

1976–2002

1976	James G. Goodwin	Univ. Pittsburgh, Clemson Univ.
	Gerald D. Holder	University of Pittsburgh
	John C. Crittenden	Michigan Tech. University
1978	William H. Talbott	Clemson University
1981	David E. Guinnup	University of North Carolina
	Kartic C. Khilar	IIT Bombay
1982	Khashagar Aminian	University of West Virginia
	Abdul Al-Tamimi	JUST, Jordan

1984	Gregory F. Payne	Univ. Maryland, Balt. Co.
	Abhaya K. Datye	University of New Mexico
1985	Jim Y. Lee	Natl. Univ. of Singapore
	Steven LeBlanc	University of Toledo
	K.Y. Simon Ng	Wayne State University
1986	Levi T. Thompson	University of Michigan
	Robert L.-H. Lee	New Mex. Inst. Mining & Tech.
1987	Kevin McKeigue	City College of New York
1988	Rosemarie W. Williams	Louisiana State University
1989	Ananth Annapragada	Cleveland State University
	Georgios Georgiou	National Tech. Univ. of Athens
	Themis Matsoukas	Penn State University
	Kristen Fichthorn	Penn State University
1990	R. Dennis Vigil	Iowa State University
1991	Douglas Hayes	Univ. Alabama Huntsville
	Prodromos Daoutidis	University of Minnesota
	Jay D. Keasling	Univ. California-Berkeley
	Joanne M. Belovich	Cleveland State University
1992	Srinivas Palanki	Florida A&M U, Florida SU
	Jeong-Gil Choi	Hannam Univ., Korea
	Masoud Soroush	Drexel University
	Alexander Couzis	City Univ. of New York
1993	Joseph P. Greene	Calif. State Univ., Chico.
1994	James R. Brenner	Florida Inst. of Technology
	Choul-Gyun Lee	Inha Univ. (Korea)
	Manos Mavrikakis	University of Wisconsin
	Patricia A. Relue	University of Toledo
1995	Ching-An Peng	Univ. of Southern California
1996	Nabil Abdel-Jabbar	Jordan Univ. Sci. & Tech.
	Stelios T. Andreadis	SUNY Buffalo
	Karsten E. Thompson	Louisiana State University
1997	Nikolaos Kazantzis	Texas A&M University
	Lonnie D. Shea	Northwestern University
1998	Heock-Hoi Kwon	Songsil Univ., Korea.
1999	Byung-Soo Kim	Han Yang Univ., Korea
	Dong-Shik Kim	University of Toledo
	Pomthong Malakul	Chulalongkorn Univ., Thailand
2001	Cattaleeya Pattamaprom	Thammasat Univ., Thailand
	Artiwan Shotipruk	Chulalongkorn Univ., Thailand
2002	Akkarat Manasilp	Burapa Univ., Thailand
	Sutawadee Chitprasert	Kasetsart Univ., Thailand

Early Evolution of Computers at the University of Michigan

THE nature of computing activities *within* the department has very much been influenced by hardware and software available *outside* the department, particularly during the period 1955–1985.† Thus, to gain perspective on the computing scene in chemical engineering, it is appropriate to examine both the history of the University of Michigan Computing Center, which housed successive *centralized* mainframe machines, and the subsequent College of Engineering Computer-Aided Engineering Network (CAEN), which specialized in *distributed* computing. Note, however, that the first use of a digital computer by one of our doctoral students was that of the ENIAC at the Aberdeen Proving Ground by Roland O. Gumprecht, who worked in the area of light scattering. Gumprecht published his doctoral dissertation, *Determination of Particle Sizes in Smokes* in 1953, as detailed in the article “Another Michigan Chemical Engineering First,” by Cedomir M. Sliepcevic, on page 323.

Until the early 1980s, the electronic digital-computing resources available to the department were essentially those at the central U–M Computing Center. The scene from the early 1950s until 1971 is particularly well described in *The University of Michigan Computing Center* brochure of October 1971, from which much of this section is adapted.

The MIDAC. The success of the early electronic machines built elsewhere—particularly ENIAC (Electronic Numerical Integrator and Computer) and one of its successors—SEAC (Standards’ Eastern Automatic Computer), the National Bureau of Standards’ machine—led the University of Michigan Willow Run Laboratories to design and build a hopefully improved but somewhat unsuccessful machine, MIDAC (Michigan Digital Automatic Computer‡), which, with its mercury

† This chapter was compiled by Jim Wilkes, who gratefully acknowledges the following sources: (a) the brochure *The University of Michigan Computing Center*, edited by Mary Ann Wilkes and published by the Computing Center for the dedication of their new building on North Campus in October 1971, (b) Brice Carnahan’s two-part article “Computing in Engineering Education,” published in the fall 1991 and winter 1992 issues of *Chemical Engineering Education*, (c) Peter Lederman’s recollections of the Ford Foundation Project, and (d) personal recollections of Brice Carnahan and Bernard Galler. The reader is also referred to an excellent summary, *A Brief History of Computing in Chemical Engineering*, written by J.D. (“Bob”) Seader, when he was the recipient of the 20th Donald L. Katz Lectureship at the U–M in April 1990.

‡ The MIDAC acronym was sometimes uncharitably taken to mean “Machine is Down Almost Continuously.”

delay-line storage, became operational in 1952. The machine was used primarily for sponsored research, but some student use was arranged. U–M mathematics faculty member Prof. John W. Carr, III, was an early proponent of MIDAC, and offered an introductory computing course in fall 1953.

The first ChE student to use MIDAC was Ronald Crozier‡, who performed calculations for the AIChE Distillation Tray Efficiency Project. Although it was a large machine at that time, MIDAC was extremely small and slow by present standards, and the electronic technology of the period was barely adequate to permit a minimal level of reliability. Working under the supervision of Brymer Williams, Crozier published his Ph.D. dissertation, *Froth Stratification and Liquid Mixing in a Bubble Tray Column*, in 1956.



News & Information Services, Box A-11, Bentley Historical Library, U–M

MIDAC computer at the U–M Willow Run Laboratory.

In this same era, in 1952, the U–M also acquired one of the first commercial computers—an early blend of mechanical punched-card equipment and electronic arithmetic circuitry produced by IBM and called the *Card Programmed Calculator* (CPC). This machine was installed in the unit that then handled administrative and statistical services, the “Tabulating Service.”

The IBM 650 computer. The use of these diverse facilities further increased the faculty and staff awareness of the potential impact of computing and, when IBM made a reliable, intermediate-size computer (the Model 650) readily

‡ Brymer Williams, whose memory is nigh infallible, recalls the full name: Ronald David George Crozier, whose English father was superintendent of a copper mine in Antofagasta, N. Chile. Ronald Crozier had completed his undergraduate degree at the University of Glasgow, and came from Chile to the U–M, where he completed his doctorate in chemical engineering.

available to universities in 1956, one was installed in the Statistical Research Laboratory, a unit of the Horace H. Rackham School of Graduate Studies.



Nov. 1957 ChE graduate booklet

One-up on the slide rule. Research assistant Marvin L. Katz uses a Monroe electro-mechanical calculator in the chemical engineering “computing room” for finned-tube research.

In a sense—since it was on the campus—this machine really marked the beginning of the present era, and was used by students in the offerings of the U–M’s introductory computing course (Math 73), taken by Jim Wilkes when first taught by Prof. Bernard A. Galler in winter 1956, and by Brice Carnahan soon afterwards. Here is a picture of what students did during that year:

- Each of us learned to operate the computer and then signed up for—at most—one hour per week to solve our problems.
- The IBM 650 had no keyboard or printer—just a card reader and a card punch. All communication was through punched cards or directly with keys on the console (the lights displayed information in *biquinary* format—you might want to look that one up!).
- All programming was in the machine’s language; each operation code contained an operation code plus two addresses, one for an operand and another for locating the next instruction in the memory.
- The “operating system” consisted of a four-card machine-language loader. Program execution could be initiated, interrupted, or stepped one instruction at a time, directly from the console; the light pattern on the console was the

only feedback available to the programmer/operator, and the repeated light patterns from infinite loops were fascinating to watch (although, of course, we *never* had any of those ourselves).



News & Information Services, Box B-1, Bentley Historical Library, U-M

The IBM 650 (left and rear), the Computing Center's first machine, in the basement of the Rackham Building. Students signed up to reserve time on the machine, and then they operated it themselves, but only between 8 and 5 o'clock and "never" during lunch hours or on weekends. But, however much computing may have changed, student ingenuity seems to have remained much the same. Those who used the 650 quickly discovered the window (at the rear), and began letting one another in to use the machine after hours. Professor Bernard A. Galler, who started a long and distinguished career in computer science at the U-M in 1955, is operating the punched-card input/output machine at the right.

- The IBM 650 had a rotating-drum memory with 50 memory cells arranged in each of 20 "cylinders" around the drum surface, with sets of three read/write heads spaced 120° apart. Because of the time required for interpreting and processing an instruction, placement of both the data and the next instruction was critical for efficient execution. The location of each program instruction and data item on the drum had to be considered carefully, since a drum is not a random-access device. How do you think a current U-M student working on

a Macintosh would respond to the following directions?

“If the instruction address is an *even* number, the *data address* should be three word positions later (on any cylinder) and the next *instruction address* should be four word positions beyond that. Since there are 50 word positions around the cylinder, the correct drum rotation angle for the next instruction is 50.4° If the instruction address is *odd*, the data address should be three word positions later and the next instruction address should be five positions beyond that, so the drum rotation angle for the next instruction is 57.6° .”

- Fortunately, the SOAP (Symbolic Optimal Assembly Program) assembler arrived and relieved us of the drudgery of calculating all those nasty drum positions. That was *real* living!
- MITILAC was used on the IBM 650—it was an interpretive program (MIT Instrumentation Laboratory Automatic Computer) that solved systems of ordinary differential equations.



Paul Jaronski

Brice Carnahan and Robert Bartels, 7 Oct. 2000.

- About late 1957, spurred by general interest in the use of a symbol-oriented assembly language, GAT (Generalized Algebraic Translator) became available. Written by Robert M. Graham and Bruce W. Arden of the U–M Statistical Research Laboratory, and Bernard A. Galler of the Mathematics Department, GAT consisted of an algebraic language and its associated assembler, with symbolic names for operation codes and addresses, but still leaving the drum-angle determination to the programmer. The resultant relative ease of programming greatly enlarged the user population on the U–M campus and at other universities where the language was used.
- As an independent assignment in Math 73, Brice Carnahan chose to solve the

two-dimensional heat-conduction problem in an L-shaped section of a furnace wall, governed by Laplace's equation, $\nabla^2 T = 0$.

The Computing Center



Robert C.F. Bartels

Strong interest in the IBM 650 soon demonstrated the feasibility of using it to solve many classroom problems, and it was quickly apparent that the combined demand for research and instructional computing greatly exceeded the capability of the machine. Therefore, in 1959, the computing service and development functions of the Statistical Research Laboratory were transferred to the newly created Computing Center, which occupied a portion of the bottom floor of the North University Building. Professor Robert C.F. Bartels was the first director of the Computing Center, a position he held until his retirement in 1978. A native of Brooklyn, he had been a member of the mathematics faculty since 1938, when he received a doctorate in mathematics from the University of Wisconsin. His professional interests were in the application of mathematics to elasticity, hydrodynamics, and numerical analysis.

During World War II, Prof. Bartels served as an aero engineer with the Navy Department. It was during a sabbatical leave in 1954 at the Oak Ridge Institute of Nuclear Studies that he first became involved with digital computers, using them for numerical studies of magnetohydrodynamic instability. His qualities as a teacher are perhaps best expressed in the words of a former student, later a professor at the U–M: “He [Bartels] was an exceptionally gifted lecturer, his presentations being noteworthy for their clarity and careful attention to detail. In my whole career as a student, he stood out as one of that small handful of teachers that I can genuinely call outstanding.”

The IBM 704 and 709 computers. The machine that replaced the 650 in the new Computing Center in September 1959 was an IBM 704 with 8,192 words of storage in main magnetic-core memory and the first to have a built-in floating-point unit. This machine came with the first commercial version of FORTRAN (FORTRAN–II), which accommodated *subprograms* (main program, functions, and subroutines). Although the IBM 704 was in the “large” category, used in many installations throughout the country, it was not, in general, used with operating systems for automatic batch-job processing. Also, the programming languages available for the system had many shortcomings. As a result, the Computing Center staff quickly elaborated upon the rudimentary compiler and operating system whose use had become an established pattern during the 650 period, indeed, a necessity for a large user population. The early versions of the

executive system were produced in cooperation with the General Motors Technical Center, which was working on similar developments. The results of these efforts were:

1. The MAD (Michigan Algorithm Decoder) language and compiler, authored by Bruce Arden and Bob Graham, assisted by Bernard Galler.
2. The UMES (U-M Executive System) operating system, which although based on the General Motors operating system, involved rewriting about 90% of the GM system, a task undertaken by Bernard Galler.



IBM 704 computer at the Computing Center in the North University Building Station (NUBS). Bruce W. Arden is with the printer (left) and Bernard A. Galler sits at the console (right), with tape drives in the background. NUBS was demolished in 2002 to make way for a new Life Sciences Building.

These additions made it possible to provide flexible computer service to an increasingly large fraction of the students and staff. In fact, the system was necessary for the success of a large College of Engineering project that was started in 1959 and had a major impact on computing at Michigan. At the U-M's request, the Ford Foundation provided funds to the college so that faculty could be given release-time to learn about digital computing, computer-solvable problems could be assigned in regular engineering courses, and specific course curricula could be developed that exploited the powerful problem-solving capabilities of such a system. This three-year project provided a solid base of computing experience and expertise in the College of Engineering and gave the U-M a significant head start in the instructional use of computers.

The growing competence of the users and the widening spectrum of use led to the need for a greater variety of peripheral storage and input/output devices, with a concomitant increase in complexity of the controlling programs. In October 1961, the IBM Model 709, which had been installed at Willow Run Laboratories for a short period of time, was transferred to the Computing Center to replace the Model 704. This successor machine had connected to it independent, specialized computers, called *channels*, which managed the peripheral equipment. As a result, the operating system was complicated by the need to manage a number of simultaneously operating devices—a preview of things to come. This system augmentation placed the university in a good position to capitalize on the transistorized version of the machine, the IBM 7090, which was installed in September 1962.

The MAD Programming Language

In support of the 1958 ALGOL effort, the Computing Center started to try to implement 1958 ALGOL, to see what difficulties it introduced into language development. The 1958 ALGOL committee had announced that they would meet again in 1960 to listen to what was learned in the interim. The Computing Center found that there were several features specified in 1958 ALGOL that were either too hard to implement, impossible to implement, or too inefficient when done. Bruce Arden, Bob Graham, and Bernard Galler changed the language in each of these areas, so as to get something working, and by the time they were finished, they believed that it was too far from 1958 ALGOL to be called by that name, so they thought up their own name—MAD (Michigan Algorithm Decoder). MAD first began working correctly in about February 1960, and was initially implemented on the IBM 704.

MAD was at least ten years ahead of FORTRAN in its structure, sophistication, and simplicity, and the following were some of its features:

1. It allowed a complete range of Boolean expressions.
2. In addition to formatted input and output, simplified I/O statements were also permitted. For example, `PRINT RESULTS A, X(5) . . . X(10)` would print not only the values of the variable `A` and six elements of the array `X` using appropriate fields, but would also clearly identify what was being printed.
3. Its `WHENEVER`, `OR WHENEVER`, `OTHERWISE`, and `END OF CONDITIONAL` statements allowed great flexibility of conditional structures, anticipating by many years the `IF`, `ELSE IF`, `ELSE`, and `END IF` statements of FORTRAN-77.
4. Recursive functions were allowed

Apart from the first two lines, which have been added to show column alignments, Table 24 is the listing of a complete MAD deck of punched cards, in which the first two identification cards were yellow, specification cards (starting with a

dollar sign) were blue, and the rest had the usual pink stripe at the top! The last three numbers of the identification cards specified a maximum execution time of five seconds, no more than five pages of output, and zero cards to be punched on output. All letters were upper-case only.

Table 24 A Sample MAD Program, with Control Cards and Data.

```

          1          2          3          4          5          6
123456789012345678901234567890123456789012345678901234567890123456
DONALD LAVERNE KATZ          D066N          *05 005 000
DONALD LAVERNE KATZ          D066N          *05 005 000
$ COMPILE MAD, EXECUTE, DUMP, PRINT OBJECT

R MAIN PROGRAM THAT CALLS ON EXTERNAL FUNCTION CALC,
R WHICH FINDS THE MEAN OF THE N VALUES X(1)...X(N)

INTEGER N
BOOLEAN CALC., NEGTV
DIMENSION X(100)
START READ AND PRINT DATA N, X(1)...X(N)
      NEGTV = CALC.(N, X, MEAN)
      PRINT RESULTS N, X(1)...X(N), MEAN, NEGTV
      TRANSFER TO START
      END OF PROGRAM

$ COMPILE MAD, PRINT OBJECT

R CALC. RETURNS AS ITS VALUE THE BOOLEAN CONSTANT 1B
R (TRUE) OR 0B (FALSE), DEPENDING ON WHETHER OR NOT THERE
R IS AT LEAST ONE ELEMENT OF THE ARRAY Y THAT IS NEGATIVE.

EXTERNAL FUNCTION (N, Y, AVG)
INTEGER N, I
BOOLEAN NEGTV
ENTRY TO CALC.
AVG = 0.
NEGTIV = 0B
THROUGH LOOP, FOR I = 1, 1, I.G.N
AVG = AVG + Y(I)
LOOP  WHENEVER Y(I) .L. 0., NEGTV = 1B
      AVG = AVG/N
      FUNCTION RETURN NEGTV
      END OF FUNCTION

$ DATA
N = 4, X(1) = 2.45, 0.00447, -12.33, 4.50 *
N = 3, X(1) = 1.332E-4, 0.00476, -21.3E-5 *
```

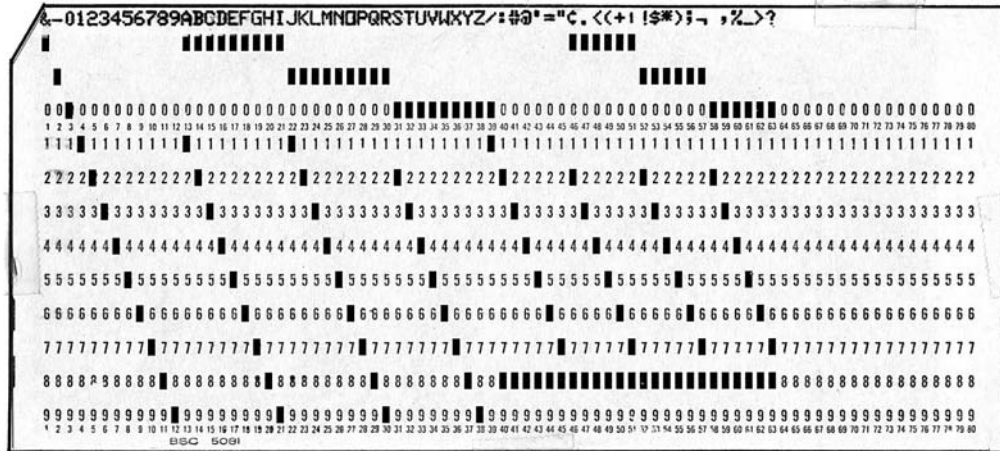

A punched card with the holes shown in black. A total of 63 characters (printed at the top) could be represented, each needing either a single, double, or triple punch in its column. The punched card was the main source of significant program input at the University of Michigan until 1982.

An Important Analog Computing Facility

The Applied Dynamics (an Ann Arbor company) model 16-PB analog computer was a significant addition to the computing facilities of the department for solving sets of non-linear, ordinary differential equations. Perhaps the most common student demonstration was the solution of the second-order, ordinary differential equation that described the dynamic response of a simple mass-spring-damper (MSD) system. In “repetitive operation mode,” the analog computer would produce a continuous solution that could be displayed in a fraction of a second on an oscilloscope. The user could change system parameters (such as the amount of damping in the MSD system) by adjusting the setting of the appropriate potentiometer (center of accompanying photograph). As the parameter (damping) was changed, the effect on the dynamic response was displayed “instantly” and the student could reproduce the complete range of MSD-responses from “over-damped” to “oscillatory” with the turn of a single dial. This demonstration was much faster and more effective for teaching purposes than calculating digital solutions on the university’s new IBM 7090 computer, which required a deck of punched cards that was usually processed overnight. It also gave the students some experience with basic electrical engineering since they had to design an appropriate electrical circuit to solve their problem; also, each of the up to 16 amplifiers (being adjusted at top of photo), up to 20 potentiometers (center of computer), and resistors, etc., had to be interconnected individually by inserting a “patch cord” into the appropriate “hole” on the removable patch-board (center, bottom).

After completing an analog computer simulation of, say, a liquid-level control

process in the department's Process Dynamics and Control Laboratory, the students could proceed to an experimental investigation of the same system using the actual pilot-plant equipment.

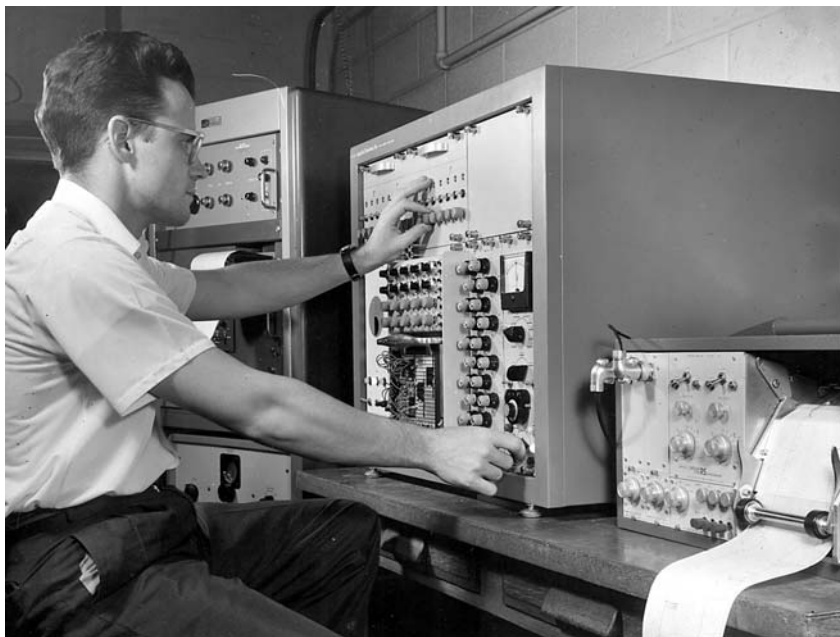

U-M Chem/Met graduate booklet, Dec. 1963

D. Grant Fisher (Ph.D. 1965) using the Applied Dynamics analog computer, which was one of the key additions to the 1963 expansion and upgrade of the department's Process Dynamics and Control Laboratory in the East Engineering Building.

For more advanced “hybrid” applications, the electronic industrial measurement sensors and control valves on the new pilot plants could be interfaced directly to a user-designed controller programmed on the analog computer and run in real time. Although it seems primitive from today's perspective, these hybrid computer applications could not be done at that time with student-programmable digital computers, and represented the beginnings of real-time, sensor-based, user-designed computer control applications.

The IBM 360/67 Computer

The impact of the “computer revolution” on university instruction and research became increasingly evident with the second generation of computers. Machines with the features necessary to handle this diverse and very demanding computing load were, in 1964, in the early design stage. The Computing Center solicited proposals of suitable design from three vendors, after which a variant

of the then-new IBM System 360 series of computers was selected. This system, which became known as the Model 67, looked attractive to many universities, but the time from conception to successful exploitation of the new features proved to be longer than anticipated. When IBM's own efforts to provide operating-system support for this novel configuration were delayed, the Computing Center was able, because of its earlier system development expertise and some experience with multiple-use programs on a small System 360 machine acquired to support the 7090 system, to start to develop an operating system that came to be known as MTS (Michigan Terminal System).

From its beginning in mid-1966 on the small support machine, MTS continued to improve in performance and ease of use over a 20-year period. In January 1967 a single-processor Model 67 was installed. In November of the same year, systems programs using the virtual-memory features became operational, with a dramatic increase in the number of computing tasks that could be handled “simultaneously.” Individual programs were assigned short “time-slices” of processor use in round-robin fashion. In August 1968, a second processor and additional storage were added to the system—more than doubling its capacity. In the succeeding years, additional file storage, remote-entry batch stations, and interactive terminals were added until the system reached its configuration that existed at the time of the move to North Campus in October 1971. MTS, which continued to evolve over the ensuing years, was unique in that it provided an incredibly stable mainframe computing environment until it was eventually phased out in the mid 1990s.

Since in some sense 1971 was in the middle of the “Golden Age” of the University of Michigan Computing Center, it is worthwhile recalling the equipment that was installed there in 1971.†

1. Two IBM 360/67 *central processors*. Instruction times for each processor were of the order of one microsecond. The control unit of each processor partially decoded several instructions in advance of the one actually being executed.

2. Six magnetic-core memory units or *memory boxes*, each subdivided into 64 parts of equal capacity called *pages*. Each page contained 4,096 bytes, or the equivalent of 1,024 full words of memory. Thus, there was a total of 384 pages or somewhat more than 1.5 megabytes of fast memory. The fetch and decoding time for an instruction word was about 750 nanoseconds (billionths of a second).

3. Two high-speed *drum memories*, shared by the two 360/67 processors. Each drum had a capacity of 900 pages of 4,096 bytes each, giving a total drum store of 7,373,800 bytes.

4. Three IBM 2314 *disk files*. Each file had eight disk drives equipped with removable disk packs, each of which had a storage capacity of approximately 29 megabytes, for a total of about 700 megabytes.

† Reproduced, with permission, from Brice Carnahan and James O. Wilkes, *Digital Computing and FORTRAN IV with MTS Applications*, published by the authors, Ann Arbor, Michigan, 1971.

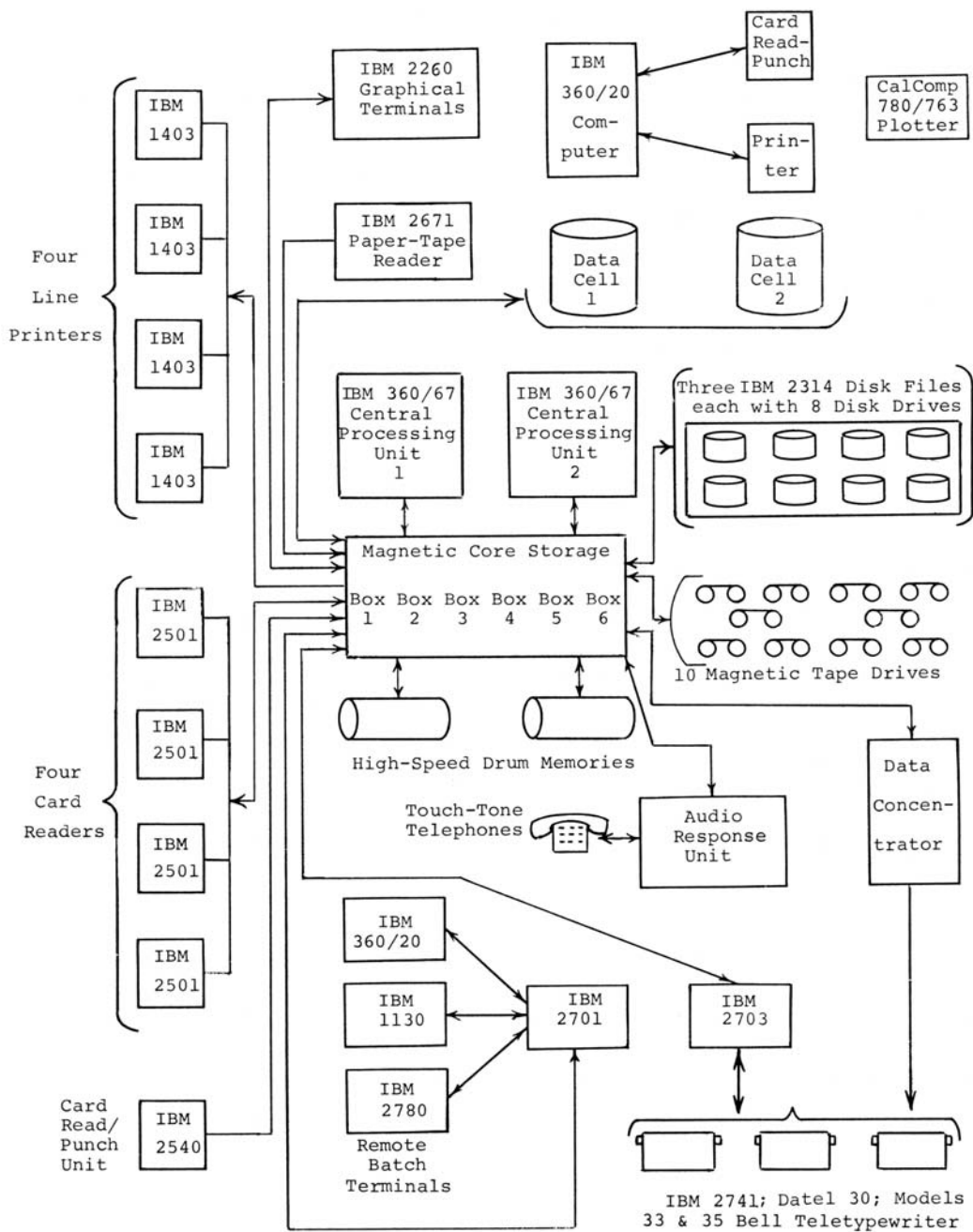

Configuration of the IBM 360/67 computing system at the U-M, 1971.

5. Two *data cells* containing magnetic strips on which information could be written or read, for a total capacity of 800 megabytes.

6. Ten *magnetic tape drives*, eight of which were equipped to handle 9-track tapes (standard for the IBM 360 system, and two to accommodate 7-track tapes (the standard for older IBM computers).

7. Four IBM 1403 *line printers*, each of which had a maximum printing speed of 900 lines per minute, with a carriage width of 132 columns.

8. Four IBM 2501 *card readers*, each with a maximum reading speed of 1,000 cards per minute.

9. One IBM 2540 *card read/punch unit*, with a maximum reading speed of 1,000 cards per minute and a maximum punching speed of 300 cards per minute.

10. One IBM 2671 high-speed *paper-tape reader*, which could read 5-, 6-, 7-, or 8-channel paper tape.

11. One *audio-response unit*, which could generate audible (and intelligible!) sounds under computer control for transmission over the telephone network. It could also accept input signals from the tone generators of a touch-tone telephone.

12. One IBM 2701 *communications terminal*, which could accept synchronous signals from computers or other devices over the standard telephone network. Its primary role was to serve as the communications link between the IBM 360/67 system and small IBM computers or IBM 2780 terminals that allowed the entry of batch jobs on cards at remote locations. It could also send line images from the central computer to the remote computing facilities for printing.



James Wilkes

Model 35KSR teletypewriter, third floor, East Engineering.

13. One IBM type 2703 *communications terminal*, which could handle asynchronous signals (arriving at arbitrary times) from as many as 48 voice-grade

telephone lines in half-duplex mode. This unit was the principal communication device between the IBM 360/67 system and remote time-sharing terminals—in particular, the IBM 2741 and 1050 terminals, the Model 33 and 35 Bell teletypewriters, and the Friden and Datel terminals.

14. One *data concentrator*, which was a modified PDP-8 computer that could service 16 telephone lines in full-duplex mode (send and receive simultaneously). The data concentrator could communicate directly with either of the central processors, and could service a variety of terminal devices, including the IBM 2741, Model 33 and 35 Bell teletypewriters, and small digital computers.

15. Two IBM 2260 *graphical terminals*, each with a typewriter-like keyboard and a television screen for character display.

16. One IBM 360/20 *computer*, for preparing printed listings of punched cards and for reproducing and interpreting card decks.

17. One Calcomp 780/763 *digital plotter*, an off-line device that could record graphical information (from magnetic tape prepared by the IBM 360/67 computer) on 30-inch plotting paper.

18. One DEC-338 and one DEC-339 *graphical processor*, being stand-alone computers for manipulating graphical information (with cathode-ray display) that could operate in time-sharing mode with the IBM 360/67 computing system. Information could be entered by various devices, including a “light pen” that allowed the user to “draw” on the face of the TV-like screen.

A typical FORTRAN batch job from this era follows. In this context, the pseudo-device names *SOURCE* and *SINK* meant the card reader and line printer, respectively. The logical input/output units SCARDS, SPRINT, and SPUNCH referred respectively to the source of the input card images, the destination of the output print lines, and the destination of the output card images (in this case, to a file).

```
$RUN *FORTRAN SCARDS=*SOURCE* SPRINT=*SINK* SPUNCH=OBJFILE
```

(Punched cards with the FORTRAN program)

```
$ENDFILE
```

```
$RUN OBJFILE MAP 5=*SOURCE* 6=*SINK* T=10 P=20 C=0
```

(Punched cards with the input data)

```
$ENDFILE
```

By 1976, the IBM 360/67 computer had been replaced with an Amdahl 470V/6 machine, which used large-scale integrated circuitry and air cooling. Its central processor had a cycle time of 32.5 nanoseconds and instruction times varying from 65 nanoseconds to about one microsecond. On average, several million instructions could be executed per second. External communication devices were becoming more sophisticated and with increasing capacities. For example, the Memorex 1270 transmission controller could accommodate up to 52 devices over voice-grade

telephone lines operating with asynchronous signals at data transmission rates of up to 1,200 baud (bits/second) and up to 12 devices operating over high-capacity lines with synchronous signals at transmission rates of up to 9,600 baud. The three data concentrators could handle a wide variety of remote devices in full-duplex mode over approximately 120 telephone lines. There were remote batch stations in the North University Building on the Main Campus (“NUBS”), at the Flint Campus, and at the Dearborn Campus.

In subsequent years, more powerful mainframe computers were in use at the indicated dates (although the exact year of installation may be slightly earlier): 1979, Amdahl 470V/7; 1984, Amdahl 5860; 1986, Amdahl 5860 and Amdahl 470/V8; 1987, IBM 3090-400; 1991, IBM SE9000-720 (with six central-processing units, each with a main random-access memory of 256 megabytes, a cycle time of 14.5 nanoseconds, individual machine instruction times varying from 14.5 to about 150 nanoseconds, and executing about 30 million machine instructions per second). By 1994, the days of a central mainframe computer for everyday use in the College of Engineering were over and MTS was phased out shortly afterwards.

Donald Katz’s Two Pioneering Digital-Computer Projects

The Ford Foundation project. By the late 1950s, some research projects, particularly those depending on intensive computation such as the finite-difference solution of partial differential equations, had started to use first the IBM 650 and then the IBM 704 computers. However, problems assigned in courses still depended primarily on the slide rule for numerical solutions.



Donald L. Katz

have on engineering practice. He convinced the Ford Foundation to support a

Prof. Donald L. Katz had the foresight to recognize the rapidly growing potential of digital computers in *all* walks of engineering, and—in typical fashion—decided to do something about it. Indeed, the early 1960s were to become a crucial period for introducing students and faculty to new computational methods and the blessings and curse of the digital computer. Students had to recognize and identify the computational logic that had previously come to them inherently without really thinking about it. Thus, clear analysis was now required and this, of course, became an additional benefit in learning and teaching. In 1959, Donald Katz (then chairman of the Department of Chemical and Metallurgical Engineering) fore-

\$900,000 feasibility study of broad-scale integration of computer use into undergraduate engineering curricula that would make recommendations, prepare teaching materials, and train faculty.

Grants were made available for people both at Michigan and other universities throughout the country, who would come to Ann Arbor to participate in the Ford Foundation project. All these people developed problems that would illustrate the various uses of computers in engineering problems and their solutions, enabling students to play the “what if?” game, which is so common today, but which was really not done in the 1950s. Slide rules and comptometers were the common tools of the trade, but options and sensitivity analysis were a rare thing, because it was just too time consuming with the traditional tools.



Nov. 1961 ChE graduate booklet

Graduate student Stanley C. Jones using the Ford Foundation Project Bendix G-15 computer to solve reservoir engineering problems involving unsteady-state flow of water in porous beds.

In a four-year period, over 200 faculty from nine engineering disciplines and 65 engineering schools participated in the various activities of the Michigan project; they jointly produced many useful reports that were widely distributed to other

faculty. The project greatly helped to place our department and university in a leadership position in digital computation.

Brice Carnahan's first contact with the Ford Foundation project occurred in the summer of 1959, when Don Katz offered him a full-time job with his project. Brice's acceptance put his doctoral thesis "on hold" and delayed his Ph.D. by "an unconscionable number of years," but he never regretted the decision because of the opportunities that it provided him.



Elliott Organick and James Wilkes, University of Houston, July 1963.

The principal recommendations of the Ford project, which are still largely on the mark 40 years later, were to:

1. Train faculty to use computers.
2. Provide "free" time-shared computing services to all students.
3. Require a computer-programming course.
4. Teach numerical and optimization methods.
5. Integrate computing assignments into all engineering, science, and design courses.
6. Stress design-like (now called "open-ended") problems throughout the curriculum.



Elliott I. Organick

Don Katz was the director of the project throughout its duration, from 1959–1963; the three assistant directors were Elliott I. Organick (1959–1960), Sylvio Navarro (1960–1961), and Brice Carnahan (1961–1963). Elliott Organick had previously been a doctoral student in our department, working with Prof. Katz. He published his Ph.D. dissertation, *Hydrocarbon Vapor-Liquid Equilibrium*, in 1950. Elliott went on to positions of distinction at the University of Houston and the University of Utah; Sylvio Navarro very sadly died in an airplane crash soon after leaving the project. The Ford Foundation Project and Don Katz gave us the start to what has now become the standard in the engineering profession: to use computers to provide us with solutions to difficult problems. We have evolved from punching cards and programming in FORTRAN and MAD (Michigan Algorithm Decoder) and a room full of computer equipment with communications by submitting punch cards through a window, to a PC on nearly every desk and in nearly every home to solve the most complex problems. Those who participated in this pioneer project will always remember it as a fun and challenging time.



LGP-30 computer, used by the Ford Foundation Project.

The Carnahan evening computing lectures. As an outgrowth of the Ford Foundation project, Brice Carnahan presented a famous and highly popular series of six two-hour evening lectures in the U–M Natural Science Auditorium on

computers and programming, first in “MAD” and later in FORTRAN; one memorable lecture was given in a Batman costume to compensate for a time conflict with the premier hour of the Batman television series. These evolving lectures were attended each term by about 300 students, faculty, staff, and lay persons who needed a quick, non-credit introduction to computers and programming; the series began in 1960 and lasted for 25 years, until fall 1984, well into the PC era. Jim Wilkes also presented several of these lectures in the final years of the series.

Computers in engineering design education. A pilot project to study the use of computers and optimization techniques in engineering design education was organized in the fall of 1964 and based in the chemical engineering department at the U–M, under the auspices of the Commission on Engineering Education. This project, supported by the National Science Foundation and modeled after the earlier Ford Foundation project, had three major objectives:

1. The training of engineering design teachers in subjects related to computer-aided design.
2. The study of the role of the computer in engineering design education.
3. The generation of a substantial number of completely documented computer-oriented design problems.

Throughout the project, “Computers in Engineering Design Education,” Don Katz was the director and Brice Carnahan was the associate director, from 1964–1966. Warren D. Seider, then a doctoral student in our department was a graduate assistant, and his involvement with the project led directly to his appointment as a faculty member with expertise in computer-aided design at the University of Pennsylvania.

In the fall of 1964, engineering design teachers with a substantial amount of computing experience were invited to apply for an intensive nine-week program to be held at the U–M during the summer of 1965. An advisory committee of the Commission on Engineering Education assisted in selecting from among the applicants 29 engineering design teachers from 23 different engineering schools.

Five weeks of the summer program were devoted to formal presentations of computation, numerical mathematics, modeling and simulation, mathematical optimization techniques, problem-oriented languages, man/machine interaction, economics, and industrial design practice. During the remaining four weeks, each participating professor solved and documented one or more individual design problems appropriate for inclusion in an engineering design course in his own field. The primary disciplines represented were chemical, civil, electrical, industrial, and mechanical engineering.

During the fall of 1965, the project staff and one summer-program participant from each of the primary disciplines edited or revised solutions to the participants’ design problems and prepared material for the final project report, which was published in six volumes. The recommendations covered:



Prof. H.A. Luther at Texas A&M University, June 1964.

1. Development of introductory computing courses.
2. Incorporation of computing work into upper-level courses.
3. The need for numerical and statistical mathematics, mathematical modeling, optimization techniques, special-purpose computing languages, and the manipulation of graphical information.
4. The commonality of engineering design techniques across various engineering disciplines.
5. The need for special-purpose problem-oriented languages (e.g., chemical process simulators).
6. The need for rapid interaction between designer and computer, especially when tackling open-ended problems.
7. The need for time-sharing computers in conjunction with graphical displays.
8. The fact that designer/computer interaction now allows the student to gain useful “engineering experience” before he or she enters a true industrial environment.
9. The need for a larger proportion of university budgets to be allocated to the rapidly expanding field of digital computing.
10. The significant effort needed to train teachers in engineering design techniques.

Applied Numerical Methods

Nationally, Brice Carnahan and Jim Wilkes are probably best known for their coauthorship of *Applied Numerical Methods*. The venture was conceived in typical style by Don Katz, who suggested near the end of the Ford Foundation Project that Brice and Jim write up “a few notes” on numerical methods for computers. They were joined by mathematician Prof. H.A. Luther from Texas A&M University.

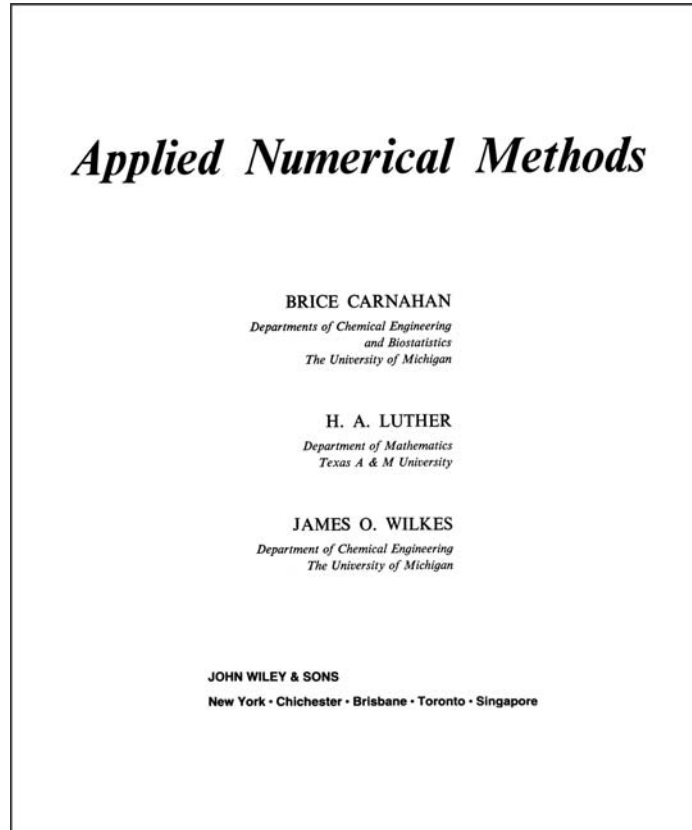

Title page of “Applied Numerical Methods” (reformatted).

After 18 months of very hard work, a paper-back preliminary edition of “ANM” was published locally in 1964; it contained eight chapters, 790 large (8½ by 11) pages, and 47 completely documented computer programs illustrating the various techniques. It also included a significant appendix on the “MAD” (Michigan Algorithm Decoder) language (an ALGOL 60 derivative), which was used for the computer programs. A hard-cover edition of just over 600 pages (again in a large format), illustrated with 40 FORTRAN programs, was finally published by John Wiley & Sons, Inc., in 1969, and was very popular nationally for the following 20 years.

A related graduate course on numerical methods for solving engineering problems, ChE 508, has been taught by Brice and/or Jim every year from 1967–2001. It has proved quite popular, and has attracted students from outside chemical engineering. Because of strong opposition from some faculty in the U–M mathematics department (somebody said it was “a cancer in our midst”)—probably because they thought we were infringing on their turf!—the introduction of ChE 508 was actually voted down at an engineering faculty meeting in about 1967, so we taught it that year in disguise as a “special topics” course. At the next faculty meeting, there was no opposition. Less frequently, a second course, ChE 608, has been offered for instruction in more advanced numerical topics.



James Wilkes

Chemical engineering senior Heidi Bautista with (left-to-right) telephone and acoustic coupler, hard drive and Amdek color monitor, IBM PC and green monochrome monitor, and Epson printer. April 1983, 3146 H.H. Dow Building.

CAEN—The Computer-Aided Engineering Network

A new vision for computing in our College of Engineering came first in 1983, when our dean, James J. Duderstadt, brought together a group of faculty (including Brice Carnahan) to plan the “complete integration” of computing into the life of the college. The group concluded that:

“The personal computer/workstation, connected to the rest of the world via a hierarchical, heterogeneous, multi-vendor network, will be central to the engineering computing paradigm well before the turn of the century.”

The group decided that a networked personal-computer/workstation infrastructure was the first prerequisite for effective implementation of the broad goal of “computing in the curriculum.” In 1984, the college began to implement the plan by:

- Starting to build a college network connected to, but otherwise independent of the university’s central mainframe computing facilities.
- Creating a college network management structure that would foster personal, academic, and research use of the new facilities, including a full-time network staff and an executive committee representing the faculty. An “applications sector” concept for supporting general-purpose commercial productivity and discipline-oriented professional software (e.g., CAD, design, control) was also initiated.
- Putting a networked personal computer on the desk of every faculty member in the college. The dean sent out the word that electronic mail should be the principal means of communication for the faculty and staff (although—surreptitiously—some of us did still talk to one another!)
- Establishing a long-range financial plan. The college made a firm commitment to maintain state-of-the-art facilities, replacing outdated equipment and software with the current “best” affordable. The plan did call for a surcharge on student tuition, but we believe that it was a better option than the strategy at many other universities—that of requiring each student to purchase a computer at the beginning of his/her college education and hoping somehow that it would suffice for the next four years.

Professor Bartels’ successor as director of the Computing Center was invited to join the project, but still clung to the concept of one central facility; thus, the College of Engineering spearheaded the networked concept and for several years enjoyed high-quality distributed facilities unavailable to the rest of the U–M.

Since its inception in 1984, the college network grew substantially, and by 1990 it included the following:

1. A 100 mbps FDDI (fiber distributed-data interface) optical-fiber token-ring backbone.
2. Two IBM token-ring LANs (local-area networks) interfaced to the backbone.
3. Over 30 Ethernets (at least one in each engineering building) interfaced to the backbone.
4. Three bridged Apollo workstation 15 mbps optical-fiber token rings, gatewayed through Ethernets to the FDDI backbone.
5. Subsidiary LANs (e.g., office Apple Talk networks gatewayed to building Ethernets).
6. About 2,000 attached machines distributed as follows:
 - 650 in 18 open (24 hours/day) computing clusters, principally for undergraduates.

- 700 in departmental teaching and research laboratories, principally for graduate student and faculty research.
- 650 on faculty and professional staff desks, and for college and departmental administrative and clerical staffs.

The public workstations in 1990 included a mix of IBM PS/2 (386DX and 386SX) and Macintosh II computers, and workstations by Apollo, DEC, Sun, Hewlett Packard, and IBM (RS6000).

Freshman Computing Instruction

For various extended periods since 1967—and continuously over the 15-year period 1981–1996—Brice Carnahan and Jim Wilkes were responsible for organizing and supervising all freshman engineering digital-computing courses at the U-M and maintaining the freshman engineering computing (FEC) laboratories. The main-frame computer at the Computing Center was used exclusively in these courses until 1982 (the year in which punched cards were abandoned!), when two IBM PC laboratories were installed in East Engineering.

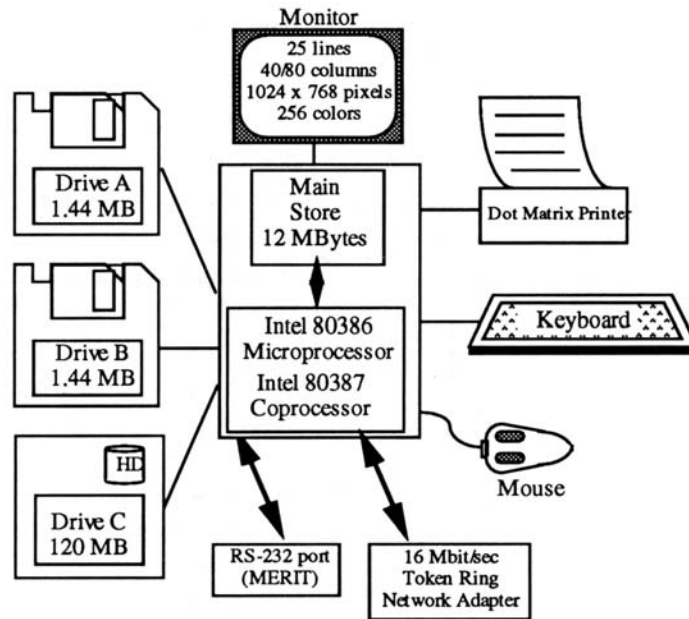

Configuration of the IBM PS/2s in the FEC and CAEN laboratories.

As of mid-1984, there were 50 IBM/PC computers in the FEC laboratories, configured in a local-area network manufactured by the 3com Corporation using

the *Ethernet* communication protocols. Four PC/XT computers, each with a 10-megabyte hard disk, functioned as network servers. Each of the IBM/PCs could also communicate via secondary communications processors (modified DEC LSI-11 microcomputers) and the state-funded MERIT packet-switching network to the U-M's large Amdahl 5860 mainframe computer at the Computing Center. Each of the IBM/PC computers was equipped with:

1. An Intel 8088 microprocessor and 256K bytes of main memory.
2. A keyboard, and an Epson dot-matrix printer with Graftrax, enabling the printer to generate graphical images.
3. A Zenith green-screen monitor with a color graphics board, thus allowing graphical images to be displayed on the monitor screen.
4. Two single-sided floppy disk drives with 180K bytes per diskette.
5. An RS-232 port to the MERIT network.
6. A 3com Ethernet connection board.
7. A battery-powered time-of-day clock.
8. A game board that allowed future use of a mouse or other pointing device.

When the basement of the Herbert H. Dow building was finished in 1985, these computers were moved at that time to North Campus, occupying two classroom/laboratories (1210 and 1214 Dow) and one open-computing laboratory (1218 Dow). New IBM PS/2 computers were acquired in 1989. A further move occurred in 1992 to the basement of the North Campus Commons (later renamed the Pierpont Commons), where the facilities that we designed included two 38-station classroom/laboratories (B505 and B507 NCC), an open-computing laboratory (B521 NCC), an office for the student instructors, an office for the laboratory assistants, and a storage room.

By 1992, there were 70 IBM PS/2 computers in the FEC laboratories, and their configuration is shown in Table 25†.

Each PS/2 was attached to a 16-Mbps IBM token ring local-area network (LAN) through a token-ring adapter. Two IBM PS/2 Model 80 computers with hard-disk storage capacities of 314 Mbytes each were also attached to the token ring and functioned as network servers. Additional connectors also allowed access to computing resources outside the FEC laboratories.

The enterprise had constantly grown in magnitude and complexity, to the point where it occupied about half of Brice and Jim's professional time for the decade 1986–1996. During this period these courses were taught, very successfully, by an all-student cadre of instructors, many of whom were either U-M *undergraduates* or had moved on to graduate work at the U-M. Thus, most of the instructors were

† Page 1–39 of Brice Carnahan and James O. Wilkes, *The IBM PS/2 and the Macintosh—Operating Systems and Applications*, with contributions from David Nagle, Thomas Williams, Vinay Reddy, and Chris Goralski, published by the authors, Ann Arbor, 1992.

Table 25 Configuration of the FEC IBM PS/2 Computers

<i>Component</i>	<i>Capacity/Performance</i>
Model	IBM PS/2 Model 70
Microprocessor	Intel 80386DX
Coprocessor	Intel 80387
Microprocessor clock rate	20 MHz
Microprocessor wait states	0–2
Microprocessor data path	32 bits
Microprocessor operand length	32 bits
Microprocessor instruction rate	2 Mips (approx.)
Floating-point instruction rate	0.3 Mflops (approx.)
RAM (main memory)	12 Mbytes
RAM access time	85 nanosec
Hard-disk storage units	One, drive C
Hard-disk storage capacity	120 Mbytes
Hard-disk access time	23 millisecc (average)
Hard-disk data-transfer rate	1.28 Mbytes/sec
Diskette drives	Two, drives A and B
Diskette type	3.5-inch high density (MFD–2HD)
Diskette storage capacity	1.44 MBytes
Monitor	IBM Model 8514
Monitor adapter	IBM Model 8514A
Monitor resolution	1024 × 768 pixels
Monitor text-mode character box	12 × 20 pixels
Monitor text-mode characters	25 or 43 lines, 40 or 80 columns
Monitor palette	262,144 colors
Monitor colors in single image	256 maximum
Keyboard	IBM PS/2 standard model
Mouse	Two-button
Serial ports	One, RS–232
Serial port transmission rate	19,200 baud
Expansion slots	One 16-bit, two 32-bit
Network adapter	IBM 16 Mbits/sec Token Ring
Local printer (may be removed)	Epson or IBM Proprinter dot-matrix
Local printer format	6 or 8 lines/inch, 80 or 132 columns
Network printer	Hewlett Packard Laserjet 3si
LaserWriter resolution	300 dots/inch
LaserWriter printing rate	8 pages/minute, double-sided

very sympathetic to the problems and concerns of our college freshmen, and often acted as mentors to them.

The general excellence of these student instructors showed in their teaching evaluations, which were significantly higher on average than those for the engineering faculty. At any time during this period, Brice and Jim typically worked with approximately 15 student instructors and 30 laboratory assistants; management of the computers was very ably supervised by Jim Rennell, who had graduated with his B.S.E. from the EECS department at the U–M, and eventually worked at CAEN.

The following 21 photographs depict several of the prominent student instructors and administrative personnel from 1987–1996.

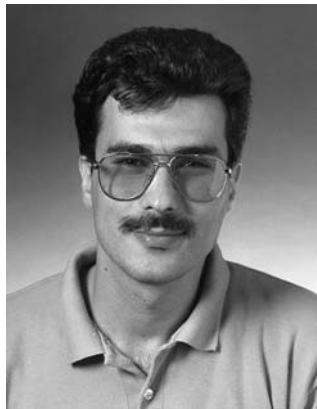

Nabil Abdel-Jabbar (ChE)



Melissa Babcock (ChE)



Brice Carnahan (ChE)



Bill Cosnowski (I&OE)



Glen Forbis (ME&AM)



Chris Goralski (ChE)



Matt Houser (Comp Engr)



Brian Kirby (Aero)



Debbie Lenz (NAME)



Robert Lepler (NAME)



David Nagle (EECS)



Scot Osburn (Aero)



Mich Rasulis (EECS)



Vinay Reddy (Bio Engr)



Jim Rennell (CAEN)



Julie Scherer (EECS)



Bennett Stone



Tim Westman (EECS)



Jim Wilkes (ChE)

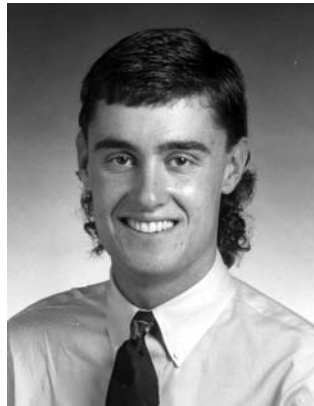

Tom Williams (ME&AM)



Annie Wu (EECS)

Typically, about 1,100 students enrolled each year (including the spring half term in May/June) in about 30 sections of four different courses, with a maximum enrollment of 38 students per section. The courses were chosen to respond to the needs of the various departments. Three of them were four-credit hour courses: Engr. 103 (FORTRAN based), Engr. 104 (C based), and Engr. 106 (including Matlab and C); the fourth course was Engr. 105, which offered a one-credit introduction to the Michigan computing scene for transfer students.

After substantial and continuing consultation with college faculty, the following topics were included in Engr. 103, 104, and 106:

- General computer “literacy.”
- Hardware and network facilities to be used throughout the students’ academic careers.

- Basic productivity software to be used later in the students' academic careers, regardless of their discipline: word processing, drawing, drafting, plotting, spreadsheeting, symbolic mathematics, and data-base manipulation.
- Programming in a procedure-oriented language.
- Solution of problems designed to expose students to topics from different engineering disciplines.
- Participation in a group activity, typically cooperative design and implementation of a problem solution on the computer.



Group of freshman engineering computing instructors at the home of Jim and Mary Ann Wilkes, 12 April 1993. Back row (left to right): Nabil Abdel-Jabbar, Matt Houser, Jim Wilkes, Brian Kirby, Melissa Babcock, Jim Rennell. Front row: Bill Cosnowski, "Fuss," Scott Arens, Debbie Lenz, Scott Carr, Scot Osburn, Neil Chintamaneni, Glen Forbis, Rob Lepler.

Over the years, Brice and Jim have directly impacted perhaps 30,000 U–M freshmen through these courses. Very frequently—sometimes annually—they updated their two books for use in these freshman courses, the last titles being *FORTTRAN for the Macintosh and IBM PS/2* (1994) and *The Macintosh, the PC, and UNIX Workstations: Operating Systems and Applications* (1996). In all, there have been 27 different editions of these two texts or their predecessors, some of which are shown in an accompanying photo. With retirements not too far away, and considering the recommendations of *Curriculum 2000* (see below), Brice and

Jim relinquished supervision of the freshman-computing organization in 1996, after many challenging but happy years.

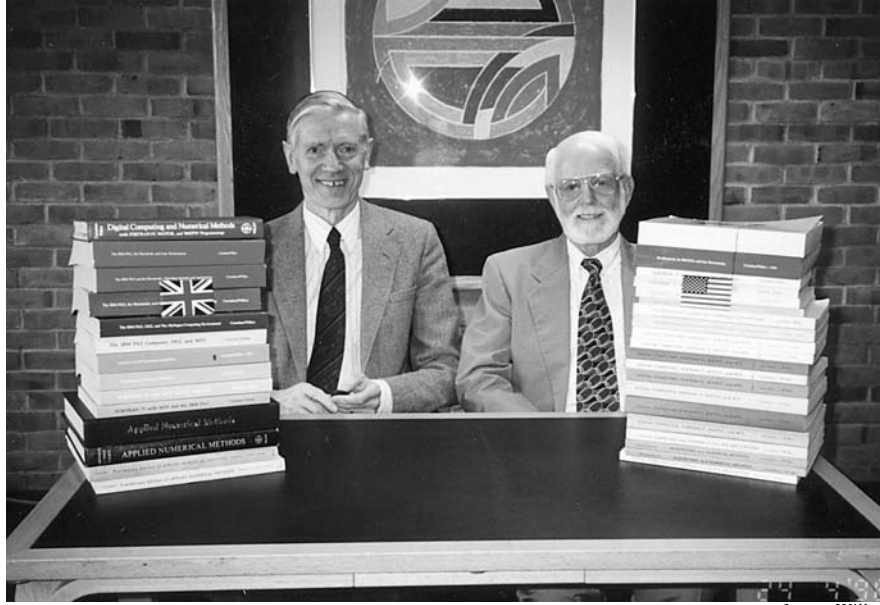

James Wilkes

Brice Carnahan and Jim Wilkes with the many books they have co-authored. Taken on 24 April 1996—just before the renovation of the Walter J. Podbielniak Room. See the Chapter 4 article on WJP for information on the Frank Stella lithograph in the background.

In 1995, Associate Dean Michael Parsons charged a college-wide committee to reexamine the entire undergraduate curriculum structure in the college. The committee's recommendations were embodied in their report, *Curriculum 2000*. Largely at the urging of some faculty in the EECS (Electrical Engineering and Computer Science) department, a single four-hour freshman computing course (Engr. 101) was introduced, in which productivity software was abandoned and computer structure and organization were introduced. From 1996 onwards, lectures were given by faculty to very large classes, and computer workshops were staffed by graduate-student teaching assistants. However, Engr. 101 was not "pure" enough in the direction of computer architecture for EECS, and their department seceded from the plan that they had initially supported, and introduced their own introductory course—a bizarre state of affairs that EECS finally reversed in 2000! Thus, with Engr. 101, the close student/instructor contact that had prevailed in the preceding ten years through the relatively small lecture sections largely disappeared, the students had to learn the productivity software on their own, and flexibility was lost when the spring half-term offerings were discontinued. Such can happen when the curriculum is entrusted to a committee!

Department Computing, 1995–2002



Michael Africa

In the mid-1980s, we hired our first computer systems administrator, who was responsible for supporting all the desktop computers in the department. By the early to mid-90s, desktop computers (“PCs”) had replaced typewriters and word processors as the main tool of an efficient office. Today, PCs are essential not only to teaching and research, but also to the staff and administrators supporting the department. A U–M 1994 chemical engineering graduate, current Computer Systems Administrator Michael Africa originally joined the department as a temporary staff member authoring multimedia programs for Prof. Susan Montgomery. In 1995 he received a permanent appointment as the department’s computer systems administrator. Michael’s fascination with computer technology be-

gan in 1988 with the arrival of the first operating system to popularize the graphical user interface: the Macintosh operating system (successor to the Lisa, also developed by Apple Computer).

In his current position, Michael Africa has found a workable balance between his interest in chemical engineering and the challenge of computer-system administration. Michael provides broad support for the department’s computers and network, including everything from writing databases to installing and troubleshooting machines, to training staff on new software applications. Despite his own preference for the Mac, Michael says that each platform has its strengths and weaknesses, and in fact at home he owns both an Apple (running Mac OS†) and a Dell (running Windows). Machines today share the same hardware, such as hard drives, RAM, fans, etc.—the BIOS and ROM being the main differences. The worldwide trend toward smaller, faster computers has been reflected in the working styles of chemical engineering faculty, staff, and students. In the past 3–4 years, for instance, laptop computers have become so compact, durable, and reliable that 75 percent of faculty regularly use one in their teaching and research. Inexpensive desktop machines and faster connections for home use, including cable modems and DSL, enable faculty and staff to work from almost any location.

Today’s ChE network consists of approximately 270 computers, 70 percent of which are in the laboratories. About 80 percent of the machines run the Macintosh OS; the rest run some version of Microsoft Windows (mostly used for data

† Acronyms used here: OS = operating system, RAM = random-access memory, BIOS = basic input/output system, ROM = read-only memory, DSL = digital subscriber line, BSD = Berkeley software distribution, ATM = asynchronous-transfer mode, TFT = thin-film transfer.

handling) or Unix. All staff, and all but one faculty member, use Macintosh computers as their primary desktop machines. One of the most significant changes in terms of operating systems was the fall 2001 implementation of Mac OS X, which is based on the powerful open-source BSD Unix. Also in the fall of 2001, CAEN began responding to heavy (and slow!) network traffic by re-wiring the engineering buildings for data transmission. The H.H. Dow Building was among the first to benefit from these much-needed upgrades. The department's computers are connected via peer-to-peer filesharing (as opposed to the client-server model) over a 100 MB Ethernet backbone. Wiring is mainly copper, except where fiber optic cables are used to link the ChE section of the network to the ATM cloud, which has a much higher bandwidth.

Despite the proliferation of technology, some 40 network printers keep the department in paper up to its knees. In addition, the department has one color laser printer and numerous inkjet printers, which are now inexpensive and of sufficiently high quality for everyday use. Popular applications include all the latest business software: Microsoft Office (Word, Excel, and PowerPoint), and Filemaker and 4th Dimension for database applications. The department also heavily uses some non-business applications, especially Matlab, Mathematica, and Maple. Although most monitors are CRTs (with varying resolutions, depending upon the computer's video card), flat TFT displays are becoming more popular and affordable (and in fact, Apple no longer makes CRTs!). Peripheral devices such as 100-megabyte "Zip" drives, external hard drives, and Superdisk drives are so portable and inexpensive that the university does not even insure them against theft or loss. Michael expects the trend toward smaller, faster, less expensive computers to continue, and the department's reliance on technology to increase continually. The most obvious changes he sees coming are improvements in voice-recognition technology, wearable computers, and videoconferencing technology.

Computer-Based Research

The topic of computer-based *instruction* within the chemical engineering department is covered in Chapter 11 in the article "Educational Innovations."

Over the past 45 years, the general thrust of computer-based *research* has been the simulation of physical events, primarily to extend experimental work and to make predictions in cases in which experiments would be excessively costly or would extend over unacceptably long time frames. There have been two primary themes:

1. The solution of the partial differential equations that govern fluid mechanics and heat transfer, with a wide variety of applications to situations such as polymer processing and reservoir waterflooding.
2. Dynamical simulation and control of chemical plants, typically involving the solution of a large system of simultaneous ordinary differential equations.

Our progress in computer-based research is best summarized in Table 26, which gives as complete a list as possible of doctoral dissertations that involved very significant amounts of digital computation. The initials that follow the title indicate the faculty member(s) directing the work.† A dagger (†) indicates that significant laboratory work complemented the computer studies.

Table 26 *Computer-Oriented Doctoral Dissertations*

<i>Student, Date, Title, Supervisor(s)</i>	<i>Important Computing Features</i>
R.O. Gumprecht, 1953, <i>Determination of particle sizes in smokes.</i> (CMS)†	Used the ENIAC at Aberdeen Proving Ground for three volumes of mathematical tables on light scattering functions, Riccati-Bessel functions, and partial derivatives of Legendre polynomials.
William R. Martini, 1956, <i>Natural convection inside a horizontal cylinder.</i> (SWC)†	Pioneering numerical work, limited to 80 internal grid points, using an IBM 650 computer, with linearization of equations needed.
Arthur E. Ravicz, 1959, <i>Non-ideal stage multicomponent absorber calculations by automatic digital computer.</i> (JTB)	Used General Motors IBM 704 to examine heat and mass transfer from data and predict Murphree tray efficiencies for <i>individual components</i> .
Jesse D. Hellums, 1960, <i>Finite difference computation of natural convection heat transfer.</i> (SWC)	Investigation of transient natural convection at a vertical wall and inside a horizontal cylinder. FORTRAN with an IBM 704 computer.
James O. Wilkes, 1963. <i>Finite-difference computation of natural convection in an enclosed rectangular cavity.</i> (SWC)	MAD program, IBM 7090. Implicit alternating direction method & successive overrelaxation, fully 2-D vorticity/stream function formulation.
Clifton S. Goddin, Jr., 1965. <i>Two-dimensional flow of two immiscible incompressible fluids in a stratified porous medium.</i> (MRT, JOW)†	Capillary-pressure and gravitational induced crossflow between different rock strata during water-flooding of partly depleted reservoirs.

† MAB, Mark A. Burns; JTB, Julius T. Banchero; DEB, Dale E. Briggs; BC, Brice Carnahan; SWC, Stuart W. Churchill; JDG, Joe D. Goddard; RHK, Robert H. Kadlec; CK, Costas Kravaris; RGL, Ronald G. Larson; TCP, Tasos C. Papanastasiou; RDP, Robert D. Pehlke; PES, Phillip E. Savage; CMS, Cedomir M. Slipevich; MRT, M. Rasin Tek; JOW, James O. Wilkes; and RZ, Robert Ziff.

D. Grant Fisher, 1965. *Frequency response of flow forced heat exchangers.* (RHK)†

Warren D. Seider, 1966 *Confined jet mixing in the entrance region of a tubular reactor.* (SWC)†

Andrew S. Teller, 1966. *Heat transfer in solidifying bars.* (JOW)†

Li-Chiu Tien, 1967, *Freezing of a convective liquid in a crystal growth tube.* (JOW)†

Thomas G. Smith, 1969. *An investigation of free-surface flow into a vertical cylindrical enclosure.* (JOW)†

Lilan L-Y. Chan, 1972. *Experimental observations and numerical simulation of the Weissenberg climbing effect.* (JOW, JDG)†

Thomas L. Gould, 1972. *Vertical two-phase flow in oil and gas wells.* (MRT)†

Peter E. Parker, 1974. *A dynamic ecosystem simulator.* (RHK)†

Luis A. Lopez, 1974. *DYSCO: An interactive executive program for dynamic simulation and control of chemical processes.* (BC, DEB)

Dynamic modeling, computer simulation, and frequency-response analysis were confirmed by experiments on pilot-plant heat exchangers.

MAD program, IBM 7090. Implicit alternating direction method to solve momentum equations; mass transfer by Crank-Nicolson method.

Zone refining of indium antimonide. MAD program on IBM 7090 included heat and momentum transport with phase change at curved interface.

Finite-difference solution included natural convection in the melt. Agreed with experiment for growth of single crystal of naphthalene.

Marker-and-cell and DuFort-Frankel methods gave accurate predictions of velocities and free-surface profiles for injection of Newtonian polymers.

FORTTRAN program on IBM 360/67 used the Rivlin-Ericksen fluid model to predict velocities and interface shapes for a polyacrylamide solution.

FORTTRAN IV program on IBM 360/67 accounted for five possible flow regimes and used comprehensive routines for physical properties.

An extension of modular process simulation techniques to the analysis of data from a dynamically and spatially varying ecosystem..

Probably the first interactive general purpose dynamic chemical process simulator. Highly modular program. Used commercially.

- Surendra P. Singh, 1976. *AGPSS: A graphical process simulation system*. (BC)
- Antonio Valle, 1979. *The finite-element method and the Stefan problem*. (RDP, JOW)
- David E. Hammer, 1984. *An engineering model of wetland/wastewater interactions*. (RHK)†
- John C. Fagley, Jr., 1984. *Flexibility and efficiency in modular dynamic chemical plant simulation*. (BC)
- Michael J. Beffel, 1986. *Finite-element investigations into the general energy equation*. (JOW)
- David B. Bartus, 1987. *Parameter estimation in dynamic systems*. (BC)
- Rosemarie D. Wesson Williams, 1988. *Computer-aided analysis of viscoelastic flows*. (TCP, JOW)
- Jolly S. Ahluwalia, 1988. *Wellbore storage effects in the transient flow-testing of gas wells*. (JOW)
- Edsel D. McGrady, 1988, *Coagulation and breakup of droplets in turbulent Couette flow: theory, simulation, experiment*. (RZ)†
- The first nonproprietary interactive graphical interface for a process simulator. Output used as input for the process simulator PACER
- 2,752 FORTRAN statements employed the finite-element method and satisfactorily confirmed the experimental results of Tien (1967).
- Finite-difference dynamic simulation of water and nutrient flows and their interaction with plant growth in wetlands.
- The program structure allowed for modular integration of large, stiff plant models involving thousands of ordinary differential equations.
- FORTRAN 77 program on Apollo DN660 computer employed 2- and 3-D finite-element simulations of solidification in various metal castings.
- Parameter estimation in models of dynamic systems characterized by sets of non-linear and stiff ordinary differential equations.
- Solved 2-D die-swell problem at high Weissenberg numbers, using FORTRAN with remote access to CRAY X-MP supercomputer in San Diego.
- Method of characteristics to investigate sonic transients, unloading and storage effects, and pseudo steady-state. Agreement with field data.
- Pascal program on an Apollo DN 460 computer for the Monte-Carlo simulation of droplet breakup and coalescence.

- Kristen Fichthorn, 1989, *Monte-Carlo methods in surface science and catalysis*. (RZ)
- Nitin R. Anturkar, 1990. *Mechanics and stability of multilayer extrusion*. (JOW)
- Richard Dennis Vigil, 1990, *Kinetics of aggregation-fragmentation processes*. (RZ)
- Nikolaos Malamataris, 1991. *Computer aided analysis of flows on moving and unbounded domains: phase change fronts and liquid leveling*. (TCP)
- Kevin R.J. Ellwood, 1991. *The mechanics and stability of liquid jets and films*. (JOW)
- Seyed M. Alaie, 1992, *Manufacturing of polymer films and fibers: fluid mechanics, rheology, and computer-aided analysis*. (TCP)
- Elizabeth C. Hainey, 1993, *Temperature and pressure distributions of natural gas in aquifer storage reservoirs*. (JOW)
- Joseph P. Greene, 1993. *Fiber orientation during injection molding of glass-fiber-reinforced thermoplastics: an experimental and numerical investigation*. (JOW)[†]
- Benjamin Brosilow, 1993, *Monte Carlo simulation of surface reactions (transition metals)*. (RZ)
- Monte-Carlo simulations on 1024×1024 lattices required about two years of CPU time on the Apollo DN660 computer network.
- FORTRAN 77 program employed Oldroyd B model and Carreau viscosity function to delineate stable modes of operation of multilayer extruders.
- Pascal program for simulating particle clustering and breakup, with an Apollo Domain 4000 computer.
- Employed free boundary condition and inverse finite-element method to study continuous casting, composite processing, and liquid leveling, etc.
- Used the finite-element method to study the instability of 2- and 3-D jets, also electrohydrodynamic jets, and leveling of Oldroyd-B coatings.
- Used the finite-element method and the Papanastasiou/Scriven/Macosko model to investigate film casting, fiber-spinning, and film blowing.
- Some 6,000 lines of FORTRAN 77 using finite-element method to study Joule-Thomson cooling and hydrate formation over many yearly cycles.
- Modified FLOW-3D marker-and-cell method to predict free-surface locations and fiber orientations for injection molding of a rectangular plate.
- C language program for Monte-Carlo simulation of carbon monoxide oxidation on catalysts.

Nabil M. Abdel-Jabbar, 1996. *Parallel simulation and state estimation algorithms for dynamic systems on multicomputers*. (BC, CK)

Tahmid I. Mizan, 1996, *A Molecular investigation of supercritical water and solvation of the hydroperoxyl radical therein*. (PES, RZ)

Richard H.J. Blunk, 1996. *Surface-tension-driven flows of coatings: bondline readout formation*. (JOW)[†]

Naoko Akiya, 2001, *Molecular-level insights into chemical reactions in high-temperature water*. (PES)

Lei Li, 2001, *Molecular dynamics of dilute polymer solutions with applications*. (RGL)[†]

Cattaleeya Pattamaprom, 2001, *Quantification of polymer melt dynamics*. (RGL)[†]

Manish Chopra, 2001, *Dilute-solution DNA micro-hydrodynamics*. (MAB and RGL)[†]

Christian D. Lorenz, 2002, *Percolation theory and its applications to chemical engineering problems*. (RZ)

Michael Zaldivar, 2002, *Lattice based Monte Carlo simulations of polymer-surfactant systems*. (RGL)

General dynamic simulator framework and software for parallel modular integration. Involved large scale stiff process-equation system.

Molecular dynamics simulations provided molecular-level insights into supercritical water and its use as a reaction medium.

Comprehensive study of leveling of paint films, involving mass, heat, and momentum transport, coupled with the motion of a free surface.

The role of water in specific chemical reactions was elucidated by computational quantum chemistry and by molecular dynamics simulations.

Brownian dynamics simulations of bead-spring model enable the properties of polymer solutions to be predicted quantitatively.

Molecular modeling of the rheological properties of polymer melts. Finite-difference solutions of partial differential equations.

Use of Brownian dynamics simulations to understand the behavior of DNA molecules close to a surface and in the presence of flow.

Computer-based Monte-Carlo simulations for precise predictions relevant to percolation theory.

Complexes investigated include micellization nucleated on polymers, important in photographic emulsions, cosmetics, and shampoos.

Chapter 13

SOME RESEARCH ACTIVITIES

Introduction

Extensive summaries of research from 1971 to 2002 are given in Chapters 9 and 10, and research projects supervised by Prof. Stuart Churchill in the 1950s and 1960s are detailed in Chapter 8. Here—as a supplement—we present articles on half-a-dozen different research areas.

EARLY HEAT-TRANSFER RESEARCH

by Al Mueller, Ph.D. 1937[†]

THE use of doctoral dissertations as a measure of heat-transfer research activity shows three dissertations in the late 1920s, fourteen during the 1930s, eight in the 1940s, and eleven in the 1950s (the limit of my data source). External events had influences on heat-transfer research. For instance, the Depression began in the late 1920s and extended well into the 1930s; thus, nearly all of those fourteen dissertations were produced in the last half of that decade. The publication in 1933 of McAdams *Heat Transmission* was an excellent status report on the state of heat-transfer knowledge. The surge of heat-transfer papers from Michigan and other institutions inspired ASME to seek help from AIChE in the late 1930s to form a Heat-Transfer Division. The apparent drop in research in the 1940s may not be real as the government during and after World War II sponsored much heat-transfer research on aircraft engines, jet engines, rockets, and atomic energy projects, much of which was classified. By the 1950s there was sufficient heat-transfer research world-wide to hold an international conference in 1951. In the mid 1950s ASME and AIChE jointly sponsored the National Heat Transfer Conferences and AIChE formed its Heat Transfer and Energy Conversion Division.

In the 1930s the Chemical Engineering Department was located in the East Engineering Building and had a general laboratory that extended from the basement to the third floor. In this space there were installed several pilot-plant-sized

[†] Alfred C. Mueller obtained his Michigan doctorate working with A.H. White. His dissertation was entitled *Temperature Variation around the Perimeter of a Tube on Condensing Pure and Mixed Vapors*.

evaporators (horizontal-tube natural circulation, vertical-tube natural and forced circulation), a distillation column with the necessary auxiliary equipment of tanks, pumps, condensers, and heaters, etc. These were used for undergraduate unit operations laboratory experiments and for some research projects. Many of the heat-transfer research projects were located in this laboratory. Since the steam and water supplies to the research apparatus were controlled by hand-operated valves, fluctuating pressures in the supply headers could not be tolerated; thus, much of the research was done at odd hours of the day and during weekends or vacation periods. There was some, but not much, professional help available for fabrication of equipment, but assembly and piping were the researcher's responsibility. The result was an occasional complex arrangement and in the mid 1930s an informal cup (the "Badger trophy") was awarded "honoring" the researcher with the weirdest arrangement. Instrumentation was basic: orifices, manometers, potentiometers, scales, and stopwatches; we had no controllers, recorders, transmitters, or computers.

At least one undergraduate class in the unit operations laboratory did some research. The rate of salting-out in an evaporator was investigated in a 48-hour run scheduled for a weekend. The class was divided into three shifts and each person was assigned a specific job and rotated between these jobs every two hours. Professor Badger was available around the clock, occasionally napping on a cot in his office.

Nearly all of the heat-transfer research in the 1920s and 1930s was done under the direction of Professor W.L. Badger and was related to the problems of evaporator design and operation. In the late 1920s there were three major projects:

1. Overall heat-transfer coefficients were measured for boiling water in several different types of evaporators.
2. The effect of small amounts ($< 5\%$) of air on the condensing coefficients of steam. This is a problem in the later stages of a multistage evaporator system.
3. A laboratory study of calcium sulfate scale formation, which is a constant problem in evaporators.

In the late 1930s techniques had been developed for measuring tube-wall temperatures, and most of the research in that period involved the measurement of film coefficients. Dowtherm, a mixture of diphenyl and diphenyl oxide, was developed as a high-temperature heat-transfer fluid and in 1930 Carl Monrad reported on the condensation coefficients for diphenyl and in 1935 Donald Ullock reported on the film coefficients for condensing Dowtherm to heating petroleum and linseed oils.

The forced-circulation evaporator, FCE, and the long-tube vertical evaporator, LTVE, were the subjects of many dissertations. Both evaporators had traveling pressure and temperature probes, which allowed determination of the preheating and boiling zones. The FCE was tested with a number of liquids to determine the

effect of physical properties. Entrainment from the FCE and the effect of air in the steam was also measured. The natural circulation velocities in a basket-type evaporator having 4-ft tubes were investigated. The overall and film coefficients of the LTVE were also measured. Other heat-transfer research included the condensation of mixtures having immiscible condensates, an absorption/refrigeration system using lithium salt solutions, scale formation of calcium sulfate and calcium carbonate mixes, and the start of a long research program on low-finned tubes with the Wolverine Tube Company. During the last half of the 1930s, Professor E.M. Baker and Professor D.L. Katz were also supervising some of the above research.

By present standards some of the above research would have been in trouble. Whenever the Dowtherm system was used it could be smelled throughout the laboratory and much of the building, and there was a small fire at a leak but no damage—only some soot. The loading and draining of chemicals in the equipment, the collection and measuring of samples and the application and removal of asbestos insulation as done then would not be tolerated today, but we did survive!

HEAT-TRANSFER DOCTORAL RESEARCH

by Edwin H. Young

AN overall picture of our heat-transfer research can be obtained from the following list of doctoral dissertations in the area, supplemented by some photographs. Excluded are investigations in which direct heat transfer is somewhat tangential to the main theme, such as in crystallization, thermodynamics, thermal cracking, and the determination of thermal properties. Where known, the initials of the faculty supervisor are included.†‡ The indicated year of publication may differ by one year from that printed in the dissertation because of the yearly groupings.

1920s

Lawrence A. Philipp, 1926, WLB. *The transfer of heat from metal to boiling liquids with forced convection.*

Donald F. Othmer, 1927, WLB. *The effect of temperature, purity and temperature drop on the rate of condensation of steam.*

† WLB = Walter L. Badger, EMB = Edwin M. Baker, REB = Richard E. Balzhiser, JTB = Julius T. Bancho, Barry = Robert E. Barry, JCB = John C. Brier, GGB = George Granger Brown, SWC = Stuart W. Churchill, ASF = Alan S. Foust, JHH = James H. Hand, EHH = Edward H. Huckle, DLK = Donald L. Katz, JJM = Joseph J. Martin, DRM = Donald R. Mason, RDP = Robert D. Pehlke, EJP = Elmore J. Pettyjohn, AHW = A.H. White, RRW = Robert R. White, JOW = James O. Wilkes, GBW = Brymer Williams, EHY = Edwin H. Young, JLY = J. Louis York.

‡ To avoid several pages of distracting upper-case first letters, titles of dissertations generally appear with only the first letter of the first word capitalized.

1930s

The 1930s clearly represented the heyday of Walter Badger's investigations into heat transfer in evaporators.

James V. Hunn, 1930, GGB. *Gaseous explosions, flame and pressure propagation.*

Carl C. Monrad, 1930, WLB. *The condensation of diphenyl vapor and the application of Nusselt's theory.*

Mott Souders, Jr., 1931, GGB. *Gaseous explosions. The effect of tetraethyl lead and hot surfaces on flame and pressure propagation.*



Courtesy Judson Brown

Walter L. Badger.

George M. Hebbard, 1934, WLB. *The rate of heat transfer through films of condensed steam on a vertical tube.*

Leonard A. Logan, 1934, WLB. *Liquid film coefficients in a vertical-tube forced-circulation evaporator.*

Charles R. Owens, 1934, WLB. *Water film coefficients in a forced-circulation evaporator.*

Stanley J. Meisenburg, 1935, WLB. *The influence of small concentrations of air in steam on the steam film coefficient of heat transfer.*

Donald S. Ullock, 1935, WLB. *Study of the liquid film heat-transfer coefficients between condensing Dowtherm-A vapors and petroleum and linseed oils in a vertical-tube heater.*

Jesse Coates, 1936, WLB. *The effect of viscosity on coefficients of heat transfer in forced-circulation evaporators.*

Nathan Fragen, 1936, WLB. *Heat-transfer coefficients in vertical-tube forced-*

circulation evaporators.

Robert M. Boarts, Jr., 1937, WLB. *Liquid film heat-transfer coefficients for long vertical tubes.*

Charles H. Brooks, 1937, WLB. *Overall heat-transfer coefficients in the boiling section of a long-tube natural-circulation evaporator.*

Alfred C. Mueller, 1937, AHW. *Temperature variation around the perimeter of a tube on condensing pure and mixed vapors.*

Alan S. Foust, 1938, WLB. *A study of liquid velocity in natural-circulation evaporators.*

George W. Stroebe, 1938, WLB. *Boiling film heat-transfer coefficients in a long-tube vertical evaporator.*

1940s

Here, with Beatty's work, we see the beginning of the finned-tube era, started by Alan Foust but expanded considerably by Donald Katz and (later) by Edwin Young.

Gerard W. Mulder, 1940, JCB. *The mechanism of heat transfer to boiling liquids in a vertical tube.*

Utah Tsao, 1940, EMB. *Heat-transfer coefficient of condensation of vapors of nonmiscible liquids on horizontal pipes.*

Harry E. O'Connell, 1942, EJP. *A study of entrainment in a horizontal-tube evaporator.*

Russell F. Hazelton, 1942, EMB. *The condensation of vapors of immiscible liquids on vertical tubes.*

Kenneth O. Beatty, Jr., 1946, DLK. *Condensation of vapors on finned tubes.*

Nicholas Fatica, 1947, DLK. *Dropwise condensation.*

George W. Govier, 1949, RRW. *Heat transfer and pressure drop for superheated steam flowing in plain and modified annuli.*

Richard N. Lyon, 1949, DLK. *Heat transfer at high fluxes in confined spaces.*

1950s

James G. Knudsen, 1950, DLK. *Heat transfer, friction and velocity gradients in annuli containing plain and finned tubes.*

Donald B. Robinson, 1950, DLK. *Effect of vapor agitation on boiling coefficients at low temperature differences.*

Joseph L. Schweppe, 1950, ASF. *The effect of forced-circulation rate on boiling heat transfer and pressure drop in a short vertical tube.*

Richard N. Bartholomew, 1951, DLK. *Heat transfer from a metal surface to fixed fluidized beds of fine particles.*

Jacob Eichhorn, 1951, RRW. *Heat transfer and pressure drop in systems of gases and solids in fixed and fluidized beds.*

Stuart W. Churchill, 1952, JCB. *Convective heat transfer from a gas stream at high temperature to a cylinder normal to the flow.*

Claude Corty, 1952, ASF. *Surface variables in boiling.*



Anemometer used in finned-tube wind-tunnel tests, 1955.

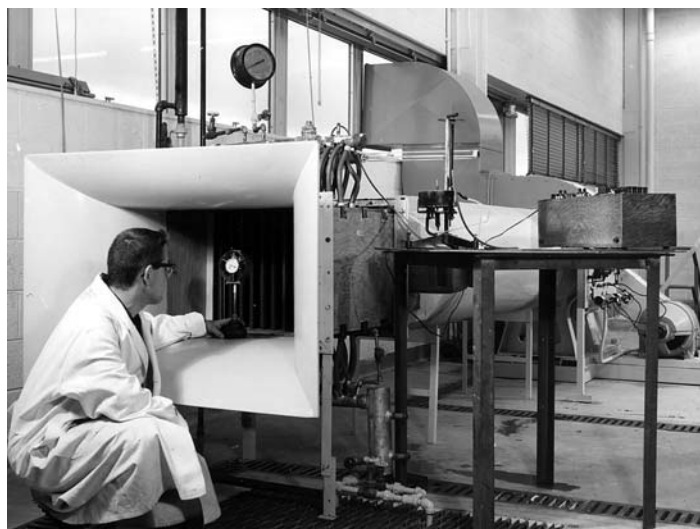

U-M Chem/Met graduate booklet, Dec. 1959

Michael Humenick works on the induced-draft finned-tube heat-transfer project. The equipment was built by Dennis J. Ward, for measuring air coefficients on high-finned tubes, as used in air coolers with air velocities from 200–3,000 ft/min.

John E. Myers, 1952, DLK. *The effects of fluid properties on boiling coefficients.*

Robert Lyon, 1952, DLK. *Experimental boiling rates for liquid metals.*

Robert D. Pierce, 1955, JJM. *Heat transfer and fluid dynamics in mercury-water spray columns.*

Russell B. Mesler, 1956, JTB. *Effect of pressure on nucleate boiling.*

Charles A. Sleicher, Jr., 1956, DLK. *Heat and mass transfer from non-isothermal surfaces.*

Peter H. Abbrecht, 1957, SWC. *Effect of initial velocity distribution on heat transfer in smooth tubes.*



Concentric-pipe heat exchanger is a 9-ft test length fabricated from 2-in. pipe, used for studying heat transfer and pressure drop characteristics of the inside of tubes with internal extended surfaces or turbulators.

Garen Balekjian, 1957, DLK. *The condensation of superheated Freon-114 and steam vapors outside a horizontal tube.*

Eugene R. Elzinga, Jr., 1957, JTB. *Heat transfer to liquid drops.*

Rajeshwar K. Gupta, 1957, DLK. *Use of flow patterns in predicting shell-side heat-transfer coefficients for baffled shell-and-tube heat exchangers.*

Bert K. Larkin, 1957, SWC. *A study of the rate of thermal radiation through porous insulating materials.*

William R. Martini, 1957, SWC. *Natural convection inside a horizontal cylinder.*

Herbert E. Zellnik, 1957, SWC. *Heat transfer from high-temperature gases inside circular tubes.*

Donald W. Sundstrom, 1958, SWC. *Heat transfer from gas flames in cooled tubes.*

Dennis J. Ward, 1958, EHY. *Heat transfer and pressure drop of air in forced convection across triangular-pitch banks of finned tubes.*

Harry E. Stubbs, 1959, SWC. *Heat and momentum transfer from the wall of a porous tube.*

1960s

Jesse D. Hellums, 1960, SWC. *Finite-difference computation of natural convection heat transfer.*

John Chun-Chien Chen, 1960, SWC. *Radiant heat transfer in packed media.*



John G. Lavin and Dale E. Briggs, measuring heat-transfer rates and bond resistances of finned tubes at high temperatures.

Marvin L. Katz, 1960, MRT. *Fluid flow and heat transfer in stratified systems.*

Joachim R. Sinek, 1961, EHY. *Heat transfer in falling-film LTV evaporators.*

William N. Zartman, 1960, SWC. *Heat transfer from acoustically resonating gas flames in a cylindrical burner.*

Lawrence B. Evans, 1962, SWC. *The effect of axial turbulence promoters on heat transfer and pressure drop inside a tube.*

James O. Wilkes, 1963, SWC. *The finite-difference computation of natural convection in an enclosed rectangular cavity.*

Charles P. Colver, 1963, REB. *A study of saturated pool boiling of potassium up to burnout heat fluxes.*

George R. Chludzinski, 1964, RHK. *Energy transfer to solids in RF-generated plasmas.*

John G. Lavin, 1964, EHY. *Heat transfer to refrigerants boiling inside plain tubes and tubes with internal turbulators.*

Robert E. Barry, 1965, REB. *Condensation of sodium at high heat fluxes.*

D. Grant Fisher, 1965, RHK. *Frequency response of flow forced heat exchangers.*

Michael R. Samuels, 1965, SWC. *Stability of a fluid in a long horizontal rectangular cylinder heated from below.*

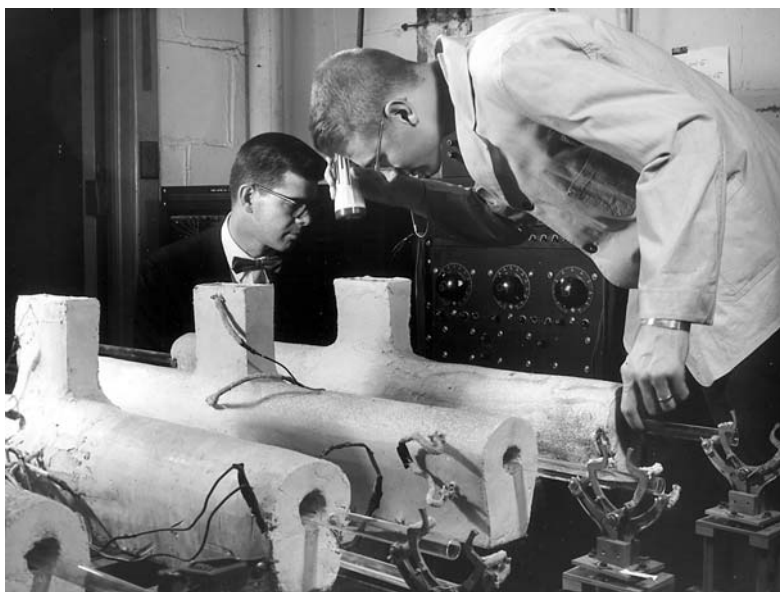

U-M Chem/Met graduate booklet, Nov. 1961

Prof. Donald R. Mason and Phillip Smith, inspecting the operation of a zone-refining apparatus for the preparation of semi-conducting materials for testing electrical properties. Similar equipment was used by Andrew Teller for his 1966 dissertation.

Dudley A. Saville, 1966, SWC. *A boundary-layer analysis of heat and mass transfer in free convection around horizontal, cylindrical bodies.*

Andrew Padilla, 1966, REB. *Film boiling of potassium on a horizontal plate.*

Andrew S. Teller, 1966, DRM/JOW. *Heat transfer in solidifying bars.*

Thomas I. McSweeney, 1967, REB/JOW. *Bubble growth on a glass surface during boiling of ethyl alcohol and toluene.*

Dale E. Briggs, 1968, REB. *Thermal conductivity of potassium vapor.*

Anthony Sartor, 1968, REB. *Condensing heat transfer considerations relevant to rubidium and other alkali metals.*

Li-Chiu Tien, 1968, JOW. *Freezing of a convective liquid in a crystal-growth tube.*

Yan-Jeong Lao, 1969, REB/Barry. *A study of film boiling on a horizontal plate.*

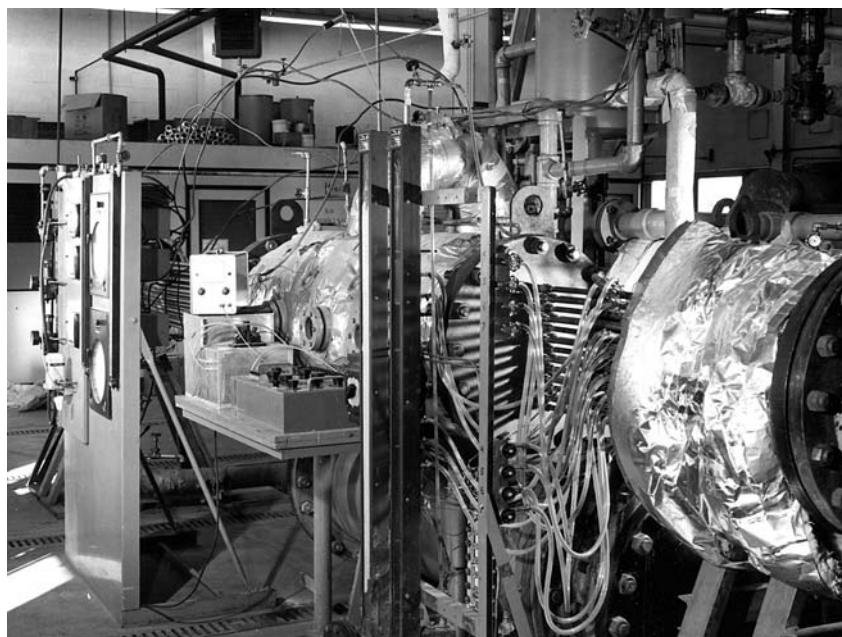

Equipment for investigating the condensation of steam on horizontal single-helix corrugated tubes, sponsored by the UOP Wolverine Division, June 1975. Investigators included Prof. Edwin H. Young, William B. Lampert III, Robert H. Griffiths, Jr., Paul A. Anderson, Louis W. Hruska, Michael J. Paivinen, James C. McCague, James C. Eagleton, and Steven M. Collier.

1970s

Finis E. Carleton III, 1970, RHK. *Flow patterns in a confined plasma jet.*

Robert L. Gahman, 1970, REB/EHH. *Effect of heterogeneous surfaces on nucleate pool boiling.*

George T.S. Chen, 1972, EHY/JLY. *Direct contact heat transfer of a co-*

current oil/water system.

Byung Woo Rhee, 1972, EHY. *Heat transfer to boiling refrigerants R-12 and R-22 flowing inside a plain copper tube.*

Chi-Bao Miaw, 1978, JHH. *A study of heat transfer to dilute polymer solutions in nucleate pool boiling.*

Antonio Valle, 1979, JOW/RDP. *The finite-element method and the Stefan problem.*



William B. Lampert III, Edwin H. Young, and B.W. Rhee.

1980s

John C. Ulicny, 1984, JHH/JOW. *Nucleate pool boiling in dilute polymer solutions.*

William B. Lampert, III, 1985, EHY. *Falling-film heat transfer on vertical doubly fluted tubes.*

Abdulrahman I. Al-Tamimi, 1982, DEB. *Performance of a flat-plate solar collector in a closed-loop thermosiphon using Refrigerant-11.*

Michael J. Beffel, 1986, JOW. *Finite-element investigations into the general energy equation.*

Jorge Emmanuel, 1988, EHY. *Heat-transfer enhancement and two-phase fluid dynamics of dilute polymer solutions.*

Elizabeth C. Batesole, 1993, JOW. *Temperature and pressure distributions of natural gas in aquifer storage reservoirs.*

CATALYSIS RESEARCH AND TEACHING

by Johannes W. Schwank

The Parravano Years

THE central figure in developing a leading catalysis research program at Michigan was Giuseppe Parravano. Born in Florence, Italy, in 1917, he earned two Ph.D. degrees—in chemistry and in electrical engineering—from the University of Rome, where he worked with Dr. Giulio Natta. Their collaboration resulted in two patents for selective hydrogenation of acetylene to ethylene. In 1963 Dr. Natta received together with Ziegler the chemistry Nobel prize for the discovery of the catalytic reactions of α -olefins to give stereoregular polymers, one of the most significant contributions to catalytic science and technology.

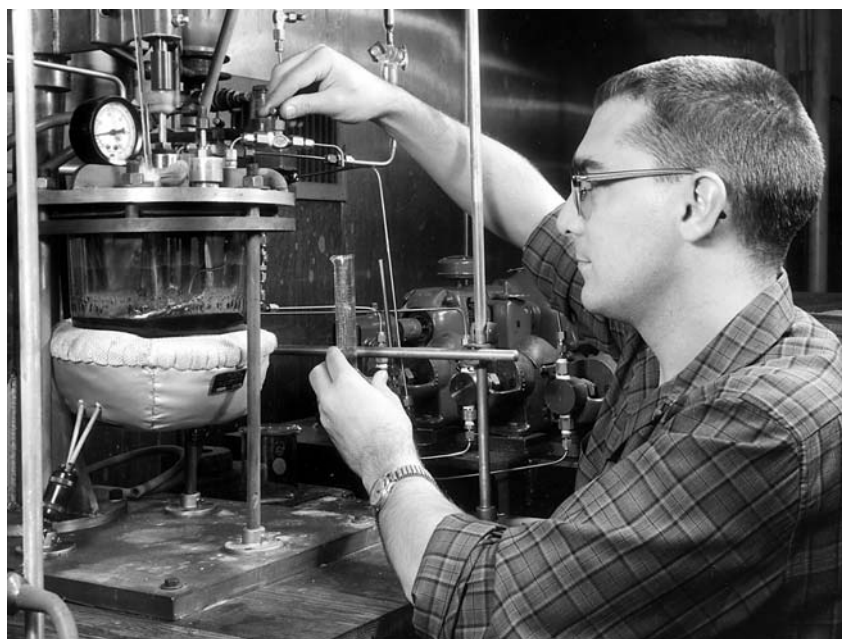

U-M Chem/Met graduate booklet, Nov. 1961

Fred Otto, withdrawing a sample from a polymerization reactor. His study covered the kinetics of formation of stereo-specific polystyrene and the molecular-weight distribution and properties of the product. Otto's 1963 dissertation title was "An Investigation of the Stereo-specific Polymerization of Styrene with Ziegler-Natta Catalysts."

After World War II, Italy's research infrastructure was severely damaged, prompting Giuseppe Parravano to move to the United States, where he started out in 1946 as a postdoctoral research associate at Princeton University's Forre-

stal Research Center, working with Hugh S. Taylor, one of the great pioneers in the early days of catalysis research who proposed in 1925 the concept of catalytically active sites for metals, and with Michel Boudart, who later became a professor at Stanford University. In 1952, Giuseppe Parravano took a position as principal scientist at the Franklin Institute in Philadelphia, and moved in 1955 to the University of Notre Dame in Indiana as an associate professor. In 1958, he joined the faculty at the University of Michigan as an associate professor in the Chemical and Metallurgical Engineering Department.



U-M Chem/Met graduate booklet, Nov. 1961

Jude Sommerfeld, measuring the chemisorption of oxygen on ruthenium oxide, as part of a program for determining the activities of industrial oxidation catalysts. He worked with Prof. Parravano, and received his Ph.D. in 1963.

Giuseppe Parravano's research at Michigan started out with a research contract from the United States Air Force to examine the role of solid-state reactions in the sintering of oxides, with special emphasis on the role of filamentary growth on sintering of high surface-area catalysts. He set up laboratory facilities on the third floor of the East Engineering Building, which he equipped with one-of-a-kind

custom-built high-vacuum glass apparatus and flow reactors for the characterization of catalysts. The experimental methods and reactor designs Giuseppe Parravano used showed a strong influence of the Russian school of catalysis, developed by Roginski, Balandin, and Boreskov. Over the years, Giuseppe Parravano also maintained a close interaction and lively correspondence with Carl Wagner from the Max Planck Institute for Physical Chemistry in Göttingen, Germany.

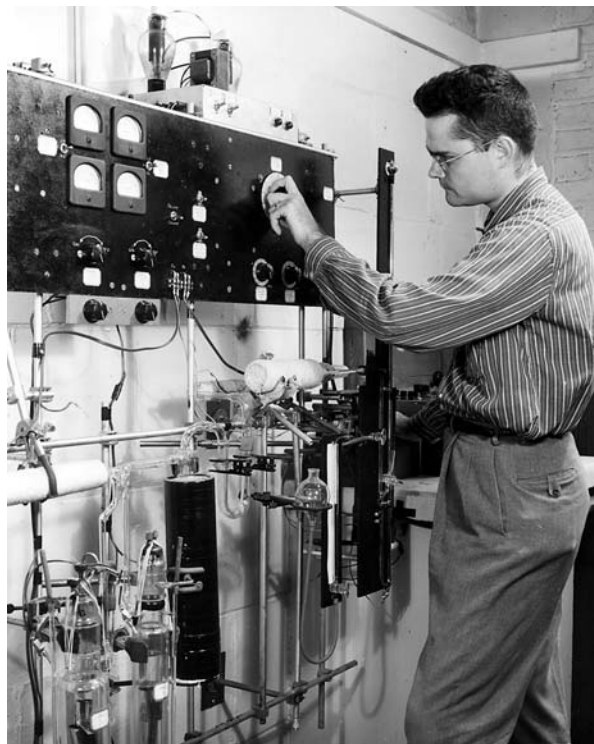

U-M Chem/Met graduate booklet, Dec. 1959.

Robert G. Squires, studying electrical properties of particulate semi-conducting materials. His 1962 doctoral dissertation (with Prof. Parravano) was “The effect of changes in catalyst composition on the hydrogen/deuterium exchange reaction on cobalt ferrite.”

Parravano pioneered and promoted several novel experimental methods for the investigation of adsorption and reactivity at solid surfaces, such as the use of chemical relaxation times to elucidate surface kinetics, and isotopic exchange reactions to explore the mechanistic aspects of hydrogen and oxygen transfer reactions. He also made important contributions to the electrochemical initiation of polymerization reactions, and was one of the first to recognize the potential of studying the

transient response of chemically interacting solid-gas systems. He was an ardent advocate of the view that the chemical engineering profession must continually strive to apply the principles of chemistry and materials science in imaginative ways to develop new technologies. His research and graduate teaching straddled the interdisciplinary interface between reaction engineering, solid-state chemistry and physics, surface science, and materials science, to lay the proper foundation for a systematic approach to heterogeneous catalysis. Historically, catalysis research tended to focus on adsorption phenomena and surface kinetics, with emphasis on the gas and liquid phases in contact with the catalyst. The role of the solid was often not fully taken into account for lack of theoretical understanding of solid-state properties and reactivity. Giuseppe Parravano was one of the key players in developing a rational basis for the study of the role of the solid phase in catalysis, thus laying the ground for a quantitative, atomic-level description of the reactivity of catalytic surfaces.

When Giuseppe Parravano suddenly passed away at the age of 60 on April 1, 1978, the regents of the University of Michigan issued a memorial statement that captures the essence of his teaching and research at Michigan: “. . . Professor Parravano’s research activities and publications reflect his own characteristic combination of personal qualities—the insightful judgment of the professional, together with the imaginative verve of the gifted amateur. As an academician, he truly lived his philosophy that research and teaching are inseparable components of post-graduate education. His values and spirit would lead him to collect new pebbles from the water’s edge, rather than to polish gems long since found.”

Giuseppe Parravano’s legacy includes many Ph.D. and postdoctoral students who carried the work forward and established successful academic careers of their own at other institutions, such as W. Nicholas Delgass and Robert Squires at Purdue University, Jude Sommerfeld at Georgia Tech, James G. Goodwin, Jr., at the University of Pittsburgh, and Signorino Galvagno at the University of Messina in Italy.

Catalysis Since 1978

Since 1978, catalysis research at the University of Michigan has substantially expanded with the addition of several faculty members working in this research area. Professor Parravano’s last post doctoral student, Johannes Schwank, became in 1980 a faculty member at the University of Michigan, thus ensuring continuity in our catalysis research program. His work focused on correlating the structure and composition of catalytic surfaces with their reactivity in hydrogen and oxygen transfer reactions. A major new theme evolving was the characterization of supported bimetallic catalysts by analytical and high-resolution electron microscopy. More recently, an interdisciplinary research effort has led to the development of microelectronic gas sensors.

Professor Gulari joined our department in 1978 after working for several years in industry. His research is primarily concerned with molecular-level investigations of phenomena occurring at liquid/liquid, liquid/solid, and gas/solid interfaces, including enzyme-catalyzed reactions that occur at the organic/aqueous solution interfaces. Work on gas/solid systems has addressed the kinetics of adsorption and catalytic oxidation of simple molecules such as CO on noble metals and reducible metal oxides and the Fischer Tropsch synthesis. Currently the most active area of Professor Gulari's research is in electronic materials. He has extended the use of hot-filament catalysis to the deposition of amorphous, polycrystalline, and epitaxial films for use as dielectric or protective coatings in electronics, hard coatings, and thin-film transistors and lasers.



James G. Goodwin (Ph.D. 1976), involved in his research into the decarburization of Fe thin films by hydrogen, working with Prof. Parravano. The equipment used a Mössbauer spectrometer to detect conversion electrons. Using this detection system, the nature of the carbides present and their amounts could be determined as a function of time and temperature.

Professor Levi Thompson's research focuses on the rational design, engineering, and characterization of advanced catalytic and electronic materials, including early transition metal nitrides and carbides, aerogels, organometallic cluster-

derived materials, and metastable materials. He joined Michigan's Chemical Engineering Department in 1988 and received a NSF Young Investigator award.

In 1988, Professor John Gland was given a joint appointment in the Chemistry and Chemical Engineering Departments. He had worked for nine years at General Motors Research and subsequently headed the Surface Science Group at Exxon's Corporate Research Laboratory, before moving into academia. His main research interests are surface chemistry and catalysis, ultra-soft x-ray spectroscopy, and thin-film gas sensors. Professor Yang joined the University of Michigan in 1995 after serving on the faculty of the State University of New York (SUNY) for 17 years, and as department chair for five years. His catalysis research projects deal with the selective catalytic reduction of NO with ammonia, a process that is being commercialized in the U.S. for power-plant emission control, and with the kinetics and mechanisms of gas-carbon reactions.

On the reaction-engineering front, Professor Fogler's and Savage's work ties in closely with catalysis, and both have catalysis-related research projects under way. For example, Professor Fogler has worked on catalyzed dissolution of minerals by solutions, and Professor Savage has studied the thermal and catalytic reactions occurring during heavy-oil upgrading and coal liquefaction.

As far as formal classroom teaching is concerned, catalysis has primarily been a graduate course topic. Over the years, two courses have been offered, one entitled *Catalysis, Kinetics, and Research Reactors*, the other one *Industrial Catalysis*. A brief introduction to catalysis has been given in the context of the undergraduate reaction engineering course, using Professor Fogler's textbook *Elements of Chemical Reaction Engineering*.



ANOTHER MICHIGAN FIRST—LIGHT SCATTERING

by Cedomir M. Sliepcevich†

OVER my four decades of directing graduate student research—the first seven years at Michigan and the remainder at the University of Oklahoma—I had the privilege of having 70 students (15 at Michigan) complete their Ph.D. dissertations. Although by and large their contributions were quite creditable, the most outstanding accomplishments were by my second doctoral student, Roland O. Gumprecht, whose dissertation title was *Particle Size Measurements by Light Scattering*. At the onset, my relationship with Gumprecht was a classic example of the “blind leading the blind”; if it were not for this state of blissful ignorance we undoubtedly would not have undertaken this program in February 1948. Up to this point, my experience and knowledge in particle-size measurements was confined to qualitative comparisons of screening smokes by light-transmission measurements during 1942. In 1948, I had less than a vague familiarity with the Mie theory of light scattering and at this point Gumprecht was in the same boat. Nevertheless, since we had an exciting challenge to meet on discharging smoke from a V-2 rocket after burnout for studying upper atmospheric winds and turbulence, we forged ahead. Briefly, here is what Gumprecht accomplished.

1. He extended the Mie theory of light scattering from particles on the order of one micron in diameter or less, to particles of diameter 60 microns. The extension to these larger particles represented an enormous computational undertaking and would not have been attainable without the advent of electronic computers. Originally, Gumprecht started out using the IBM Model 602-A calculating punch, located in the basement of the Horace H. Rackham Building. This calculator was an electromechanical device for which programming consisted of devising about a dozen control-panel wiring boards (similar to the telephone switchboards of that era). Although the 602-A reduced the computational time for one man working 40 hours per week with a desk calculator from 25 years to 5 years, it became clear that this approach was unrealistic. Fortunately, the ENIAC electronic computer at Aberdeen Proving Ground had recently come on line. To this point the ENIAC was strictly reserved for defense work. Although our work on extending the Mie theory did not fall under this category, it was judged sufficiently important to allocate ENIAC time. The fact that several prominent scientists, primarily Nobel prize winner P. Debye, Michael Ference (chief scientist at Evans Signal Laboratory), David Sinclair, and others were interested in our work really secured our allocation of time—less than two weeks—on the ENIAC. The end result was our publication of three volumes of mathematical tables on light-scattering functions, Riccati-Bessel functions, and partial derivatives of Legendre polynomials.

2. The experimental verification of the extension of the Mie theory to larger

† September 30, 1997.

particles required the development of a unique optical system. The major stumbling blocks were the need to conceive, design and build special electronic devices that were unavailable on the market, primarily regulated power supplies, a high-gain amplifier, a unique optical bench, and a technique for producing glass beads up to 50 microns in diameter and in uniform-size dispersions. Gumprecht was successful in extending the Mie theory mathematically and validating its application to large particles experimentally. To my knowledge, Gumprecht's work represents the first doctoral thesis anywhere that became possible via electronic computation.

EARLY BIOMEDICAL RESEARCH

by Cedomir M. Sliepcevic†

DURING the early 1940s a close student friend of mine (George Morley, for whom a professorship in gynecology at the University of Michigan Medical School was established a few years ago) was working on research projects at the Medical School preparatory to his admission as a student in medicine. On a number of occasions he would discuss his research with me; I welcomed the opportunity since in the back of my mind I was still toying with the possibility of working on an M.D. instead of a Ph.D. in engineering. George also invited me to some of their research staff meetings, which gave me an opportunity to become acquainted with more of the faculty and their research interests.

These extra-curricular activities stimulated my interests enough for me to start poring through Best's *Physiology* and Gray's *Anatomy*, which convinced me that there were opportunities for engineers to play—at least supporting roles—in medical research beyond routine technician and instrumentation assistance. Some of the faculty in metallurgical engineering had already been involved, voluntarily, from time to time with the specification or development of materials—usually metals—that would be compatible when used as supports or fasteners in the interior of the human body. Another area in which they cooperated was the advancement of x-ray technology. During this period I also participated in a number of small projects mostly related to data analysis and correlations.

In 1948, while discussing possible dissertation topics with one of our doctoral students in chemical engineering, Phil Bocquet, it became evident that he was not interested particularly in any of the ongoing research in the department. When we got off into a discussion of interdepartmental research, I could see that we were making headway. When I included medically related research, Phil was hooked. Subsequently, meetings with Dr. Sibley W. Hoobler of the Medical School and Dr. David F. Bohr of the Physiology Department resulted in Phil undertaking an investigation of the possibility of using the streaming potential concept as a

† September 30, 1997.

measure of the blood flow, in-vivo, in remote regions of the body, particularly in and near the heart as originally suggested by Dr. W. John Kenfield. In order to meet the chemical engineering requirements for a thesis, we had to direct the research ostensibly toward a basic study in fluid mechanics. On the other hand, since this study was primarily funded by a research assistantship for Phil Bocquet in physiology from the National Heart Institute, National Institutes of Health, U.S. Public Health Service (1949–1951), and the Michigan Heart Fellowship in chemical engineering (1951–1952), we could not lose sight of the ultimate objective to measure blood flow.

The thesis was brought to a successful completion in the early fall of 1952. A paper covering the fluid mechanics aspects of this study was published in *Industrial and Engineering Chemistry*, **48**, 197 (1956), “Effect of Turbulence on the Streaming Potential,” by P. E. Bocquet, C.M. Sliepceвич, and D.F. Bohr.

The next research project in cooperation with the Medical School was initiated by W. Ernest Henderson as his doctoral thesis in chemical engineering in 1951. From the standpoint of the Medical School, the objective was to develop a flat-plate dialysis unit that could be used as an artificial kidney. On the other hand, to satisfy the requirements in chemical engineering, a mass-transfer study was simultaneously undertaken to investigate ultrafiltration of solutions of non-electrolytes through porous membranes to quantify the factors that control the effectiveness of separation. The aqueous solutions selected for study were dextrose, sucrose, and raffinose, and the membranes were made from regenerated cellulose. While the experimental apparatus for the ultrafiltration studies was erected in the chemical engineering laboratories, another unit for dialysis studies was designed and mounted on an angle iron framework having casters for portability. The latter was completely instrumented and self-contained for artificial kidney studies at the Medical School. In fact, successful test runs on actual patients suffering from kidney failure were performed. In these tests the medical doctors attached the tubes leading to and from the dialysis unit, but thereafter the chemical engineers (primarily Ernie Henderson and his wife, Ann, a graduate biochemist) operated the dialysis unit and monitored clotting for heparin injections while doctors and nurses observed. Upon completion of these successful tests at the Medical School, this dialysis unit continued to be used for years as a research device, primarily as a clinical device for separating components in the blood. When Wayne Medical School requested a similar device for their clinic, George Foster, chief machinist in chemical engineering who had built the first unit for Henderson, volunteered his time—working evenings and weekends—to build a duplicate unit for Wayne Medical School.

Henderson’s thesis work was summarized in *Chemical Engineering Progress Symposium Series*, **55** (24) 145 (1959), “Molecular Separations by Solution Ultrafiltration,” by W.E. Henderson and C.M. Sliepceвич.

BIOTECHNOLOGY AND BIOENGINEERING

by **George T. Tsao, Stacy L. Daniels,
Jerome S. Schultz, and Henry Y. Wang**

Introduction

THE Department of Chemical Engineering at the University of Michigan has a long history in biotechnology and bioengineering. Professor Brymer Williams told us the story on how this field was started. Professor Lloyd L. Kempe was actually initially recruited at the U–M as a professor in the Department of Bacteriology. It was primarily due to some former World War II G.I. students who listened to Professor Kempe’s lectures and recommended him to Professor G.G. Brown, who subsequently invited Professor Kempe to join our department. Therefore, the origin of this research and training focus in chemical engineering should be credited to the former students as well as to the professors involved. In the early days, Professor Kempe was the only person involved in biochemical engineering, with a strong emphasis on applied and industrial microbiology. Since then, the program has gone through many twists and turns but has grown nonetheless. The narrative accounts of the experience by two former students and two past and current faculty members are used to illustrate the past and enriched history of biotechnology and bioengineering program at the U–M.

From Professor George T. Tsao, Purdue University†

“In the summer of 1956, I arrived at the Main Campus of the University of Michigan as a new graduate student. At that time, the Department of Chemical and Metallurgical Engineering was housed in the old building that was across the street from the old Civil Engineering Building. It was on the same block but next to the building where the Department of Bacteriology of the Medical School was located. Through a photographic picture in one of the department documents, I was able to recognize Professor Lloyd Kempe, my future major professor, when I was just walking on the street leading towards the building where I had always dreamed about as a place to study advanced chemical engineering subjects. After a brief self-introduction right on the street, I started my career at the U–M under Professor Kempe.

† Professor Tsao is professor and director of the Laboratory of Renewable Resources Engineering (LORRE) at Purdue University. He received his Ph.D. in chemical engineering and a minor in biochemistry and microbiology from the U–M in 1960. He is a pioneer in the fields of renewable resources engineering and biochemical engineering. Many of his past graduates are now themselves holding important positions in academia, industries, and governments. He received the David Perlman Lectureship Award in 1986, the Marvin Johnson Research Award in 1987, and the John Ericsson Award for “Outstanding Achievement” in Renewable Energy from DOE in 1988. He has been a founding fellow in the American Institute of Medical and Biological Engineering since 1992.

At the time, Lloyd Kempe held a split appointment between chemical engineering and bacteriology. The proximity of the two buildings (East Medical and East Engineering) obviously had made the arrangement very nice and workable. By the time I graduated from the U–M with a Ph.D. degree in January, 1960, the Chemical and Metallurgical Engineering Department was still on the Main Campus. The so-called “North Campus” was under construction and there were only a few units of operation located there. My research projects were located either in the chemical engineering building or the bacteriology building and there was little reason for Prof. Kempe even to visit the North Campus.



U–M Chem/Met graduate booklet, Dec. 1959

Prof. Lloyd L. Kempe and George T. Tsao, examining an agitated fermentation bath.

Professor Kempe had a fairly diverse group of graduate students working under his supervision during those years. Robert A. Gillies might have been Lloyd’s very first graduate student. Dr. Gillies had already graduated and left the campus when I arrived. Gillies’s work on lactic acid fermentation was continued by Alberto E. Molini and Ronald E. West. I did not work on lactic acid as my thesis topic but I did study the effects of growth factors in yeast extracts on lactic acid productivity and also the method of recovery of lactic acid by steam distillation. Dr. Molini came from Puerto Rico and went back there after graduation from the U–M. He

later became the head of the Department of Chemical Engineering of the University of Puerto Rico and passed away fairly recently. Dr. West joined the University of Colorado after graduation and has been there ever since. I left the U–M in 1960 and joined Merck and Co. Inc. and overlapped with a newcomer, Gary F. Bennett. Gary is now a professor emeritus of the Department of Chemical Engineering of the University of Toledo, where he has spent his entire career. He is still active as the editor of the journal *Environmental Progress*.



George T. Tsao

students of Kempe, and others.

At the time, Professor Phil Gerhardt of the Department of Bacteriology at the U–M was also involved in research on lactic-acid fermentation. Phil’s membrane fermentor for enhanced lactic-acid production was one of the earliest examples of the benefits of simultaneous membrane transport and a bioreaction system.

Besides the chemical engineering graduate students, Professor Kempe also had a number of graduate students from the Department of Bacteriology. In those years, he had a long-term contract from the Department of Defense on sterilization of food, particularly beef cans, with heat and gamma radiation. Even though radiation sterilization was never employed on a large scale for food processing, in the 1950s, it was closely examined for possible applications. Robert A. Gillies and I also worked on the canned-meat project even though that was not our thesis topic. In addition, Jack T. Graikoski and Peter F. Bonventre studied sterilization of canned beef and that was their thesis work. In this project, the canned ground beef was purposely inoculated with spores of *Clostridium botulinum*. After different dosages of gamma irradiation and different days of incubation, some cans remained well sterilized and some obviously did not. As a part of the research, those spoiled cans were to be opened to make viable cell counts, and this was when the whole bacteriology building would stink like hell. Through pipetting, Peter Bonventre

Lactic acid was also the subject of thesis research of Lloyd Kempe himself when he was a student of Professor E.L. Piret of the University of Minnesota. At the time, Professor Robert K. Finn was on the faculty of the University of Illinois. Finn and Kempe were both Piret’s graduate students. The work on lactic acid was almost like a common denominator that ran through the “family tree.” In those days, there were only a few biochemical engineering “families.” One ran from Elmer Gaden to Arthur Humphrey and Jerry Schultz and then Daniel Wang, Peter Reilly and others in the east. And the midwest family went from Piret to Lloyd Kempe, R.K. Finn, and Robert Leudeking and then to Molini, West, Tsao, Bennett, and Daniels, stu-

once got a little of the diluted botulinum toxin into his mouth and was out in the hospital for nearly three weeks.

Professor Kempe had research interests in lactic acid and gamma radiation. In addition, he was very much involved in monitoring environmental contamination by some wastes. I started a new research area on oxygen transfer in fermentation processes. Those were the days before the DO analyzers were invented. How to measure the oxygen transfer rate besides the questionable sulfite oxidation method was a problem. Work on oxygen transfer was continued by Gary Bennett as his thesis topic and later by Dan Bull.



Lloyd L. Kempe

I was recruited to join the Department of Chemical and Metallurgical Engineering by Lloyd Kempe, who had made significant contributions in the field of sterilization, particularly using radiation sterilization for the protection of foods. He also was one of the early researchers who showed how to design high-temperature short-time processes for food treatment. By using higher temperatures than the normal 220 °F and very short exposure times, he showed that one could maintain the taste of foods that tended to be degraded by the longer exposures in the conventional sterilization processes.”

From Dr. Stacy L. Daniels, University of Michigan (formerly, Dow Chemical Company)†

“I began my association with the department (it was then called Chemical and Metallurgical Engineering) in the fall of 1955. Twelve years, 91 courses, 256 credit hours, and many tuition dollars later, I left with a brightly minted Ph.D. in biochemical engineering, finally to work for a living. In between, I interacted

† After retirement from the Dow Chemical Co. with 30 years of service, Dr. Daniels has been an adjunct professor in both the Chemical Engineering and Civil & Environmental Engineering Departments at the University of Michigan. He has taught a course *Waste Management and Hazardous Waste Processes*, and since 1970 has often assisted in teaching the courses *Chemical Engineering of Water*, *Air Pollution Control*, and *Microbiology for Engineers*. He received his B.S.E., M.S.E., and Ph.D. (1967) in chemical engineering and an M.S.E. in environmental engineering from the University of Michigan. His long career with the Dow Chemical Co. encompassed environmental research, product/process development, health and environmental sciences, hazardous waste management, combustion engineering, and regulatory compliance. He is currently director of research for Quality Air of Midland, Inc., a small business designing HVAC systems for chemical/biological laboratories. His research interests include bacterial adsorption, coagulation and flocculation, hazardous-waste management, combustion and incineration, watershed management, and indoor air quality. He is actively involved with government and academic science advisory committees. A charter member of the Environmental Division of AIChE, he received the Larry K. Cecil Award in 1979.

with some very knowledgeable (and demanding) chemical engineering faculty who forever imprinted me with the U–M stamp. I had the great fortune as an undergraduate to take the unit operations course from Professor Lloyd L. Kempe, who instilled in me a passionate and continuing interest in biochemical engineering. He became my mentor and eventually my doctoral chairperson. Specialized courses in biochemical engineering at the time included fermentation processes and food processing, augmented by bacteriology for engineers, industrial microbiology, sanitary microbiology, bacterial physiology, biochemistry, stream sanitation, limnology, and industrial waste treatment.



James Wilkes

Stacy Daniels, Lloyd Kempe, and Gary Bennett, at Lloyd Kempe's retirement celebrations, Michigan League, 5 December 1980.

Dr. Kempe, with joint appointments between the Chemical Engineering and Bacteriology Departments and subsequently with the Civil Engineering Department, taught several of these courses. Many chemical engineering students learned from the “Doc” that microorganisms did lots of interesting things. His biochemical design course gave us a feel for treating wastewater, producing antibiotics, and converting algae to “food.” I learned to appreciate aseptic techniques when I conducted a favorite experiment in his course *Microbiology for Engineers*. We exposed open Petri dishes of blood agar on windowsills and watched microbes grow prolifically on the “invisible” tracks of flies across the surfaces. My Ph.D. thesis was centered on the separation of microbes using ion-exchange resins, a subject I started as an undergraduate research project. I well remember my first successful separation of cells of two different bacterial species. Lloyd excitedly invited Professor Stu Churchill, then the department chairman, to visit our lab to see biochemical

engineering in action! I had the capable assistance of several ChE master's degree students finally to obtain electron micrographs of the phenomenon.

In the early 1960s, the Biochemical Engineering Laboratory moved from the fourth floor of East Engineering to the new G.G. Brown Building on the North Campus. The unit operations laboratory (called Chemco, Inc.!, the predecessor of the infamous G.G. Brown Industries) included the fermentation of molasses to ethyl alcohol (with a 108% yield!). Gary Bennett, Dan Bull, and I were the first Ph.D. candidates in Dr. Kempe's new laboratory, assembling a walk-in incubator and other gadgets for state-of-the-art studies of the growth and behavior of microorganisms. Several of us also benefited by working with Dr. Kempe at the Bureau of Commercial Fisheries (BCF) on the sea-lamprey control program directed by Dr. Al Beeton, who later went on to become the chief scientist at NOAA. At the BCF, we outfitted a new chemical laboratory, conducted original field research, and presented our first papers at national meetings. We also did a "tour of duty" on a converted minesweeper while learning the fundamentals of water sampling on the high inland seas of Lake Erie.

Gary Bennett, who is the long-time editor of *Environmental Progress* and was awarded the Larry K. Cecil Environmental Award from the Chemical Engineering Environmental Division of the AIChE, is now a professor emeritus of biochemical engineering at the University of Toledo. Dan Bull went on to an illustrious career in the pharmaceutical industry.

The bio-engineering program options at the University of Michigan have gone through many changes since my student days. The disciplines have moved from conventional to high technology as the methodologies have evolved from tedious and empirical one-data-point-at-a-time approaches to computerized data collection and evaluation. The focus now covers biochemical, bioenvironmental, and biomedical engineering education and research. All appear alive and well indeed!"

From Professor Jerome S. Schultz, University of Pittsburgh†

"My appointment at the U-M was intended to extend the scope of the biochemical engineering program beyond Lloyd Kempe's interest in sterilization. I had been trained in chemical engineering by Elmer Gaden at Columbia University (Dr. Gaden is sometimes credited as being the father of biochemical engineering), where I worked on the mechanism of oxygen transport as related to the aeration of fermentors. I completed my doctorate in biochemistry with Marvin Johnson at the

† Professor Schultz did his undergraduate work at Columbia University and his graduate work at Wisconsin. His contributions to the field of bioengineering while on the faculty of the Department of Chemical Engineering at Michigan were recognized by the College of Engineering's Research Award in 1983, the AIChE Food, Pharmaceutical and Bioengineering Award in 1984, and his selection as a member of the NIH Study Section on Surgery and Bioengineering from 1984 to 1988. Later, he was elected as a founding fellow of the American Institute for Medical and Biological Engineering in 1992, and to the National Academy of Engineering in 1994.

University of Wisconsin. Dr. Johnson was a world expert in penicillin production by fermentation and applied engineering techniques to improve the productivity of fermentors by unique concepts such as slow feeding of nutrients throughout the fermentation process. He was the first scientist to recognize that the production of secondary metabolites by microorganisms is not growth associated. After my Ph.D., I joined Lederle Laboratories, where I was a group leader in charge of fermentation development in the Research Department. At Lederle I worked with Ping Shu to demonstrate that one could scale up the production of antibiotics by forcing the cells in the tank scale to duplicate the oxygen consumption pattern by the cells measured in the shake-flask stage. Thus my expertise was in “bioreactor engineering,” even though that term didn’t exist in the early 1960s.



Jerome S. Schultz with his invention of a glucose sensor optode. The sensor chemistry is encapsulated in a single dialysis fiber sensor chamber placed at the end of a single optical fiber (left hand). The magnitude of fluorescence produced in the sensor chamber is directly related to the glucose concentration in the fluid in which the probe is placed, and is measured by a photometer attached to the other end of the optical fiber (right hand).

At Michigan one of my first assignments was to assist Prof. Kempe in teaching the course *Microbiology for Engineers*. It may seem odd that microbiology was taught in the engineering school. But the circumstances were that the microbiology course in the Biology Department required so many prerequisites that made it impractical for engineers to take it, and the Medical School only offered microbiology for medical students. Thus the Engineering College was forced to

offer microbiology for the sanitary engineering program in the Civil Engineering Department and the biochemical engineering option in the Chemical Engineering Department.

My first research collaboration was with Phillip Gerhardt in the Microbiology Department. Phil had an Army contract to produce pathogenic organisms and bacterial toxins at high concentrations, and he had the innovative idea to create a two-chamber growth system with a dialysis membrane separating the two compartments. The microorganism was placed in one chamber and the nutrients were placed in the other chamber. Nutrients diffused into the culture chamber producing high concentrations of cells; also, since the macromolecular product could not diffuse through the dialysis membrane, high concentrations of product accumulated in the culture chamber. I did the mathematical reactor analysis for this system, the first published analysis of a membrane bioreactor system.

Because of this work with membranes, I became interested in determining the mechanisms by which molecules are sorted by dialysis membranes. At that time, scientists at General Electric had discovered a method of making uniform Angstrom-sized pores in membranes. After a visit to GE to learn the technique, I undertook a study to measure the diffusion of different-sized molecules through these membranes with known pore dimensions. This was the first study of hindered diffusion in the liquid phase (the mechanism of transport of gases through pores had been well understood by that time, e.g. molecular sieves). The results of this study were published in *Science* and led to the opening of a new field of research, which has been pursued by outstanding engineers such as John Anderson at Carnegie Mellon and William Deen at MIT.

My connection with the Bioengineering Program (now the new Biomedical Engineering Department) began to evolve with the appointment of Peter Abbrecht as chairman of the Bioengineering Program. Peter received his Ph.D. in chemical engineering with Stuart Churchill and then went on to obtain a M.D. degree. I joined the Executive Committee of the Bioengineering Program and through that involvement began to interact with physiologists and physicians. This interaction heightened my interest in the biophysics of membranes and also led me to the concept of developing technologies for separations based on biological phenomena. At that time it was speculated, based on kinetic data, that the mechanism for the selectivity of biological membranes was due to a carrier protein that somehow shuttled specific solutes (e.g. glucose, potassium, etc.) across the lipid bilayer membrane. I attempted to make an artificial membrane that had the same characteristics. I used a cobalt/histidine complex (this chelate reversibly binds oxygen) as an analog of hemoglobin to make a membrane that separated oxygen from air. This was one of the earliest reports of a synthetic carrier transport system (later to be called liquid membranes). It was this work on facilitated diffusion, along with my earlier work on transport through pores that was the basis of my Career

Development Award from the NIH. At that time this award was usually given to biologists or physicians; I was the second engineer to get this award—Peter Abbrecht was the first. The CDA paid my complete salary for five years, and thus I had a great opportunity to pursue further research in bioengineering.

My participation in the Bioengineering Program put me into contact with groups in the Department of Surgery and I was asked to help them out on a new initiative that they were developing on artificial organs. The two areas that I focused on were the problem of blood clotting on artificial materials placed in contact with blood (as in heart pumps and blood oxygenators) and the need to develop a glucose sensor for an artificial pancreas. For the first project I assembled a group consisting of engineers (Joe Goddard and Frank Filisko), and physicians (Martin Lindinauer, a surgeon, and John Penner, a hematologist) and we were successful in developing a fluid-mechanically-defined testing system (a rotating rod in axial flow) to evaluate new biomaterials.

To attack the second project—a glucose sensor—I combined my experience with membranes and some knowledge of immunoassays that I learned from my wife (Jane is a immunologist) to make the first optical immunosensor. Interestingly, technology transfer and company generation was not looked on favorably at that time, so Michigan gave its rights to my patent to NIH. Since NIH did not have an active program in CRADAs[†] as they do now, the sensor was never commercialized. However, the concept has taken hold and there have been hundreds of papers on optical biosensors since that time.

When I became chairman of the department I realized that our department could become a national leader in bioengineering particularly if we leveraged our capabilities with other groups in the university—from pharmacy, chemistry, biochemistry, and medicine. We embarked on a search to find exceptional faculty, and selected Henry Wang and Bernhard Palsson, who have admirably carried on the bioengineering tradition in the Chemical Engineering Department.”

From Professor Henry Y. Wang, University of Michigan‡

“In the early 1970s, I was introduced to the field of “Biochemical Engineering” as an undergraduate student at Iowa State University by working in Professor George T. Tsao’s laboratories. George was a U–M alumnus. I still recall helping out his early graduate students, David Marsh (currently at Amoco Chemical) and Y.Y. Lee (currently at Auburn University) to prepare enzyme immobilization onto glass beads. After completing my graduate study at MIT under the joint

[†] Cooperative research and development agreements.

[‡] Professor Wang did his undergraduate study at Iowa State University and his graduate study at MIT. In 1979, he joined the Department of Chemical Engineering at the U–M and is currently a professor of chemical engineering and biomedical engineering. His research interests include extractive fermentations, immobilized cell technologies, and environmental biotechnology.

supervision of Professors Daniel I.C. Wang and Charles Cooney and then spending a few years at Merck & Co. and Schering-Plough in New Jersey, I decided that the academic world was where I really belonged. Professor Jerry Schultz was then the chair of the Chemical Engineering Department at the U-M. He called me and asked me to consider the U-M. I finally decided to come to Michigan primarily for two reasons. First, my sister was studying at that time in the College of Pharmacy and second, I was quite impressed with the teaching and research facilities already in existence to do biochemical engineering work, particularly those in the Engineering 1-A Building (currently EWRE). Only after I arrived did I become aware of the commuting problem between North Campus and Central Campus, which was only resolved after the H.H. Dow Building was completed in 1982.

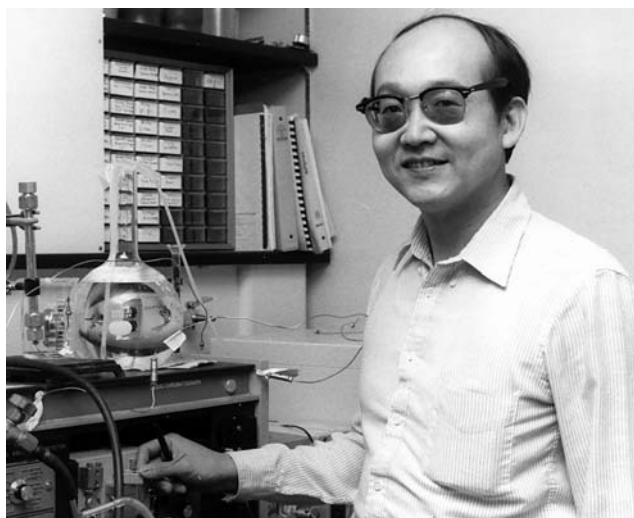

Henry Y. Wang in his laboratory.

One of the options already available to the undergraduate students is the chemical engineering degree with a biochemical engineering option, better known as the “bio-option.” This option does not affect the basic chemical engineering requirements in any way; it merely requires the student to take a few additional courses. I ended up being the only one to teach those courses. It dawned on me much later that it was the main reason that I was hired! The bio-option is geared towards those students who are interested in biochemical and related industries. Since the University of Michigan does not offer an official degree in biochemical engineering, this option is an alternative. It was a very popular option for many undergraduate students. At least 20–30 students graduated from this option every year and were recruited by various companies such as Upjohn, Lilly, Eastman Kodak, General Mills, and Abbott. Some students used this option to gain admission to medical schools without being a pre-med student. The bio-option

was only eliminated in late 1980s when the annual student enrollment in chemical engineering dropped briefly below 60 and the teaching and research facilities were appropriated for the newly funded Great Lakes and Mid-Atlantic Center (GLMAC) for hazardous substance research under the directorship of Professor Walt Weber. Since then, there has been a resurgent interest by the chemical engineering students and the faculty to revive this popular bio-option.

I also started to rebuild an active graduate program in biochemical engineering at the U–M. In collaboration with Dr. William Maxon of the Upjohn Company (Kalamazoo, Michigan) and Professor Michael Savageau of the Department of Microbiology and Immunology in the Medical School, we were successful in receiving one of the early university/industry research grants from NSF on extractive fermentation processes. The inspiration of the work came from an early concept of “dialysis” fermentation proposed by Professors Phil Gerhardt and Jerry Schultz. Solid adsorbents were found to be compatible with various fermentation processes and could be used to increase product yields of many fermentations. It is now a common industrial practice to add various solid adsorbents to evaluate new secondary metabolite fermentation processes. An immobilized yeast cell in calcium alginate system was also developed through a DOE grant. It resulted in an improved method of evaluating yeast-cell viability in commercial yeast fermentations. I learned only recently that the idea of coating immobilized yeast cell beads developed under this grant contract is actually being practiced in making champagne in France!

The decade of 1980s and the early part of 1990s were an era of big changes in the field of biotechnology and bioengineering and also at the U–M. Advances in cellular and molecular biology are revolutionizing various industries and creating new ones. But many engineering faculty members still felt that no new initiatives were necessary and many preferred that the introduction of some of the new technical vocabulary into our regular chemical engineering courses would suffice. There were also some turnovers in personnel in the department. Professor Jerry Schultz stepped down as the chair of the department and went on a sabbatical leave to NSF. He eventually left the U–M and went to the University of Pittsburgh to start up their new Center of Biotechnology and Bioengineering. Professor Bernhard Palsson from Professor Edwin Lightfoot’s laboratory in Wisconsin was recruited to our department.

We decided that our traditional research and training in biotechnology and bioengineering need to be revamped. I concluded that my own fermentation research would be better off if performed in the newly created, state-funded Michigan Biotechnology Institute (MBI) located in Lansing, Michigan. I negotiated with Dr. Gregory Zeikus, president of MBI to have a split appointment at MBI and the University of Michigan in order to help the generation of new initiatives in biotechnology across the State of Michigan. I underestimated the degree of deep-seated

mistrust and interstate rivalry among various organizations and was not successful in this endeavor. At the U–M, the general consensus is that we should focus more on biomedical-related research. Professor Palsson and I were successful in obtaining some funds from the dean's office and NSF to establish a cell-culture facility in the college. We initiated a cross-disciplinary effort in biotechnology and bioengineering through writing an Engineering Research Center proposal with many faculty members across the campus. Even though it was not funded, it created an appealing atmosphere for multi-disciplinary efforts on campus. The results were truly remarkable. Professor Palsson established a very visible and permanent focus in cellular bioengineering and tissue engineering in the Chemical Engineering Department. With several medical school professors, he even established a small local biotechnology company called Aastrom Biosciences, based on his bone-marrow culture research. Theoretically, our department should benefit from this technology transfer effort. At the same time, Professor Charles Cain was recruited to head the Bioengineering Program after an extensive review of the program and eventually guided this program into a newly established Department of Biomedical Engineering through a Whitaker Foundation special grant.

The Chemical Engineering Department has changed significantly in the past decade. Even though Professor Bernhard Palsson chose to leave the U–M and join the newly created Department of Bioengineering at the University of California in San Diego, we have also recruited several outstanding and energetic young faculty members in the field of biotechnology and bioengineering. Professor Jennifer Linderman joined our department in 1989. Her research interests center around understanding the biochemical and biophysical mechanisms used by cells to sense, respond to, and interact with their surroundings. An ability to understand and manipulate these mechanisms is thus crucial to many areas of modern biotechnology, including cell and tissue engineering. In particular, her group focuses on understanding and manipulating receptor-mediated cell phenomena, for receptor/ligand binding is the initiating event in many cellular responses. Currently, they focus on two areas:

1. A theoretical and experimental investigation into the mechanisms of signal transduction in human neutrophils, with the aim of quantitatively manipulating cell behavior (a collaboration with Dr. G. Omann, Departments of Surgery and Biological Chemistry).
2. A primarily theoretical investigation into the determinants of ligand efficacy, i.e. the differential abilities of ligands binding to the same receptor type on the same cell type to elicit responses.

Professor Mark Burns joined our department in 1990. His research interests center on the development of new separation, purification, and analysis systems to be used in the field of biotechnology. A new frontier in bioprocess technology

is the coupling of micromachining and microfabrication with current macroscale reaction and separation analysis systems. Just as the computer industry was revolutionized by silicon micromachining, bioelectronics and microanalysis have the potential to be transformed by advances in semiconductor and new material processing techniques. Mark has been working with collaborators in the EECS and Human Genetics Departments in this front. Professor David Mooney joined our department with a split appointment at the School of Dentistry in 1995. His primary research is focused around two related areas of cell and tissue engineering effort that were initiated in our department by Professors Schultz and Palsson. The first area is studying how the gene expression of mammalian cells is regulated by signals present in their microenvironment (e.g., adhesion molecules and mechanical forces). This understanding is utilized in the second experimental area to design and synthesize polymers that interact with cells in a desired manner to produce a specific cellular function. These polymers are utilized to transplant cells and engineer new tissues. This approach to engineer new tissues may ultimately provide alternatives to whole organ or tissue transplantation, and the work is motivated by the tremendous shortage of tissues available for transplantation. They are currently working to engineer a replacement tissue for women who have undergone mastectomies, and liver and muscle tissue. Specific thesis topics range from the design and synthesis of biodegradable polymers to the investigation of the intracellular signaling mechanisms that dictate the cellular response to defined external stimuli.

Other chemical engineering faculty members have also gradually moved into the field of biotechnology and bioengineering. Professor Stacy Bike has been investigating various non-specific interactions between cells and various solid surfaces. Professor Ronald Larson, an expert rheologist recruited from Bell Labs has been interested in the macromolecular motion of DNA and other biomolecules. Professor H. Scott Fogler has had several research projects in bioremediation. Therefore, I venture to suggest that most if not all our chemical engineering faculty members will eventually be doing some direct or indirect bio-related research in the near future. We are now trying to establish a new identity in the College of Engineering by establishing a new graduate research and training program in intelligent biomanufacturing. Manufacturing has been targeted as a core competence for the U–M College of Engineering. Intelligent biomanufacturing is defined as the use of the fundamental understanding of biological and biochemical systems, transport processes, and reaction and separation systems for the intelligent design and production of molecules, cells, tissues, and/or devices. Specifically, we will train our current and future students to design and engineer intelligently:

- Biomolecules to manipulate cells, tissues, and/or organisms.
- Cells and tissues to produce biomolecules or perform some other biological functions.

- Assays or sensors to quantify molecules, cells, and/or tissues.
- Processes to produce all of the above.

An integrated curriculum in intelligent biomanufacturing will be formed with many chemical engineering faculty members as the core. The program includes:

- Establishing a central training facility of process biotechnology and developing several new hands-on courses.
- Identifying an intelligent biomanufacturing track within chemical engineering and related disciplines.
- Strengthening and coordinating the bioengineering activities within and across campus.

One unique feature is that all graduate students in this program will spend some time to do practical training in a non-academic environment and will have an industrial/non-academic mentor in addition to their regular academic advisor. The combination of industrial mentors and faculty from across the university will provide the students with a unique educational experience at the U–M. Thus, biotechnology and bioengineering have a bright future and will be an integral component of the Department of Chemical Engineering. We look forward with much anticipation to the next 100 years!”

NATURAL GAS ENGINEERING

by M. Rasin Tek, Jack R. Elenbaas, and Thomas L. Gould†

Overview

Early years. In 1913, A.H. White had written *Technical Gas and Fuel Analysis*, published by McGraw-Hill, with a second edition in 1920. Although the book was devoted largely to gas produced from coal, it was the harbinger of a strong and traditional interest of the department in gas research for years to come.

During the early 1920s, the Natural Gasoline Association of America (NGAA) and, later, the Natural Gasoline Supply Men’s Association (NGSMA) played an important role in the development of research related to gas at Michigan. Following the footsteps of A.H. White, two men from the Phillips Petroleum Company in Bartlesville, Oklahoma—George Oberfell (vice-president) and R.C. Alden (director of research)—authored *Natural Gasoline, Testing, Manufacturing, and Properties*, published by W.B. Conkey in Chicago in 1924. At the time, this book was the first guide, manual, and standard reference for the oil and gas industries. In 1930, G.G. Brown and Mott Souders‡ revised the book in cooperation with Oberfell and

† As chemical engineers at Michigan, Jack Elenbaas received his B.S.E. in 1944 and his M.S.E. in 1947, and Thomas Gould his Ph.D. in 1972. A biography of Rasin Tek appears on page 536. Reference has also been made to *An Interview with Donald L. Katz*, by Enid Galler, Voice Treasures, Ann Arbor, 1987.

‡ Mott Souders later became associate director of research at Shell Development in Emeryville, California.

Alden. A further revision of this landmark book was by G.G. Brown and G.G. Oberfell, *Natural Gasoline and the Volatile Hydrocarbons*, published by the NGAA in Tulsa in 1948.

Collaboration by G.G. Brown with Oberfell and Alden resulted in a series of publications by the NGAA that provided basic data, fundamentals, and correlations for both the natural gas and natural gasoline industries. Through a succession of outstanding graduate students at the U–M, this work continued under the leadership of Brown and D.L. Katz.



M. Rasin Tek, with an award recognizing his chairmanship of the U–M ROTC Committee, 1986.

G.G. Brown had also been working with the Natural Gas Processors' Association (NGPA) on fuels before Katz joined him as a student in the 1920s. Thus, Katz also became acquainted with the NGPA, attending their meetings while he was at Phillips Petroleum in the early 1930s, and also solving some of their problems—including two summers working on the field testing of wells. It was during this period that Katz, working with Karl Hachmuth, started his pioneering research into phase behavior. This work led to the celebrated Katz and Hachmuth papers on equilibrium constants.† These publications are still in practical use and of much

† For example: Katz, D.L., and K.H. Hachmuth, "Vaporization equilibrium constants in a crude oil/natural gas system," *Ind. Eng. Chem.*, **29**, 1076 (1937).

interest today, remarkably some 65 years later.

Our close relationship with the Phillips Petroleum Company is worth emphasizing. Many of our faculty and students (graduate and undergraduate) worked for Phillips as employees, researchers, managers, executives, and consultants. We recall at least G.G. Brown, D.L. Katz, Gordon Green, Ted Legatski, Harold Legatski, Brymer Williams, Walter Podbielniak, Fred Poettmann, Donald Stinson, Kent Thomas, and Rasin Tek.

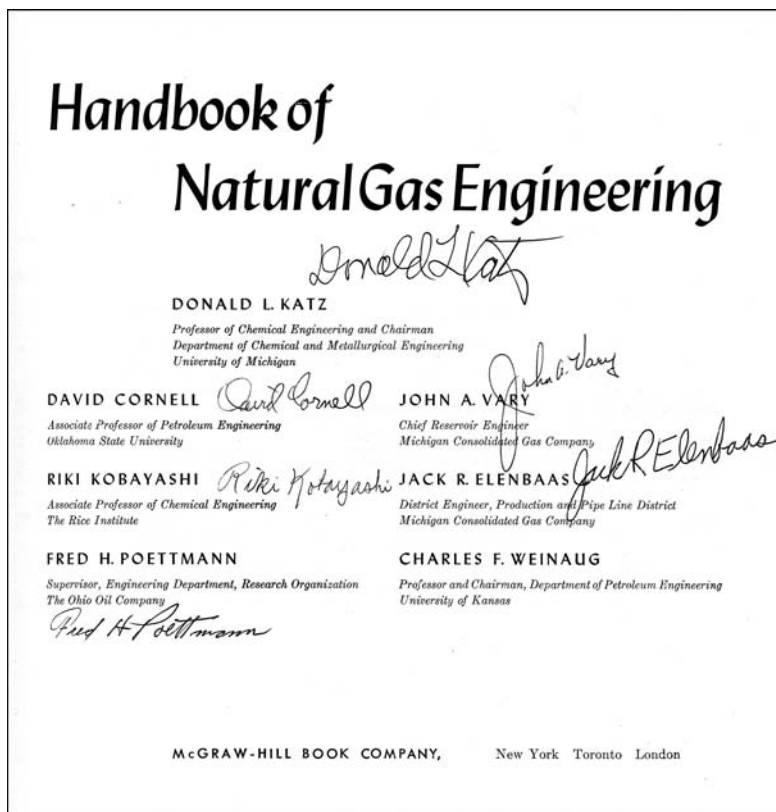

Title page of “Handbook of Natural Gas Engineering,” 1959.

After returning from the Phillips Petroleum Company in 1936, Donald Katz spearheaded research into natural gas and closely related areas, particularly evidenced by the large number of doctoral students working with him in the 1940s and 1950s. In 1986, the then Gas Processors Association established the Donald L. Katz Award, to recognize contributions to research related to light hydrocarbons.

The Katz years. What might be termed the “Katz years” followed shortly after G.G. Brown became dean of the College of Engineering, when Katz was

appointed chairman of the Chemical and Metallurgical Engineering Department. With a professional and dedicated faculty, the traditions started by A.H. White and G.G. Brown matured into a “golden age” of chemical engineering. For excellence, it has been said that character must precede intellect. The faculty during the Katz years had both. We had Cedomir Sliepcevic, Joe Martin, and Dave Ragone in thermodynamics; Stuart Churchill, Brymer Williams, and J. Louis York on the chemical side; Maury Sinnott, Lawrence Van Vlack, Edward Hucke, and Richard Flinn on the metallurgical side; and some—such as Edwin Young and Lloyd Brownell—were active on both sides. These, and others, have left their marks.

Under the Katz leadership much of the teaching, research, and consulting touched on natural gas. We recall the Sliepcevic and Churchill studies on LNG, Williams, R.R. White and York on unit operations, Wilkes and Carnahan on numerical methods, and Joe Martin on equations of state. During the early Katz years a large number of technical papers were published in phase behavior, thermodynamic properties, fluid mechanics, and heat transfer.



Jack R. Elenbaas.

On 30 June 1955 a research conference on flow of natural gases from reservoirs was held at the U–M. One of the papers presented, “Input flow test method determination of well performance,” was written by J.A. Vary, J.R. Elenbaas, and H.J. Withrow, the first two of whom were soon to become coauthors of Katz’s landmark book, *Handbook of Natural Gas Engineering*. This research conference marked the beginning of an annual summer short course given at the U–M for

many years by Katz, joined later by M. Rasin Tek, who was a very significant addition to the team. It was during Katz's 1956/1957 sabbatical leave that Tek was interviewed (successfully!) by Brymer Williams for a faculty position in the department. Rasin and his wife, Gretchen, made a courtesy call at the large Hill Street home of G.G. Brown and his wife, where they received a warm welcome.

After he joined the department, Tek played a prominent role in natural gas engineering teaching and research, both in collaboration with Katz and also independently. Studies during the Katz/Tek collaboration included reservoir engineering, aquifer storage, non-D'Arcy flow, movement of water in contact with gas, threshold pressures in caprocks, two-phase flow, simulation of storage-reservoir behavior, diffusion and mixing in porous media, and verification of inventory and assurance of deliverability in underground storage.



Riki Kobayashi.

Handbook of Natural Gas Engineering. During his half-time sabbatical leave for the 1956/1957 academic year, when Brymer Williams was acting chairman of the department, Donald Katz completed much of the book that secured his international reputation: *Handbook of Natural Gas Engineering*, McGraw-Hill, New York, 1959. In his memoirs, Prof. Katz recalled that he started writing the book in 1953 with five of his former students (David Cornell, Riki Kobayashi, Fred Poettmann, Jack Elenbaas, and Charles Weinaug) and a close associate at the gas company (John Vary). It was a very significant publication—about 800 pages in an $8\frac{1}{2} \times 11$ -inch format. In its early years, the price of the book was \$37.50, and it was still selling some 28 years after publication. It was translated into Russian in 1965.

Later years. For many years, Katz and Tek had taught an engineering summer conference short course on natural gas engineering. In about the early 1980s this course was split into two. The first continued to be taught by Katz in Ann Arbor, assisted by R.C. MacDonald and J.R. Elenbaas; this course was given through 1987 and the course notes served as the basis for a book by Donald L. Katz and Robert L. Lee (see below); the course continued to be taught in Grand Rapids by R.L. Lee, J.R. Elenbaas, D.J. Elenbaas, and R.C. MacDonald (all U–M graduates) and C.G. Nelson. The second, involving Rasin Tek, had a more international flavor, and was taught in venues such as Hanover, Paris, Sydney, Calgary, Houston, Salt Lake City, and Ankara, Turkey. After Katz’s retirement, natural gas research was largely directed by Rasin Tek and essentially faded away a few years after his retirement in 1986. There are no more lights at 10 PM in the East Engineering Building, and no more Saturday lunches at the downtown Round Table. In fact, no more East Engineering, no more Round Table.

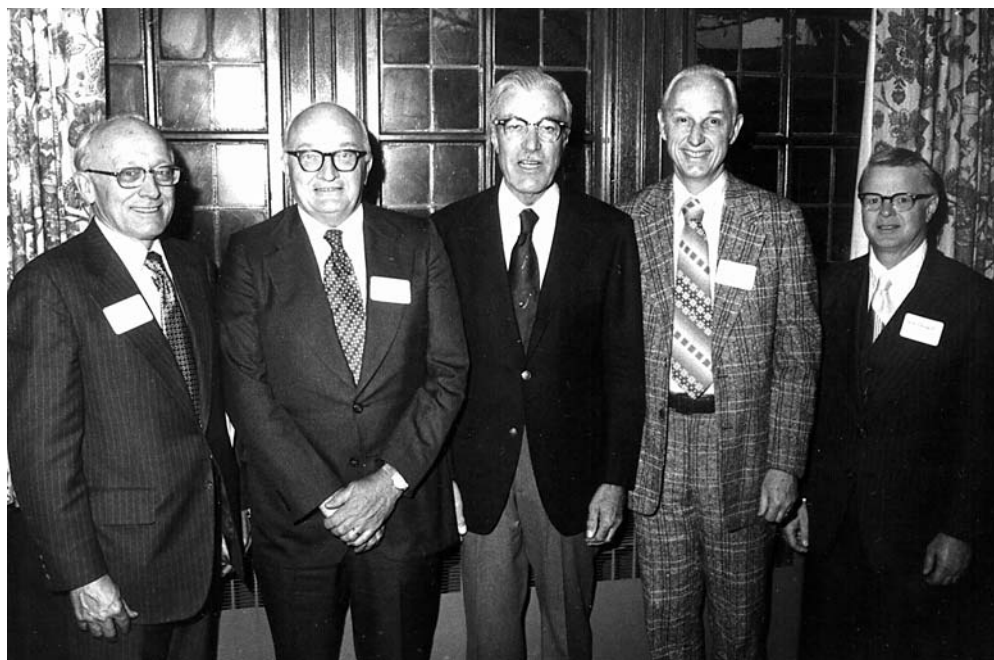

U–M Information Services

Five of the seven co-authors of “Handbook of Natural Gas Engineering.” John A. Vary, Fred H. Poettmann, Donald L. Katz, Jack R. Elenbaas, and David Cornell, on the occasion of the dinner party at the Michigan League, 15 April 1977, honoring Donald Katz on his retirement from the University of Michigan.

However, the real legacy of natural gas teaching and research in the department is in the large number of our students who have obtained responsible positions in the natural gas industry.

Some idea of the wide variety of natural gas research, and the many students involved in it, can be obtained from the lists of related major publications and dissertations, which start on page 347.

Numerical methods. A noteworthy consequence of the collaboration by Katz, Tek, Wilkes, and others has been the application of numerical methods to various aspects of petroleum-producing operations beyond natural gas. Several of our students have made major contributions to the modeling of phase behavior, fluid flow in porous media, and production systems.

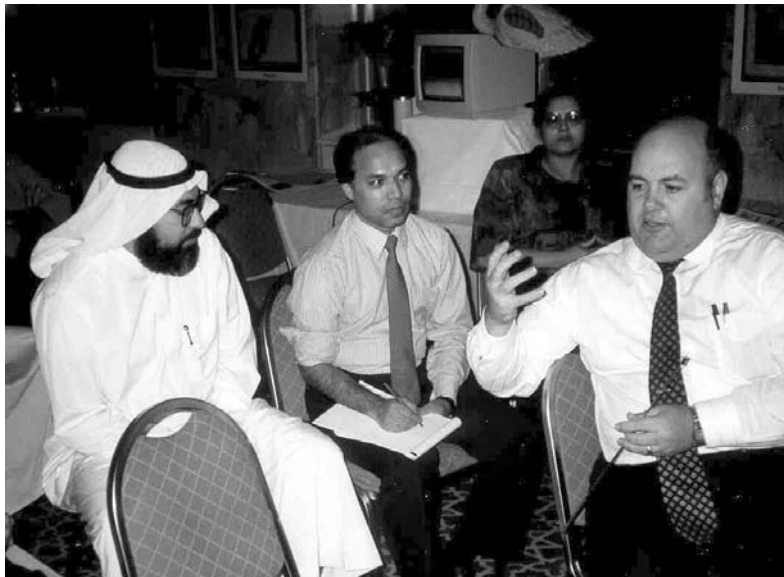

Thomas L. Gould (R), from a seminar he gave in Kuwait in 1991, just after the Gulf War. He was discussing methods to determine lost production and reservoir damage, as a result of the well fires, with representatives of the Kuwait Oil Company.

Keith Coats has been recognized as the father of numerical simulation of oil and gas reservoirs. After earning his doctorate at the U-M, he joined the faculty at the University of Texas and developed the first public black-oil reservoir simulation model. Keith later formed a company around this technology, named Intercomp Resource Development and Engineering. He then went on to develop the first equation-of-state-based compositional reservoir simulation model and the first thermal model for simulating steam and combustion floods. Keith was joined in 1972 by Tom Gould, who extended the models to include wells, gathering systems, and pipelines. Keith Coats continues to collaborate with Kent Thomas at Phillips Petroleum to advance the science of numerical modeling.

Thermodynamics of hydrocarbon systems. Over the years many students have worked with Katz and Tek on phase behavior, fluid properties, and thermodynamic topics in petroleum systems. In 1975, graduate student Dave Bergman, working with Katz and Tek, published an AGA monograph based on work done at U–M, entitled *Retrograde Condensation in Natural Gas Pipelines*, which has become a classic in its field.

Table 27 Society of Petroleum Engineers Awards to U–M Alumni

<i>Recognition</i>	<i>Name</i>	<i>Year</i>
<i>DeGolyer Distinguished Service Medal</i>	Fred H. Poettmann	1990
<i>Distinguished Service Award</i>	Marvin L. Katz	1982
<i>Cedric K. Ferguson Medal</i>	Thomas L. Gould	1975
<i>John Franklin Carll Award</i>	Donald L. Katz	1964
	Fred H. Poettmann	1971
<i>Lester C. Uren Award</i>	Marshall B. Standing	1965
	Fred H. Poettmann	1966
	Keith H. Coats	1984
	Thomas C. Boberg	1991
<i>Honorary Members†</i>	Marshall B. Standing	1991
	Marvin L. Katz	1993
<i>Anthony F. Lucas Gold Medal</i>	Marshall B. Standing	1977
	Donald L. Katz	1979
	Keith H. Coats	1989
	George W. Govier	1990
	Abbas Firoozabadi	2002
<i>Reservoir Engineering Award</i>	L. Kent Thomas	1993
	Abbas Firoozabadi	2000
<i>Distinguished Member</i>	Keith H. Coats	
	Jack R. Elenbaas	
	Thomas L. Gould	
	Marvin L. Katz	
	Lowell R. Smith	
	Marshall B. Standing	
	M. Rasin Tek	
	L. Kent Thomas	

†Taken from an SPE table listing those living as of 1 October 2000.

Abbas Firoozabadi did post doctoral work with Katz in 1977 and went on to

become highly recognized by the petroleum industry for his work on thermodynamics of hydrocarbon reservoirs and production, and multiphase flow in fractured permeable media. Abbas has taught at the graduate level at Stanford University, the University of Texas at Austin, Imperial College, London, and Yale University. He credits Katz with laying the foundations of his future career in petroleum science. Abbas has created a research group, Reservoir Engineering Research Institute, to expand petroleum technology further.

Recognition by the Society of Petroleum Engineers. Marshall Standing, Donald Katz, Keith Coats, George Govier, and Abbas Firoozabadi have been recognized by the Society of Petroleum Engineers (SPE) for their technical contributions over the years with Lucas Gold Medals. Established in 1936 as the society's major technical award, the Lucas Medal recognizes distinguished achievement in improving the technique and practice of finding and producing petroleum. A collection of U-M faculty and students has also been recognized by SPE for their contributions over the years, as indicated in Table 27.

Books

The following books, relating to gas research and technology, were authored or coauthored by our faculty.

- *Technical Gas and Fuel Analysis*, A.H. White, McGraw-Hill, New York, 1913, with a second edition in 1920.
- *Natural Gasoline and the Volatile Hydrocarbons*, G.G. Brown and G.G. Oberfell, Natural Gasoline Association of America, Tulsa, 1948.
- *Handbook of Natural Gas Engineering*, D.L. Katz, D. Cornell, R. Kobayashi, F.H. Poettmann, J.A. Vary, J.R. Elenbaas, and C.F. Weinaug, McGraw-Hill, New York, 1959.
- *The Underground Storage of Natural Gas—Complete Design and Operational Procedures with Significant Case Histories*, M.R. Tek, Gulf Publishing Company, Houston, 1987.
- *Underground Storage of Natural Gas: Theory and Practice*, NATO Advanced Study Institute, Ankara, Turkey, 1988, M.R. Tek (editor). Kluwer Academic Publishers, Dordrecht, Holland, 1989.
- *Natural Gas Engineering, Production, and Storage*, D.L. Katz and R.L. Lee, McGraw-Hill, New York, 1990.
- *Natural Gas Underground Storage: Inventory and Deliverability*, Rasin Tek, PennWell Publishing Co., 1996.



Three Michigan Ph.D.s: Harold G. Donnelly (Ph.D. 1952, sometime chairman of ChE at Wayne State University), Robert R. White (Ph.D. 1941), and Richard Lee Huntingdon (Ph.D. 1934, sometime chairman of ChE at the University of Oklahoma). Taken at our 50th anniversary in 1948.

American Gas Association Monographs

A significant part of our natural gas research was sponsored by the American Gas Association. Although they are primarily research reports, the following five monographs were published in hard covers and received wide dissemination.

Movement of Underground Water in Contact with Natural Gas, D.L. Katz, M.R. Tek, K.H. Coats, M.L. Katz, S.C. Jones, and M.C. Miller, 1963.

New Concepts in the Underground Storage of Natural Gas, M.R. Tek and J.O. Wilkes, with D.L. Katz, D.A. Saville, B.D. Bhalla, and L.G. Sherman, 1966.

Threshold Pressure in Gas Storage, Maher A. Ibrahim, M. Rasin Tek, and Donald L. Katz, 1970.

Retrograde Condensation in Natural Gas Pipelines, D.F. Bergman, M.R. Tek, and D.L. Katz, 1975.

Inventory, Migration, and Deliverability in Underground Storage, M.R. Tek, E.O. Udegbunam, R.L. Lee, R.W. Logan, and J.S. Ahluwalia, 1986.

Doctoral Dissertations†

The following doctoral dissertations relate to natural-gas research performed in our department. It has sometimes been difficult to decide if a particular dissertation falls into the category of natural gas engineering, or if its central thrust is in a related area such as thermodynamics, in which case it would not be included in the list. We apologize for any unintentional omissions. The initials of the supervisor follow the name of the student and the date of publication.

Fred Kurata, 1941, DLK. *Critical properties of volatile hydrocarbon mixtures.*

Marshall B. Standing, 1941, DLK. *Vapor/liquid equilibria of natural gas/crude oil systems.*

Willard I. Wilcox, 1941, DLK. *Natural-gas hydrates.*

Charles F. Weinaug, 1942, DLK. *The surface tension of methane/propane mixtures.*

Leo B. Bicher, Jr., 1942, DLK. *The viscosity of light hydrocarbon mixtures under pressure.*

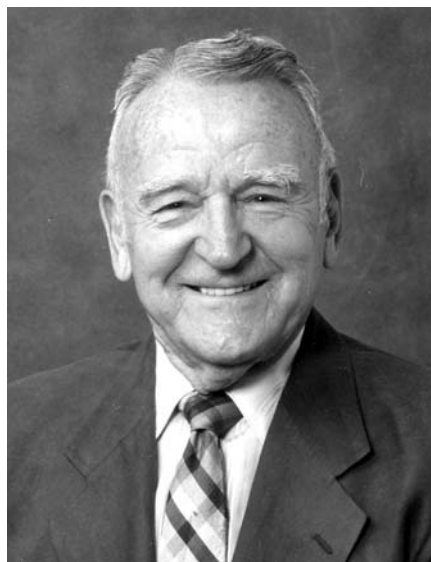

John J. McKetta, Jr., a U-M student from 1942–1945, followed by an illustrious career at the University of Texas at Austin. He was AIChE president in 1962. Photo taken 1999.

† To avoid several pages of distracting upper-case letters, dissertation titles generally have only the first letter of the first word capitalized.

John J. McKetta, Jr., 1946, DLK. *Vapor/liquid/liquid equilibrium in hydrocarbon/water systems. The methane/n-butane/water systems.*

Fred H. Poettmann, 1946, DLK. *The phase behavior of carbon dioxide in paraffin.*

Michael J. Rzasa, 1948, DLK. *Phase equilibria of methane/Kensol 16 at temperatures to 250° F.*

Harry J. Aroyan, 1950, DLK. *Vapor/liquid equilibria in the hydrogen/n-butane system at temperatures from 75° F to -200° F and pressures from 300 to 8,000 pounds per square inch.*

Riki Kobayashi, 1951, DLK. *Vapor/liquid equilibria in binary hydrocarbon-water systems.*

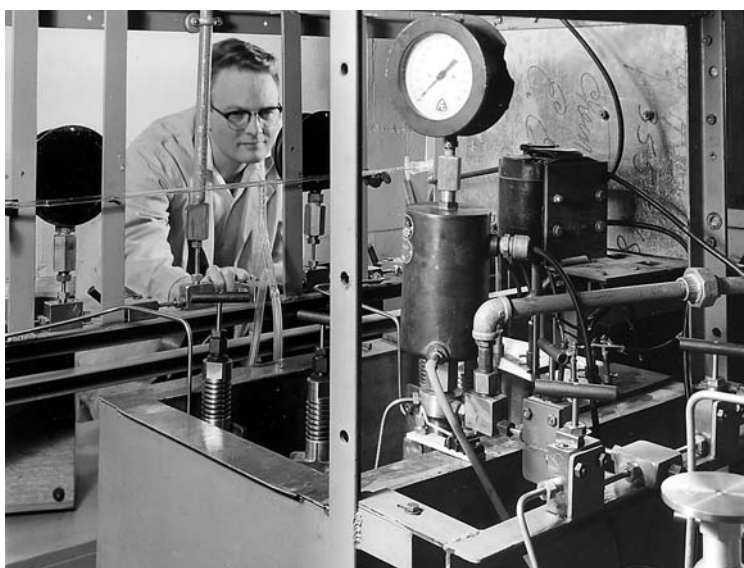

Howard Silver (Ph.D. 1961, with Brymer Williams) with equipment for determination of vapor/liquid equilibria in cryogenic hydrogen/methane systems.

David Cornell, 1952, DLK. *Flow of gases through consolidated porous media.*

Harold G. Donnelly, 1952, DLK. *Two-phase and three-phase equilibria in the system carbon dioxide/methane.*

Alvin L. Benham, 1956, DLK. *Vapor/liquid equilibria of hydrogen/light hydrocarbon systems.*

Donald L. Stinson, 1957, GBW. *Miscibility of natural gas and crude oil.*

Harry Cosway, 1958, DLK. *Low-temperature vapor/liquid equilibria in ternary and quaternary systems containing hydrogen, nitrogen, methane, and ethane.*

Keith H. Coats, 1959, MRT. *Prediction of gas-storage reservoir behavior.*

Richard C. Faulkner, 1959, DLK. *Experimental determination of the thermodynamic properties of gases at low temperature and high pressures.*

Marvin L. Katz, 1961, MRT. *Fluid flow and heat transfer in stratified systems.*

Howard F. Silver, 1961, GBW. *Vapor/liquid equilibrium ratios in hydrogen and hydrocarbon mixtures.*

Millard L. Jones, 1961, DLK. *Thermodynamic properties of methane and nitrogen at low temperatures and high pressures.*

Robert L. Gorrington, 1962, DLK. *Multiphase flow of immiscible fluids in porous media.*

Russell L. Nielsen, 1963, MRT. *On the flow of two immiscible incompressible liquids in porous media.*

James R. Street, 1963, MRT. *A study of vertical gas-liquid slug flow.*



U-M Chem/Met graduate booklet, Dec. 1963

Alan J. Brainard (Ph.D. 1965, with Brymer Williams) working on the vapor-liquid equilibrium for the hydrogen-benzene-cyclohexane-n-hexane system.

Alan J. Brainard, 1965, GBW. *A study of the vapor/liquid equilibrium for the quaternary system hydrogen/benzene.cyclohexane.normal hexane.*

Max W. Legatski, 1966, DLK. *Dispersion coefficients for gases flowing in consolidated porous media.*

L. Kent Thomas, 1967, DLK. *Threshold-pressure phenomena in porous media.*

Thomas L. Gould, 1972, MRT/DLK. *Vertical two-phase flow in oil and gas wells.*

Vijender Verma, 1974, DLK/JHH. *Gas hydrates from liquid hydrocarbon-water systems.*

David F. Bergman, 1976, DLK. *Predicting the phase behavior of natural gas in pipelines.*

Gerald D. Holder, 1976, JHH. *Multiphase equilibria in the methane, ethane, propane, water hydrate-forming systems.*

Khashayar Aminian, 1982, MRT/James L. Wilson. *The synergetic study of Silurian/Niagaran pinnacle reef belt around the Michigan basin for exploration and production of oil and gas.*

Emmanuel O. Udegbunam, 1983, MRT. *Migration of natural gas from storage reservoirs.*

Robert L.-H. Lee, 1986, MRT. *Deliverability of natural gas.*

Jolly S. Ahluwalia, 1988, JOW. *Wellbore-storage effects in the transient flow-testing of gas wells.*

Elizabeth C. Batesole, 1993, JOW. *Temperature and pressure distributions of natural gas in aquifer storage reservoirs.*



Elizabeth Batesole (Ph.D. 1993) at the projector, talking to her fluid mechanics research group about the Joule-Thomson effect in underground gas storage, ca. 1988. At the left in the front row are Nitin Anturkar and Rosemarie Wesson Williams; in the back row (L to R) are Jim Wilkes, Tasos Papanastasiou, Georgios Georgiou, and Joe Greene.

PHOTOGRAPHS OF OTHER RESEARCH ACTIVITIES



Graphic Arts Corporation of Ohio

Larry Warzel (Ph.D. 1955, with Brymer Williams), using water to absorb carbon dioxide and other gases from an air stream in the investigation of tray efficiencies for a bubble-cap column. This project was the first in the country to be sponsored by the AIChE, and was located on the second floor of East Engineering, outside Room 2219.

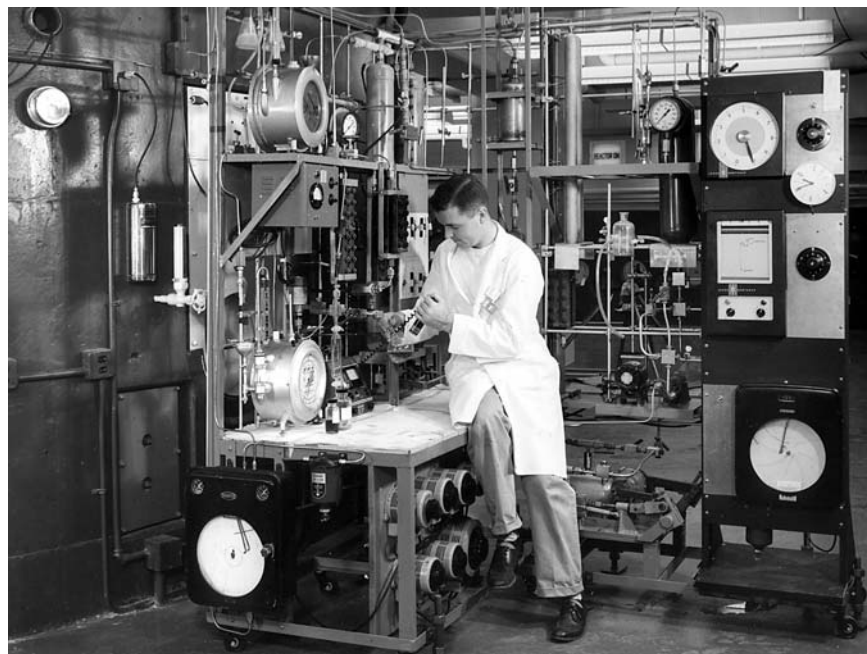

U-M Chem/Met graduate booklet, Nov 1957

George Miley (Ph.D. 1958 with Joe Martin on the effect of radiation on chemical reactions) checks the radioactivity of a liquid that has just been subjected to neutron and gamma radiation from the Ford nuclear reactor.



U-M Chem/Met graduate booklet, Nov. 1961

Richard Schwing (Ph.D. in 1963 with Joe Martin), with a constant-volume calorimeter and shielding, used for measuring the high pressure thermodynamic properties of chloro- and fluoro-methanes.



U-M Chem/Met graduate booklet, Dec. 1963

James Skinner, measuring diffusivities in porous media.



U-M Chem/Met graduate booklet, Dec. 1963

Dean L. Smith, (Ph.D. 1965 with Robert Kadlec) working on research leading to his dissertation "Mass and energy transfer between a confined plasma jet and a gaseous coolant."

RESEARCH AREAS—2002

As of 2002, the department has consolidated its research into three major areas. The associated activity of each faculty member is shown below.

1. Life Sciences and Biotechnology

Mark Burns. *Microfabricated chemical analysis.* Biochemical separations, field-enhanced separations, micro-fabricated analysis systems, DNA genotyping and sequencing.

Erdogan Gulari. *DNA and peptide synthesis.* Micro-array design and engineering.

Jennifer Linderman. *Receptor dynamics.* Mathematical modeling of cellular biology, biotechnology, applied mathematics, immunology.

David Mooney. *Tissue engineering.* Biomaterials, cell adhesion, tissue engineering.

Henry Wang. *Bioprocess engineering.* Pharmaceutical engineering, bioprocessing for sustainable development, biochemical engineering.

2. Energy and the Environment

Scott Fogler. *Flow and reactions in porous media.* Enhanced oil recovery, laser-enhanced etching; catalyzed dissolution, oil-pipeline plugging and remediation.

Erdogan Gulari. *Reactions at interfaces.* Catalysts for fuel cells, catalysts for clean air, biochips, thin films.

Phillip Savage. *Kinetics and mechanisms for environmental systems.* Chemical reactions in high-temperature and supercritical water.

Johannes Schwank. *Catalysts, fuel cells, and fuel conversion.* Heterogeneous catalysis, thin films, chemical sensors, fuel cells.

Levi Thompson. *Catalysts, reactor, and fuel cells.* Nitride/carbide catalysts, fuel processing, micro-fuel cells and micro-reactors.

Ralph Yang. *Adsorption, reactions, hydrogen storage.* New adsorbents, environmental catalysis, gas/carbon reactions, carbon nanotubes.

3. Complex Fluids and Nanostructured Materials

Stacy Bike. *Experimental complex-fluids research.* Colloid and interfacial science, fluid mechanics, dispersion rheology, cell/surface interactions.

Sharon Glotzer. *Computational nanoscience and soft materials.* Assembly of nanoscale systems; molecular motion in polymers, colloids, and complex fluids; nanostructured and nano-filled materials.

Ronald Larson. *Theoretical, computational, and experimental complex fluids.* Complex fluids, polymers, fluid mechanics, surfactants, biomolecules, transport theory, rheology, instabilities, constitutive theory.

Michael Solomon. *Experimental complex-fluids research.* Polymeric, colloidal, and multiphase fluids.

Robert Ziff. *Theoretical and computational complex fluids and transport.* Aggregation kinetics, catalysis, thermodynamics, statistical mechanics, mathematical methods, computer simulation, diffusion in polymers.

Chapter 14

PHOTOGRAPHIC INTERLUDE 2: DEPARTMENT AND CAMPUS SCENES

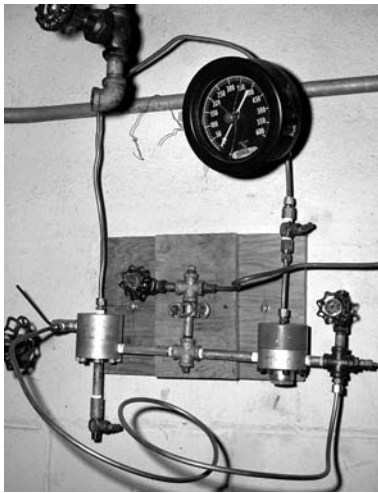

James Wilkes

Our research equipment has always been built to the highest aesthetic standards.



James Wilkes

Brice Carnahan and John Dealy, hosts of one of their famous "Bert & Harry" parties at their 525 Haven apartment, December 1962.



James Wilkes

Terry Martin, Murray Player, Brymer Williams, Mary Sinnott, and Dale Briggs, at Brice Carnahan's Ph.D. party, May 1965.

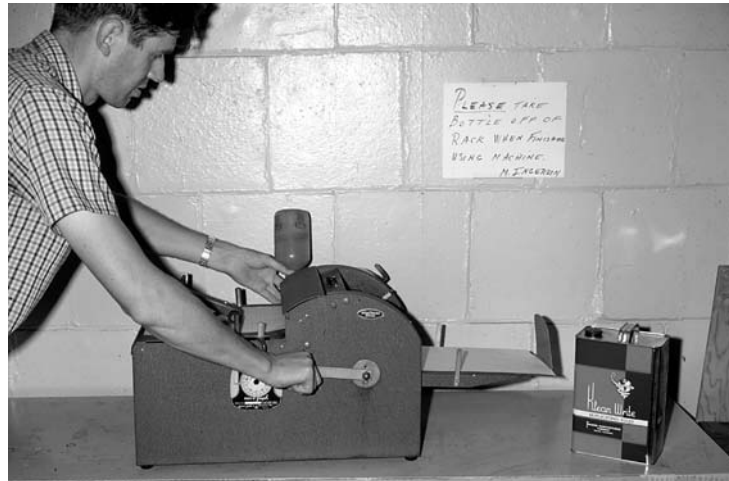

Until about 1970, all copies of handouts, examinations, etc., were made on this "ditto" machine. A master was made by writing on paper backed by a second sheet impregnated with a blue dye. Contact of the master on a rotating drum with a methanol-soaked pad gradually dissolved the dye and about 200 copies could be made on paper fed through the machine. East Engineering Building, 1967.



James Wilkes

Karl Weissenberg (L), who gave a memorable seminar on polymer rheology in April 1966. (With George Jackey, U.S. representative for the Weissenberg rheogoniometer.)



James Wilkes

Necessity is the mother of invention. The direct approach to solving a problem was always our philosophy in East Engineering.



James Wilkes

Prof. Wilkes invites students to “stop by” his 3030 East Engineering office. The traffic lights had been appropriated by “friends” from the Highway Department on the first floor of East Engineering. The Ann Arbor police eventually called Prof. Wilkes, asking if he had a set of traffic lights in his office, to which he replied: “Just a moment, I’ll have a look. Yes, as a matter of fact, I do have a set of traffic lights in my office.” Late 1960s.



James Wilkes

A familiar ritual for the newly arriving graduate students from overseas. Mary Ann Wilkes contemplates unpacking in North Campus student family housing, Sept. 1960.



James Wilkes

*Former Administration Building (now the LS&A Building),
September 1955.*



James Wilkes

U-M Dentistry Building, fall 1956.

The people in the group at the bottom of the next page are: (back row) Ralph and Frances Yang, Mike Solomon, Demi Hammer, Barry Wolf, Dieter Schweiss, Probjot Singh, and Christine Garman; (front row) Jim and Mary Ann Wilkes with “Dinah,” Piyarat (“Ann”) Wattana, Manish Chopra, and Chris Bennett.



North Campus from the south, in 1958. The buildings to the left of the road (Beal Avenue), from the middle foreground to the dark trees, are: U-M Printing Services, the Cooley Laboratory (with the Phoenix Memorial Laboratory to the left), the Lay Auto Laboratory, and the G.G. Brown Building.



A picnic at a ChE faculty member's house, 1998. (See page 361.)

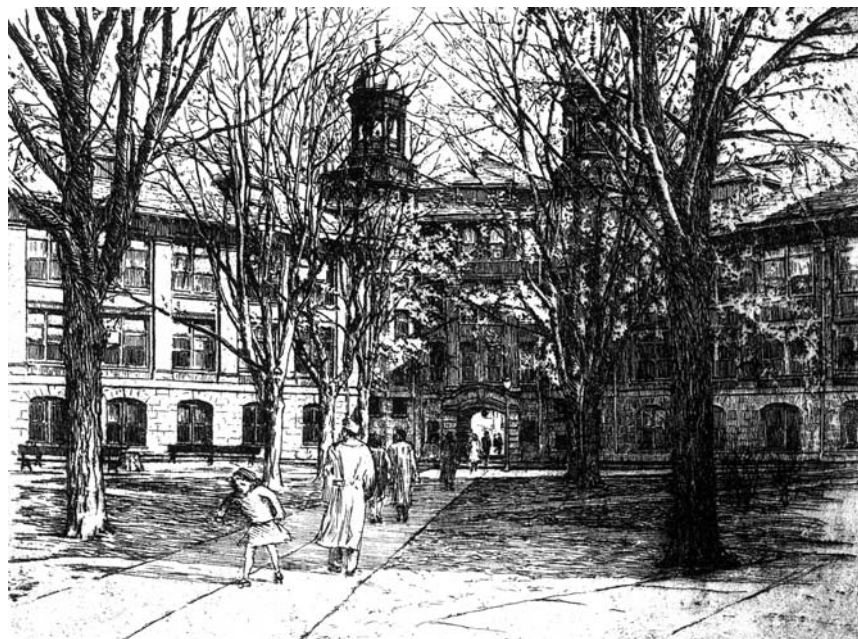

University of Michigan Press

The Engineering Quadrangle (West Engineering Building with the “Diag” and the “Engin. Arch.” From the 1953 “Encyclopedic Survey of the University of Michigan.”).



Three of the older faculty (Briggs, Carnahan, Wilkes) and three of the younger (Ziff, Kravaris, Linderman), annual fall graduate picnic, Gallup Park, 1989.

Chapter 15

STUDENTS AND STUDENT ACTIVITIES

THE U–M AICHE STUDENT CHAPTER

by Katie Konopka, B.S.E. 2000[†]

THE University of Michigan's student chapter of the American Institute of Chemical Engineers received its charter in 1922 from the national organization after students and faculty petitioned for affiliation. In the more than seventy years that AIChE has been on campus the organization has grown to more than 100 active members composed of sophomores, juniors, and seniors, and an alumni base in the thousands. Members are recruited throughout the year, but most members join in the beginning of the fall term.

U of M's AIChE chapter has gained a reputation for excellence, represented by its string of Outstanding Student Chapter Awards. Especially interesting to note is that this excellence has been supported by a number of people as the advising position at the U–M has been rotated among faculty for decades. Student presidents have come and gone as well, serving their terms of leadership while taking classes and planning their futures. Students run all facets of the organization; the positions of president, external vice-president, internal vice-president, secretary, treasurer, social chair, alumni-relations chair, and publicity chair are elected annually from the general AIChE membership. Additionally, two students are elected to serve as co-chairs responsible for producing the campus organization's weekly newsletter, *The Column*.

Industry has supported the organization since its founding and in recent history, Michigan's AIChE chapter has been supported by some of the chemical industry's giants, led by Dow Chemical of Midland. Corporations have seen the job the group of student leaders has done in preparing their future employees and have made sure that AIChE's activities are well funded. Alumnus Dr. Clifton S. Goddin has also been very generous in meeting any emergency financial needs.

[†] Kathrina J. "Katie" Konopka graduated from Wayne Memorial High School and began her collegiate career at Western Michigan University in the fall of 1996, transferring in spring 1998 to the U–M, from which she graduated in December 2000. She served as AIChE student-chapter president from May 2000–January 2001, and AIChE student-chapter publicity chair from September 1999–May 2000. She was awarded the G. Brymer Williams Scholarship in April 1999 and the Helen B. Gibson Scholarship from the Chemical Engineering Department in May of 2000 (see page 436 for her photograph).

The student chapter at the U-M is committed to meeting the needs of its members by providing both career and educational services. In recent years, AIChE's most popular event has been meeting both of these targets. The weekly luncheons hosted by AIChE introduce the membership to the industrial world while giving a square meal. Every week a new speaker from different companies gives a presentation about his or her particular job and industry. Additionally, answering how their degree in chemical engineering helps them in their job is a key item in every talk. On the occasions when industry representatives are not presenting, graduate student panels and discussions involving alternative career paths for chemical engineers are the topics.

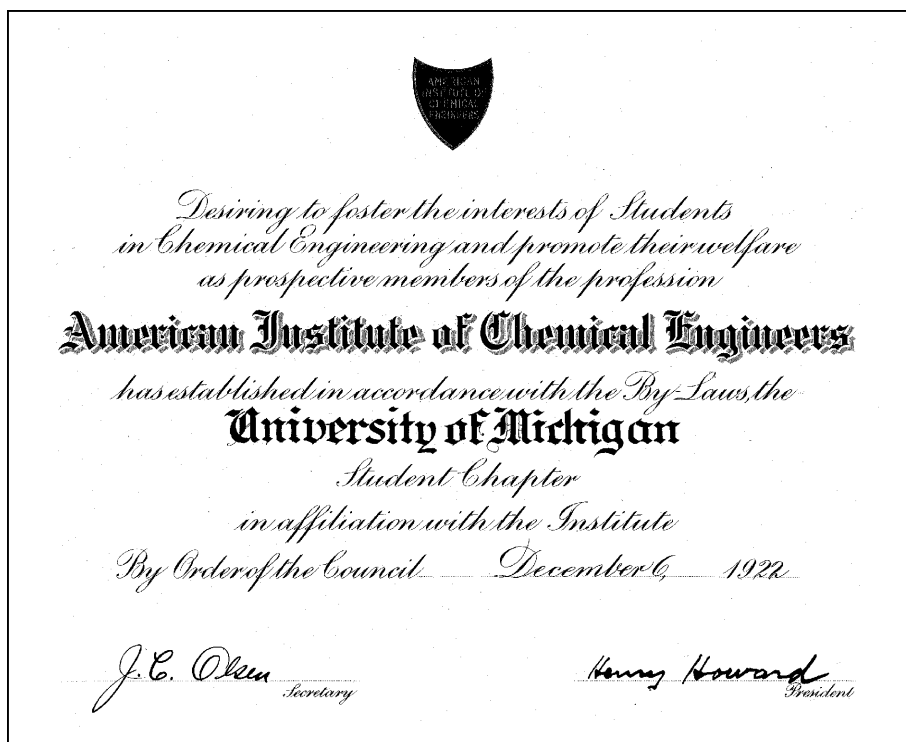

AIChE Michigan student chapter charter.

During the fall term, AIChE occasionally hosts pre-interview sessions, which give hiring companies the opportunity to tell students about their organization, what they expect of their interns and new hires, and the types of course work that they recommend for a job in their company. AIChE encourages companies at these sessions to allow résumés to be presented and student members gladly accept the chance to “showcase” themselves.

Michigan's student chapter takes part in many college-wide functions throughout the year that promote engineering and our discipline in particular. To recruit

more students into chemical engineering at the U–M, AIChE participates in Welcome Day and Tech Day, in which the college introduces engineering disciplines to incoming engineering students and high-school students.



Sharon Glotzer

U–M officers and organizers of the Ann Arbor AIChE 2002 Regional North Central Student Conference, held in Ann Arbor. Back row: Decker Ringo, Eyad Abu-Isa, Michelle Bates, Eric Sirota, Hannah Murray (conference chair), J.R. McNair, Rebecca Domzal, Alex Thibonnier; front row: Yiping Lim, Tim Lao, Jessica Motyl (chapter president), Alice Chou, Melissa Salloum. Inset: faculty advisor Sharon Glotzer.

To accommodate the social needs of our members, AIChE also holds monthly “happy hours” and intramural sports teams. Twice during the academic year, AIChE meets its traditional campus rivals Omega Chi Epsilon, the chemical engineering honor society, in two sporting events. Also, in 1998 AIChE started an annual charity golf outing in which we invite various companies to send representatives to play a scramble golf tournament with the students. Most recently AIChE has donated to the Detroit based charity Save our Sons and Daughters. During the 1999–2000 school year, in order to establish a closer link with our graduates,

AIChE's alumni committee started a mentorship program, in which a sophomore student is paired with junior or senior student with similar interests. We are hoping that in the years to come more students will take part in the mentorship program and through the network created, provide an easy pipeline to keep in touch with former members.



Sharon Glotzer

AIChE Regional Conference 2002. Students from visiting universities present their solution for the ChemE Innovation Challenge to judges. Teams were given a bag of supplies and challenged to find a method for separating oil from water. Solutions were judged on the basis of efficiency, cost-effectiveness, and creativity. North Campus Media Union.

Staying active in the larger national organization is a goal of Michigan's AIChE chapter. Our student chapter sends students to the AIChE regional and national conferences in order to keep Michigan's chapter up to date with ongoing activities. In the past few years, Michigan's student chapter has been giving a presentation on industrial relations at the national conference.

Following previous active involvement on the national scene, the U-M AIChE chapter hosted the 2002 Regional North Central Student Conference on the 7th and 8th of February, 2002. The conference attracted over 175 students from ten schools in six states in a two-day event that included field trips to local industrial plants, an industry fair, a paper competition, an etiquette luncheon, and the ChemE Car Competition, a tradition that began at Michigan in 1999. The conference also

included a new event, the ChemE Innovation Contest, in which teams comprised of students from all schools competed to separate oil from water. The conference chair was Hannah B. Murray, a U–M senior in chemical engineering. As indicated by the accompanying three photographs, great fun was had by all!



Sharon Glotzer

AIChE Regional Conference 2002. Another team presents their solution for the ChemE Innovation Challenge.

THE CHEMICAL ENGINEERING GRADUATES SOCIETY—CHEGS

CATALYSIS. Fluid dynamics. Molecular simulations. Reactor design. Cellular engineering. Tissue engineering. Microfabrication. American. Indian. Chinese. Japanese. Korean. Swedish. South African. These are just a few of the descriptions that can be used to describe the wide array of interests and backgrounds held by the graduate students in our department. This diversity is what makes our department so successful, as long as these interests are shared. Diverse scientific interests permit the exchange of novel ideas from one field to another, resulting in more creative solutions to difficult problems. Diverse backgrounds allow us to understand better the cultures and histories of those with whom we live and work. Unfortunately, diversity also has the potential to isolate students from one another, causing them to associate with only those people in their own research group or only those who have similar backgrounds.



ChEGS officers, 2001. Tesfu Solomon (UMEC representative), Ali Mohraz (vice-president), Kathryn W. Riddle (Web master), Sean P. Holleran (president), and Christopher J. Brinkerhoff (treasurer).



James Wilkes

*Doctoral students and ChEGS officers
Chris Lorenz and Peter Woolf, 2001.*

In 1993, two chemical engineering graduate students, Kevin Seibert and Tim Werner, founded the Chemical Engineering Graduates Society, or ChEGS, to handle this “diversity” issue. The original intent of ChEGS was to bring graduate

students and faculty together in any way possible in an effort to foster a sense of community throughout the department.

Membership in ChEGS is open to all graduate students in the department, with no fees charged and no applications to complete! Funding is provided by the University of Michigan Engineering Council (UMEC), and the Michigan Student Assembly (MSA). Because free food is always popular with graduate students, the first activities sponsored by ChEGS were study breaks, where students and faculty could socialize over an afternoon bagel. Soon, ChEGS expanded to selling bratwurst and sponsoring a departmental softball team. Currently ChEGS has expanded its list of social activities to include cultural study breaks, Friday-night happy hours, holiday parties, and other sporting teams such as soccer and rowing.

Table 28 ChEGS Officers, 1993–2002

<i>Year</i>	<i>Officers</i>
1993	Kevin Seibert, Tim Werner
1994	Kevin Seibert, Tim Werner
1995	Kevin Seibert, Tim Werner, David Putnam, Lonnie Shea
1996	Kevin Seibert, Yakeitha Fields, Timothy Werner, Tahmid Mizan
1997	Jim Cunningham, Barry Wolf, Joel Padin, Dave Maurer
1998	Naoko Akiya, Jim Waldecker, Kalyan Handique, Barry Wolf, Manish Chopra, Paul Suding
1999	Kurt Seefeldt, Molly Smith, Fnu Paritosh, Chris Lorenz, Cattaleeya Pattamaprom, Michael Keinath, Stacy Pyett
2000	Peter Woolf, Molly Smith, Gina Wilson, Ali Mohraz
2001	Sean P. Holleran, Ali Mohraz, Christopher J. Brinkerhoff, Tesfu Solomon, Kathryn W. Riddle
2002	Sean P. Holleran, Ali Mohraz, Elaine Chan, Prasanna Thwar, Tami Kinzer

In response to student demand, ChEGS also sponsors an annual speaker. The students nominate speakers and then vote to make a final selection. In past years we have successfully convinced the likes of Edwin Lightfoot (1997) and Octave Levenspiel (1998) to speak to our department.

In recent years, ChEGS has also begun to address professional issues such as the quality of graduate-student education and work conditions in the department. In 1998, ChEGS performed a department-wide survey of the graduate students attitudes toward their advisors, work conditions, coursework, and the morale of the department in general. Although the review was for the most part positive, the survey did reveal specific problems, such as overcrowding, that were brought to

the attention of the faculty. To help new students adjust to life in Ann Arbor and the department, ChEGS also sponsors an incoming graduate student mentorship program, in which each new student is paired with a current graduate student to help explain how life is in the department.



Jim Cunningham (ChEGS officer), Edwin N. Lightfoot (University of Wisconsin) after his 1997 seminar, and graduate student Nick Hutson.



James Wilkes

Octave Levenspiel of Oregon State University, after his 25 March 1999 seminar, “Making Friends with Reactors,” with ChEGS president Kurt Seefeldt.

A tradition revived. For many years, some of the graduate students and faculty presented a “skit” at the annual graduate student/faculty picnic. For some reason—perhaps excessive devotion to research or a lack of student and faculty

candidates who deserved lampooning (just joking, on both counts), these skits were discontinued in the late 1970s. However, as one of the activities of ChEGS, the tradition was revived at an informal dinner held in March 2000 at the Ziff's home for prospective graduate students. James R. Waldecker (Ph.D. 2000), narrates in his own inimitable style:

“On March 11, 2000, the prospective students at the open house weekend unexpectedly found themselves as contestants in a “game show,” courtesy of the graduate students! Entitled “Who wants to be a Michigan chemical engineering graduate student?,” each prospective student was introduced before the department and given an opportunity to go for the “grand prize” of admission to graduate school. The sketch was modeled after the popular TV game show, “Who wants to be a millionaire?,” with Jim Waldecker playing the role of Regis Philbin.



James Wilkes

Jim Waldecker and Gina Wilson, March 2000.

Jane Doe of Generic University (Gina Wilson) answered the Fastest Fingers question, correctly ranking Kathie Lee Gifford at 1 bar, Hawaiian Punch at 2,000 bar, an ideal gas at 2,000 bar and an ideal gas at 3,000 bar in order of increasing fugacity. She was then given the opportunity to answer fifteen questions to gain admission to the department. Professor Fogler's doctoral dissertation, *The Lowdown on Kinetics*, was a guaranteed prize after five correct answers. A rotary-drum filter and a goat were guaranteed after ten correct answers. There were three

lifelines: ask the audience, consult Perry's *Handbook*, and phone a friend.

Some of the questions were tough, for example:

- “The Reynolds Number was named after whom?” (Reynolds).
- “Which of the following . . . boils at 100 °C?” (water).
- “A heat exchanger exchanges what?” (heat).
- “In – out + generation – consumption equals what?” (accumulation, not intoxication, levitation, or devastation).

Jane correctly answered the opening questions while winning a used Kimwipe, a full sharps bucket of glass waste, a trip to the Burns Clean Room and Spa, and a copy of *Essence* magazine lying around in Professor Schwank's laboratory. For Professor Fogler's dissertation, she was asked what the white structure in front of the Dow Building (see page 201) was capable of doing, with the following choices:

- (a) Shielding North Campus from nuclear assault.
- (b) Blasting off.
- (c) Bringing ESPN College GameDay to every lab.
- (d) Rusting.

Jane answered (d), and moved on! For some leftover samples, she knew that Phil Savage was not once a member of the Poison rock group. A bottle of Calvin Klein's “Compression for Women” was the reward for knowing that Swagelok was neither chewable, banned by the Brady Bill, nor fun for the whole family, but, rather, a type of metal fitting. Professor Wilkes's “Keep Britain Dry” apron was given for knowing that catalyst porosity is evaluated by nitrogen adsorption isotherms (not aftertaste), and an actual Dow Building trash bucket was given away for knowing that the Navier-Stokes equations were applicable for incompressible fluids, not those that do nothing for enhancing the taste of poultry.

On the tenth question, Jane was forced to use a lifeline! The audience was polled concerning whether pinane, beta-camphor, methacrolein, or citral was most volatile. Responding 25%, 25%, 25.1% and 24.9% for the four compounds respectively, Jane wisely sided with the audience and won the rotary-drum filter and goat. Another lifeline was used on the eleventh question. Jane used Perry's *Handbook* to identify the drag coefficient of air bubbles in tap water at 100 °C and $Re = 100$. The next question asked “What is the seventh word of the first line of the second column on page 9–34 in Perry's *Handbook*?” Having already used the Perry's *Handbook* lifeline, this was a little tricky. Nevertheless, Jane knew that word was “the,” having dutifully memorized Perry's like every chemical engineering student should. The structure in front of the Dow Building was given away for knowing an appropriate reference to chemical engineering in a Marky Mark and the Funky Bunch song from 1991. On the second-to-last question, Professor Gulari's Hawaiian home was won for knowing the atomic number of polonium. Jane's husband urged her to stop with the home, but she continued anyway for the grand prize.

Unfortunately, she was stumped about the first step in solving a reactor design problem. Professor Fogler was called as Jane used her last lifeline. Professor Savage ran in from the kitchen to report that Professor Fogler’s line was busy, and that therefore, the lifeline was wasted. Jane came through anyway, remembering that the mole balance was the first step and winning the prize of admission.”

All were encouraged to attend next year’s open house, when the graduate students will be presenting another parody of life in the department.



James Wilkes

*Front: Molly Smith, Sean Holleran, Stacy Pyett;
back: Peter Chang, Katherine Riddle, Tami Kinzer.
March 2001.*

A tradition continued. On March 17, 2001 the six students in the above photograph performed another skit: “Whose Line is it Anyway?,” based on the popular ABC television program. The program is a gameshow-style competition between four comedians who are assigned points based on their performance in a number of different improvisational games. In the interest of not neglecting any faculty member worthy of light-hearted ridicule, the games and parts for this skit were planned ahead of time. Here is the script.

1. Introductions

In the interest of preserving inter-departmental relations, we’d like to begin with this disclaimer: “This skit and the events depicted herein are entirely fictitious. Any resemblance to actual persons, places, or occurrences is purely coincidental and should be . . .” What? Wait a minute. Who wrote this?! This is completely wrong! You guys, the whole purpose was to make fun of people! Okay, I’m sorry. Let’s just forget the disclaimer. We’ll just leave you with this piece

of advice from Bobby Slayton: “If you can’t laugh at yourself, make fun of other people.”

2. *The News*

Tami will be the news anchor of a live TV broadcast. Kat is a field reporter on location, and Sean and Pete will play the various people being interviewed.

- (a) Weather: G.G. Brown computer lab declared miracle of nature—sauna in winter, freezing in summer.

An undergrad student (played by Pete)

“It’s like *soooo* cool that we’re witnessing a miracle of nature! I always knew that lab was special. Ever since I saw a vision of Elvis in the printer cartridge.”

Daryl Sell [*Office manager*] (Sean)

“Someone has taken the office staple remover, please return it.”

- (b) Poison gas leak discovered at beach house in Hawaii, evacuations of the Gulari family and at least ten raccoons are underway.

- (c) Sports: ChEGS softball team ends season 0–22.

Team manager Chris Lorenz (Pete)

“Yeah, but we out-drunk every one of those teams in the bar afterwards.”

Avid fan Gina Wilson (Sean)

“Yeah, but how many other teams had fans with crème brûlée in their picnic dinners?”

Team member Sachin Shanbhag (Pete)

“Which way do you run again? I bet we would have killed them at cricket.”

- (d) Larson attacked by large inflatable structure.
 (e) Fashion: assistant professors everywhere showing up in running shorts! Students scandalized!

Horror-stricken MIT student (Sean)

“All that pale pasty-white leg flesh! Oh, the horror!”

Trend-setter Mike Solomon (Pete)

“I didn’t mean to hurt anybody. Ellen and I just like to run. Really!”

- (f) Ziff buried under avalanche of old papers—Savage called in for emergency “office organization” briefing.

(Stacy) Five hundred points to Pete for being an Elvis fan. (Molly) A thousand points to Professor Solomon for his fashion sense.

3. *Party Quirks*

Kat player is the host of a party. The other three enter as guests one at a time. In this game, each guest has an unusual quirk that Kat has to guess—in this case, they’ll each be playing a professor of chemical engineering.

- (a) *Gulari, limping* (played by Pete), talks about wind-surfing, beach house, then wanders off to nap in the corner.
- (b) *Fogler* (Sean), talks about his Web page, new teaching strategies and gets everyone to pose with his book.
- (c) *Larson, in sling* (Tami), talks about his time at Bell labs, and explains why chip dip is a complex fluid.

(Stacy) A hundred points to Tami for best scientific usage of chip dip. (Molly) Three hundred points to Kat for correctly identifying all three guests.



Ali Mohraz

Graduate student and faculty softball teams, Burns Park, 23 June 2001.

4. *World's Worst . . .*

Standing in a line, players step forward to give examples of things that might be said by the world's worst person to share a lab with.

"Ummmm . . . this fell off of that machine over there yesterday. Sorry, I hope it wasn't anything important."

"You don't mind if I play this Whitesnake CD do you? Great. Thanks."

"Dude, you've got to see this Web site I found. I can't believe they got an elephant to do that!"

"Group meetings? Early Monday morning would be best for me."

"Hi. I'm Molly Smith."

"What's that you're reading? Email? Ooooooh . . . from a girl? Is it your *girlfriend*? Look, she called you 'honey-bear!' Your annoying lab-mate? What's she talking about?"

“Did you touch my stapler? Because I don’t deal well with people touching my stapler.”

“So if it was radioactive it would be glowing green, right?”

(Stacy) Minus two thousand to Kat for making fun of Molly. (Molly) Plus a thousand to Kat for Whitesnake reference.

5. *And the winner is . . . “We have a surprise winner! Despite not actually participating in the game, the winner is Mike Solomon with 1,000 points!”*

The first annual ChE faculty/student softball game took place on 23 June 2001. A spirited battle was waged between the crafty and experienced veterans of the faculty and the ambitious and eager upstarts among the graduate students. Department chair Ron Larson, devoted manager of the educators’ squad, assembled a varied crew for his team, ranging from recent additions Mike Solomon and Rob Lionberger to established stalwarts Phil Savage and Mark Burns, and to near-septuagenarian Jim Wilkes. The faculty opened strongly, only to have the students rally to tie the game at 3–3 following the third inning. After that, the youth pulled away to stretch their advantage to 11–3. Only some late heroics by Savage and a grand slam by Burns were able to make the final score a respectable 11–8. Talk of a rematch was instantly underway and rumor has it that the faculty have already begun practicing for next year’s contest.

Softball reviews by Jim Waldecker. Doctoral student Jim Waldecker (Ph.D. 2000) provided regular and entertaining reviews of ChEGS softball games—34 of them, from 8 May 1998 until 5 July 2000. We reproduce here his “swan song” review. The Website <http://www.engin.umich.edu/soc/chegs/softball.html> gives reviews of all the games.

July 5, 2000—Green ChEGS Almost Win a Game

Ann Arbor, MI (AP)—No, that headline doesn’t imply that the Green ChEGS have switched to cricket. Wednesday night, the Green ChEGS took a game of softball and made it competitive.

Unfortunately, the first game was of the Lakers-vs-Clippers quality that Green ChEGS has patented, with some statistical variation. For efficiency, we here at the AP have developed a “form-letter” style for reporting these types of games. Details pertinent to last night’s first game are in parentheses:

The (Dawgs) jumped on top of Green ChEGS with (5) runs in the first inning. Green ChEGS managed to hold the (Dawgs) to a few low-scoring innings before getting pounced on in the fourth inning. In the meantime, Green ChEGS got a runner on third in the (third) inning and scored by the (third). Green ChEGS (did) score another run, and lost by (1) order of magnitude.

Of course, this account does leave out certain important details. For example, the score was 20 to 2, but nobody really needs to know that. Each thrown strike

caused the umpire to pass a kidney stone. However, some said he just sounded like he was passing one, and that grown men often make strange noises at the sight of well-thrown softballs. Mike Keinath made a kick save to keep a rolling ball in play, but needs to work on using his instep. At the plate, Jim managed an RBI in his return from a “broken hand” (which did plenty for his figure), and Dylan went 2 for 2 with a run scored. Matt, a Jim recruit, also went 2 for 2 with a run scored.

In game two, the Golden Turkeys almost went where no team has been since Adam’s Tree Service in June of ’99: defeat at the hands of Green ChEGS!!! Jeff led off the game, advancing to second by punishing first baseman, pitchers, and all carbon-based life forms in his path. Jeff remained on second after Jim’s single. Since the third baseman’s life insurance policy did not specifically cover “maulings by Missourians,” Jeff was awarded a trip to home plate. The rally continued with an ill-fated attempt by Chris Brown to get an inside-the-park home run (a.k.a. triple and a 7–5–2 putout). At the end of the first inning, the score was 4–3 Turkeys.

The self-proclaimed “Gobble-Gobble Defense” was stubborn. The only Green ChEGS run in the next three innings was scored by Jeff, who had now turned the base paths into a bad Hong Kong film, kicking balls out of gloves and following the contrived plot of the softball game to show off his martial-arts prowess. After four innings, the score was 5–4, and Green ChEGS became hungry for turkey.

The Turkeys scored two in the fifth, and Green ChEGS answered with two in the sixth. Chris Brown and Nao scored on a triple by Dylan. Dylan, going 4 for 5 with 3 RBIs and a run scored, was later voted the Courvoisier Player-of-the-Night. The Turkeys added on two runs in the sixth, and the Green ChEGS entered the top of the seventh with a 10–6 deficit. Going down 1–2–3, the Green ChEGS’s golden opportunity slipped away.

The Green ChEGS thank Stacy and her brother Pat, Ali, and the newest Mrs. Burnett (Kate) for coming out and finally getting their money’s worth. The next games are rain-delay makeups scheduled for 7:15 and 8:30 PM at Mitchell Field next Wednesday night

. . . but this reporter won’t be there, nor to any more games. At 2:20 PM this Sunday, I’m on a TWA flight to Houston with no return trip. Work begins at ExxonMobil Chemical on Monday. And no, I’m not giving anyone the Fax number to send me the scorecard!!!

I appreciate all the wonderful comments everyone has made to me over the past three seasons. Some have even been about this softball column. It’s been a privilege to write for all of you, staff, faculty, students, Gina’s husband’s parents, Stacy’s mom, and Mrs. Fogler alike! I’ll miss all of you!

Jim (Waldecker)

THE SOCIETY OF WOMEN ENGINEERSby **Kristina Wheaton, B.S.E. 2000**[†]

THE Society of Women Engineers (SWE) is an organization dedicated to the advancement of women in engineering fields through professional development opportunities, academic guidance, and a general support system. In addition, SWE works to expand the image of engineering as a profession that improves the quality of life. SWE is dedicated to promoting diversity in the community, serving as a center of information on women in engineering, and encouraging women engineers to attain high levels of educational and professional achievement. In order to accomplish these goals, SWE works to introduce young women to engineering and science fields through community involvement and mentorship programs with students. SWE also serves the entire engineering community by offering professional networking opportunities, community service and outreach opportunities, as well as working to promote diversity through panel discussions and deans' forums.

Some of the most significant programs sponsored by the society are the annual Career Fair; the Summer Engineering Exploration Program, a week-long summer career-discovery program on campus to introduce pre-college women to engineering and the University of Michigan; pre-interviews, informal company information sessions prior to formal interviews; mentorship programs with students and professionals; elementary- and high-school visits; scholarships; and community service and social events.

Each year, representatives from the society attend the National Student and Professional Convention, held in a different city each year. At the 1999 convention held in Phoenix, Arizona, the University of Michigan SWE chapter proudly took home the title of "Best National Student Section," an award based on the programs and accomplishments of the student sections of all universities. This recognition was truly an honor, as nearly 300 student chapters from around the country competed for this award.

SWE is open to all students (including men) interested in supporting and promoting women and engineering in technical sciences. SWE provides opportunities for professional and personal growth, while creating an atmosphere in which friendships can develop. SWE at the University of Michigan has undergone many changes over the years, broadening the chapter into an organization that has opportunities for everyone and one that has its finger on the pulse of the campus and community.

[†] Kristina Wheaton is a chemical engineering student from Rochester Hills, Michigan. Her most significant contribution to the college is her involvement in the Society of Women Engineers, where she has served as treasurer and president. Other involvements include active participation in Tau Beta Pi, Epeians, and volunteering with Services for Students with Disabilities. She was also the recipient of the Clifton S. Goddin Prize for 2000. After completing her undergraduate degree in December 2000, Kristina continued at the U-M in the Program in Manufacturing, to earn a master's in manufacturing degree one year later. Her photograph appears on page 396.

LIFE IN THE 1930s

by F. Drake Parker, B.S.E. 1936, M.S. 1937†

CHEMICAL engineering at Ann Arbor is now understandably different from what it was in the 1930s. But certain principles might well be permanent features of the profession. High on the list—in my opinion—is the concept that ChE knows no boundaries. The ChE works with the global fundamentals of earth, water, and air to make this world a better place for all of its citizens. I am happy and proud to be able to say that in a lifetime career in engineering and construction of process plants in all parts of the world I have made a modest contribution to the well-being of mankind. And I am grateful to the U–M and the ChE Department for providing me with the education and skills to make this possible. Student life at the U–M during the period February 1932 to April 1938 was dominated by the Great Depression that followed the stock-market crash of October 1929. In 1932 unemployment was in the 20–30% range, the Dow was around 200, banks were folding, soup kitchens and breadlines kept out-of-work people from starving, and the Volstead prohibition act was in force so *there was no beer!*



Paul Jaronski

Drake Parker, May 1998

Also, there were no federal student-loan programs and very few grants and scholarships. Many students worked part-time to meet their expenses. For some this called for a balancing act between academic excellence and economic survival. But it provided valuable preparation for the real world that they would find after graduation. It also provided a platform for meeting students and town people with diverse cultural, intellectual, and economic backgrounds—in my opinion one of the major purposes of a university education. Costs were low. A hamburger was a dime, a Coke was a nickel, a dance date with a co-ed at the Michigan Union might cost two dollars. Tuition was—as I recall—about \$75 per semester. Roosevelt took office as president in 1933. Prohibition was repealed, 3.2% beer appeared on the scene to help kill some of the pain. However, despite the formation of myriad agencies and programs, economic conditions did not significantly improve until the late 1930s, when government and industry started serious preparations for World War II.

† This article of 15 June 1998 was accompanied by a note from Drake Parker to Jim Wilkes: “Thanks for your kind note of 10 May 1998 and kudos for your masterful MC gig which did so much to make the Centennial a rousing success and an event never to be forgotten by this ‘old grad.’ The afterglow of the celebration warmed up some of my memory retrieval processes and resulted in the enclosed notes touching on this student’s view of ChE and campus life at the U of M in the 1930s. I hope you will find some of it interesting.”



Basement of the high-bay area in the East Engineering evaporator laboratory during the student days of Drake Parker. “A” is a drip tank for measuring condensate, and there is a vacuum pump in the left center.

The Faculty

A.H. White was department chair. He also taught a course, *Industrial Chemistry*, and occasionally acted as a tour guide for undergraduate plant visits. One of these was to the River Rouge plant of the Ford Motor Company, which at that time included a vertically integrated plant starting with coal and iron ore and ending up with finished cast-iron engine blocks. For many students this was a grimy, gritty first-time exposure to the real world of Michigan’s automobile industry. On the subject of soap-making, Professor White had a phrase that perhaps best stereotyped the role of the ChE at that time, He referred to the engineer at Procter & Gamble who conceived the idea of making Ivory soap float by adding air to the mix in the kettle as “. . . a brilliant engineer with a great invention that made a lot of money *but only for the company.*”

The four faculty names that stand out in my memory are Badger, Baker, Brier, and Brown—the four Bs. There were of course other noteworthy characters.

Badger was viewed by first-year students as a tyrant whose caustic comments such as “. . . you’re not engineers, you’d be better off running a hardware store” could make many a wannabe engineer shake and shiver. But he was quite right in insisting on rational approaches to problems and practical solutions. The ChE lab, which took up a large part of the East Engineering Building, was filled with process equipment, much of which Badger obtained from industrial sources such as the Swenson Evaporator Company. He indoctrinated students with his view that the ChE’s job was to translate the chemistry of beakers and test tubes into commercial and profitable process plants—a view which could be summed up as “Hardware is the Name of the Game.” So impressed was I by this view that shortly after I left Ann Arbor in 1938 I arranged for the Fluor Corporation to contribute a small-scale cooling tower to the department, which was erected on the roof of the East Engineering Building.

A high point of Badger’s class and lab courses came each semester in the “48-hour evaporator salt run.” Students were divided into teams with rotating assignments for the dissolving of salt, evaporation of water from the brine, recovery of reconstituted salt, making heat and material balances for each part and the aggregate of the operation. Equipment used included the aforesaid Swenson evaporator assembly plus mixers, centrifuges, drums, scales, etc. It seemed like a lot of hard work at the time, but it was fun—unless there were operational miscues or mistakes in calculations. In such cases Badger would get really steamed up and students would get royally blistered.

Another Badger teaching gimmick was the “pump in a basket” project. Early in their introduction to the ChE lab students operated a small reciprocating pump. At their next session, they would find the pump completely disassembled (by a lab assistant such as myself) and the parts dumped in a bushel basket. Their assignment was to reassemble the pump and have it back in working order ASAP. During my stints as an assistant in the ChE lab I usually kept one small pump part in my pocket until they discovered the need for it to make the pump run. This made the “pump in a basket” project considerably more challenging.

Baker was a kind and understanding mentor, whose engineering research projects were primarily in electrochemistry, whereas my interests were more in engineering of process plants for the organic chemical industry. He handled a number of research projects for the automotive industry, mostly involving plating of bumpers, grills and trim with nickel, chromium, etc. But he was well grounded in all aspects of ChE and was most helpful in the selection of courses in my junior and senior years and in the work for my master’s degree.

The name Brier is—in my mind—a virtual synonym for soy bean. In the period 1932 to 1938 it seemed that one end (or about one fourth) of the ChE lab

was filled with soy beans, solvent drums, and solvent-extraction equipment with which Brier and his students were experimenting to find the best ways to reduce soy beans to meal and oil. Unfortunately, my interests at that time were not in the Farm Chemurgic, few if any of my classes were taught by Prof. Brier, and I was not privy to the day-to-day successes and failures of his large and worthy soy-bean projects—or how they all worked out in the end. I do recall that the program of the State of Illinois to make automobile license plates from soy-bean based plastic was a laughable disaster because dogs loved the smell and taste of the plates and ate them at every opportunity.

Brown is recalled as the most worldly member of the four Bs, perhaps because his research in hydrocarbon science and teachings in petroleum technology were closely related to my interests in distillation and organic chemical-process plants. He managed a large number of consulting and engineering research projects that called for student help from time to time. Naturally, students who participated in such projects were happy to endorse his honorary title of “Great God Brown.” I particularly recall projects that involved road-testing automobiles for fuel economy and performance with various gasoline blends; students working on these projects spent afternoons driving around in new luxury vehicles and being paid for it. Life was good!

Other names that keep coming up through the golden haze are:

- J.H. Rushton. His was a universe of vats and drums and tanks and mixers and crystallizers and scrapers . . . he was “Lord of the Mixmaster World.”
- Prof. Running, a classical gentleman of the Old School who taught differential equations.
- Assoc. Prof. Donald W. McCready, whose work for Kimberly Clark on paper making processes and machinery led to the now famous Kleenex brand of tissues.
- Prof. Moses Gomberg of the Chemistry Department, whose lecture series on organic chemistry I found fascinating.

The ChE Lab

As above noted, during my student days major emphasis was placed on unit operations and the machinery for carrying out these operations. The ChE lab occupied what I recall as being about half of the East Engineering Building in open bays running from basement level to third (maybe fourth) floor. Permanent equipment included evaporators, reciprocating and centrifugal pumps, heat exchangers, stills, filter presses, centrifuges, mixers, etc., augmented by the temporary equipment set up by candidates for master and doctoral degrees. There were no floors as such; the various floor levels being set out with checker plate and subway grating.

This gave the lab a truly industrial appearance.



Paul Jaronski

James O. Wilkes, F. Drake Parker, and the Badger Trophy, May 1998.

The temporary equipment and piping assemblies that grad students set up for their research projects, in all of their ridiculous or outrageous or obscene configurations, inspired Al Mueller, Claude Peavy, and myself—with the blessing of our mentor Prof. Ed Baker—to create the Badger Pipefitting Trophy. Because Badger was so keen on down-to-earth design of process equipment and practical solutions to ChE problems, we thought that a tongue-in-cheek annual award should go to the graduate student whose research project involved an equipment and piping assembly that was the most imaginative, creative, bizarre, or artistic expression of (or digression from) the principles that Badger so vigorously promoted. The only requirement was that the assembly be operational and functional and have a basic purpose in the student's research project. Accordingly, the trophy was made to symbolize the spirit of amateur pipefitting. Based on some of the photos shown at the May 9th Centennial Celebration dinner, many of today's ChEs could qualify as candidates for the award!

One of the most memorable characteristics of the old ChE lab and seemingly absent from the new ChE lab was *smell*. The old lab reeked of odors including but not necessarily restricted to wet steam, oily condensate, grease, pump packing, lubricants, paint, soy beans, solvents, gas and arc-welding fumes, diphenyl vapors (no EPA or OSHA in those days), acrid vapors from the paper and electro-plating experiments and *sweat*. My all-time favorite smell was generated in the course of work with Claude Clinton Peavy on his doctoral and my master studies of

fractional-distillation equipment. We used as the test material (because of ease of analysis) pure grain ethanol. Although we represented ourselves as expert welders and pipe fitters (in fact—perhaps upper rank amateurs) the constant opening and reassembly of the fractionating equipment to fix reboiler or condenser leaks or to change plates and plate spacing inevitably led to some small(?) dissipation of ethanol vapors. A number of students claimed that they could achieve a modest “high” at zero cost simply by watching us work for a few minutes.

Extracurricular Activities

As noted, part-time work was—for many students—an essential part of college life if they wanted to stay in school.

A five-piece band was formed, romantically dubbed the “Michigan Cavaliers,” to play at fraternity parties and occasional local and out-of-town gigs. One of our gigs was at Joe Parker’s (no relative), which was a turn-of-the-century saloon in the basement of a downtown building. It reopened after Repeal in 1933. There were perhaps a dozen long wooden tables with benches and a small dance floor. On the tabletops were carved the names, initials, and class years of several generations of long-gone students. (Whatever happened to those priceless tables?)

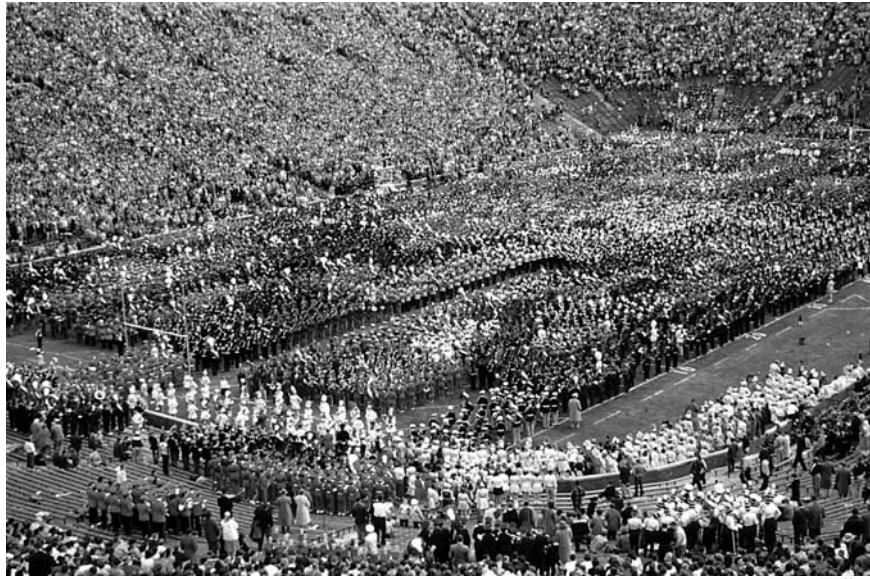

James Wilkes

Drake Parker’s musical interests made us recall the “Band Days” (here from fall 1955) when many high-school bands (183 in this picture) took the field in the Michigan stadium at half-time.

Local 20 of the American Federation of Musicians (Caesar Petrillo, president) had its office on the second floor of Nickels Arcade. Union scale was about

\$2.25/hour for the musicians and \$2.75/hour for the leader. At Joe Parker's a steak dinner was thrown in as a bonus. To get the band and its instruments to our various gigs I bought a 1930 Ford Roadster for \$100. Appropriately enough its body color was blue and its wire wheels were yellow. We drove to our gigs—never mind the weather—with the rag top laid back and the windshield folded down. We were young.

As an upper classman and graduate student I worked as an assistant in the ChE laboratory. As I recall, starting pay was \$0.50/hour, final pay \$0.65/hour. Work on G.G. Brown's engineering research projects paid \$0.75/hour.

From time to time I worked at Leslie Laboratories on the outskirts of Ann Arbor. This was an enterprise established by Dr. Leslie, who was said to be a former ChE professor. He was affectionately called "Make a Million Leslie" because his primary mission was to make a fortune recovering gold from the deposits of that metal in the glacial moraines of Michigan.

Leslie Labs did commercial consulting work. Two of the projects I recall were the production and recovery of furfural (another strong smeller) from oats for the Quaker Oats Company, and the design of a plant to make a whiskey for a start-up operation called Trenton Valley Distillers. The product was advertised as "the working man's friend—aged in the still." In the rush to get distilled spirits on the market after Repeal in 1933, the idea was to separate the potable from the non-potable by fractional distillation with side-stream draws rather than by aging the distillate in charred wooden barrels. The plant worked fine, the product was cheap, working men bought it and could regain sanity after what sociologists called the mind-crushing monotony of eight hours on an automobile production line. Dr. A.J. Good, who later moved on to Upjohn in Kalamazoo, was the lead man for R&D at Leslie Laboratories. Work as an assistant paid \$1.00/hour.

Students

An ever-changing montage of faces and names of fellow students floats through my memory. Some come into focus, then fade away; then others appear and disappear. Then they may all appear together—then vanish completely. Such seems to be the nature of retrieval after six decades. Here are a few of today's characters:

- W.H. "Bill" Davis. A fellow musician (sax) but a much better one. Worked with me briefly during the war years in California, then joined Sun Oil Co.
- George W. Stroebe. We shared an office during our graduate studies. Joined Standard of California, became a golfing buddy along with Fred Hartley (Union Oil) and Ben Holt (C.E. Holt)—the "Fearless Foursome."
- Fred Kurata. An irrepressible and irresistible joker and funster.
- Dysart Holcomb. A dyed-in-the-wool Texan. Married Prof. White's secretary, crushing the hopes of many a grad student. Honeymooned in Galveston, Texas in July. No air conditioning in those days, so some fellow students found this a cause for admiration, amazement, and amusement.

- R.R. “Bob” White. Probably the most serious thinker among us.
- Brymer Williams. Something of a charming enigma even in those days because he had a fine ability to analyze words and actions but coupled this with a reluctance to reveal his findings.
- Claude Clinton Peavy. A serious and tireless worker with a romantic streak. A harmonious companion during our graduate work together on distillation. Always digging out his “flaming answer” to the problem at hand to the tune of “Ah, sweet mystery of life at last I found you.”
- Fayzan Shevket. A young lady from Turkey and the only female ChE student whom I remember. Maybe in my class or a year ahead of or behind me. When in one of Badger’s classes, her presence made him reduce his usual bark to a low growl.
- Al Mueller. A no-nonsense doctoral candidate, working on a long-tube film evaporation project. The senior assistant in the ChE lab.
- Hugo Drasin. A student whose life was tragically cut short by an accident involving a welding torch and a not-quite-empty solvent drum.

And many more who come to mind in nostalgic moods as I recall “. . . those good old college days.” *Go Blue!*

STUDENT LIFE IN THE PRE-WORLD WAR II YEARS

by Clifton S. Goddin, B.S.E. 1936, M.S. 1937, Ph.D. 1965

THE year 1932 was not the best time to graduate from high school. The Great Depression was in full swing and jobs for fresh young grads were non-existent. In my case, there were no funds for college since my father had lost the family nest egg in the market crash and then his job when the Bank of Michigan closed doors. Miraculously, the Mother’s Club of Grosse Pointe High awarded me a \$200 scholarship, enough to pay for tuition, books and streetcar transport for a full year at Detroit City College, (now Wayne State University). A second miracle occurred the next summer when I located a job in the neighborhood Standard Oil service station, which helped finance my sophomore year. My dream to study chemical engineering at the U–M was fulfilled when the opportunity arose to work part time in a new Standard station being constructed in Ann Arbor.

Arriving in Ann Arbor for the 1934 fall term, I soon located a room in an old frame house on South Division Street where home-cooked breakfast and evening meals were available for \$5.00 per week. After registering, I was soon immersed in the chemical engineering curriculum. Most memorable of the early courses were *Physical Chemistry*, enlivened by the dry wit of Professor Case, and *Stoichiometry*, under Professor McCready. The latter course was distinguished by a ten-minute quiz inflicted at the beginning of each class, which soon demonstrated imperative

need for skill in selecting a sound calculational basis and great dexterity in manipulating my new KE log-log duplex slide rule. I still recall McCready's sly grin, (some sensed a trace of sadism), as he passed out the problem sheets.



James Wilkes

Clifton S. Goddin, 1982

by indulgence in one of their renowned extra-thick chocolate milk shakes. Often added a dimension of luxury by studying in the magnificent Gothic library in the relatively new Cook Law Quadrangle.

The new Standard station was located at Catherine & Main, across from the Post Office in downtown Ann Arbor. I reported in at noon and worked till midnight on Saturdays and Sundays. Clean starched uniforms were provided and the pay at 40 cents per hour was a bonanza. On football Saturdays I came in early to help process the heavy flow of traffic to and from the stadium; needless to say, I was quite exhausted, having made the long trek back to my room in the wee morning hours. The weekend gas-pumping activity necessitated doing homework on Friday evening so little time was left to savor extra-curricular activities. However, I did manage to take in an occasional movie at the Michigan Theater and to relax via a late afternoon swim and sauna at the Michigan Union, followed



James Wilkes

The Law Quadrangle, fall 1956.

In the 1935 spring semester I was introduced to the very essence of chemical

engineering, the course in the unit operations taught by the scholarly Professor McCabe, using his pioneering textbook *Elements of Chemical Engineering* (Badger & McCabe).

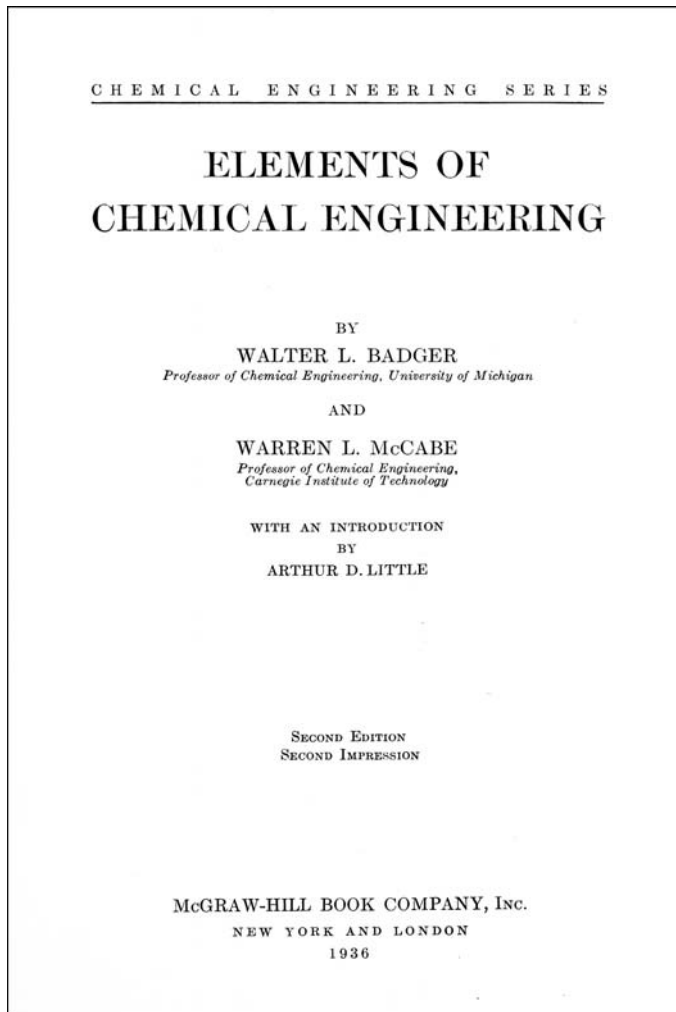

Of particular interest was the famous McCabe-Thiele diagram for determining theoretical trays for separation of two components by distillation. By coincidence, in my first position at Standard Oil's Research Department at Whiting, Indiana, I was privileged to meet the co-creator of the method, Dr. Ernest W. Thiele (1895–1993). A number of years later, an adaptation of the method proved of great utility in designing a train of extractive distillation columns to separate water-soluble chemicals produced by the hydrocarbon-synthesis plant at Brownsville, Texas. Another great undergraduate course was *Thermodynamics*, taught by George Granger Brown, a man of great vitality—intimidating at times—but highly respected for his

the projects. One such involved the assembly of a reciprocating steam pump from parts stowed in a bucket, (WLB always kept a critical component tucked away in his pocket), then rigging up piping to pump water from one drum to another. While our professor was standing by, we started steam to the pump. Alas, a stream of water from a loose fitting drenched him ere he could retreat, muttering profanities.



Paul Jaronski

Stuart Churchill, John Dealy, and Clifton Goddin, 7 October 2000.

On another occasion we managed to freeze up an evaporator vessel by pulling too great a vacuum with the steam eductor. Our written team reports received a succession of zeros. In desperation, we modeled a report after one that had received a top grade of ten the previous year. When this too was rated zero, we knew we were in deep trouble. By an act of unaccountable grace, he awarded me a “D” for the course. I was relieved somewhat, but honor-society aspirations were down the drain.

On an afternoon in June 1936, I was working in a laboratory across from the unit operations bay in the East Engineering Building. Suddenly there was the roar of an explosion and the transom windows came crashing down. I ran across the hall and found the department head, Alfred H. White, already at the scene, deeply shaken and leaning over the victim of a fatal accident. A master’s degree classmate, Hugo Drasin, had started to cut the head from an empty solvent drum with an acetylene torch. Apparently, due to an explosive gas mixture in the drum, the drum-head blew out, killing him instantly. It was shocking to realize how quickly a compatriot with a fine mind and promising career could be destroyed.

One of my last memories was walking down the hall in the East Engineering Building, feeling quite good about having accepted an offer to join Standard Oil’s

Research Department at Whiting, Indiana. Encountering my nemesis, Professor Badger, I couldn't resist telling him of my good fortune. He inquired: "How much are they paying?" When I responded: "\$175 per month, tops for an M.S. degree," he gruffly asserted: "Too much!"

THE CLIFTON S. GODDIN PRIZE

CLIFTON ("Clif") Goddin was born in Richmond, VA, but moved to Detroit at an early age and then settled in Grosse Pointe, where he attended high school. As a student at the University of Michigan, he received his bachelor's degrees in both chemical engineering and mathematics in 1936, and his M.S.E. in chemical engineering in 1937. He then joined the Research Department at the Whiting Refinery of Standard Oil of Indiana, and was fortunate to participate in the exciting push to develop catalytic refining processes to replace conventional thermal reforming and cracking.



Bob Kalmbach

James Wilkes, James Duderstadt, Clifton Goddin, Jerome Schultz. Engineering Dean Duderstadt receives an Amoco Foundation check from Dr. Goddin, June 1984.

Called up by the navy in 1941, Clif spent five years on active duty during World War II, including two years on Bahrain Island, expediting navy tanker loading and providing liaison for navy gun crews on merchant vessels carrying war supplies for

Russia. Following the surrender of Japan in 1945, he volunteered to serve on the NavTechJap team sent in to ascertain the state of Japanese petroleum technology.

In 1946, he joined Standard Oil's Production Research Department in Tulsa to work on the design of the chemical-recovery section of the large hydrocarbon synthesis plant at Brownsville, Texas. Following the shutdown of this plant (due to declining value of the synthesis oil product and rising cost of the natural gas feed), he was assigned to a task force to trouble-shoot startup of Amoco's pioneering xylene-oxidation plant at Joliet, Illinois. This process ultimately proved quite profitable as demand soared for terephthalic acid, a primary component of polyester.

During one of the periodic lulls in the industry, and desirous of brushing up on the "New Engineering" following the launch of Sputnik, Clif took an academic leave to pursue a Ph.D. in chemical engineering, again at the University of Michigan. Under the guidance of Prof. Jim Wilkes, he completed his dissertation in 1965, on the numerical simulation and experimental investigation of water flooding of stratified oil reservoirs.

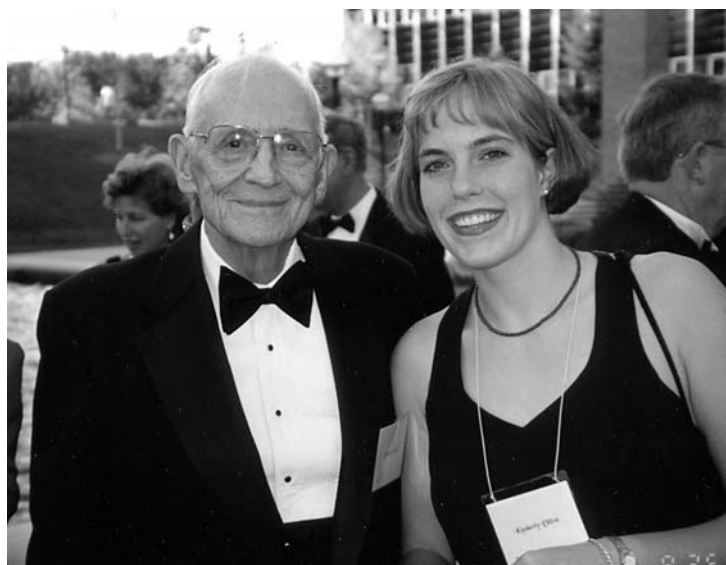

James Wilkes

Clifton Goddin and Kimberly Dillon, the 1997 Goddin prizewinner.

Resuming his career in Amoco Research in Tulsa, Clif was involved in a nicely diversified series of projects, including writing a computer program for the design of sulfur-recovery plants, and evaluating alternate energy sources such as geothermal energy. An important assignment before his retirement as a senior research associate in 1984 was the identification and semi-commercial-scale demonstration of optimal processes for recovery of carbon dioxide from miscible flood effluent gas.

Along the way, Clif authored or co-authored 18 U.S. patents. He is currently actively involved with the Engineers' Society of Tulsa. His reflections on his undergraduate years at the U-M appear earlier in this chapter, on page 387.

The annual Clifton S. Goddin Prize recognizes a third-year chemical engineering student who has displayed outstanding qualities of leadership and scholarship. The recipient is presented with a framed citation and a significant cash award at the Engineering Honors Brunch held in March each year. Clif established the award to express gratitude for the most excellent education provided him by the University of Michigan. Photographs of the eighteen Goddin prizewinners to date appear below.



Tia Marie Badalamente (1985)



Alvin Dodek (1986)



Kent Kimerer (1987)



Patrice McCullough (1988)



Andrew Pasternak (1989)



Laura Van Wormer (1990)



Amy Dawson (1991)



Melissa Babcock (1992)



Brian Balchunas (1993)

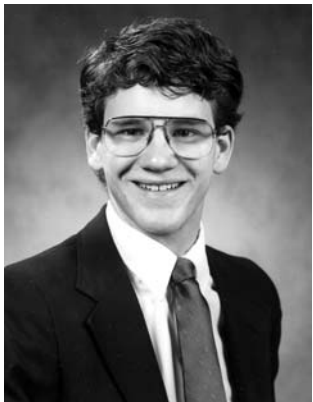

Ben Specht (1994)

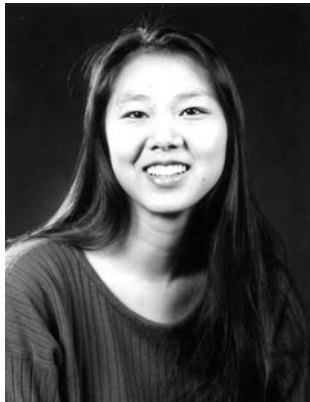

Angela Yeh (1995)



Lee Brooke Claycomb (1996)



Kimberly Dillon (1997)



LaRuth McAfee (1998)



Maureen Hindelang (1999)

*Kristina Wheaton (2000)**Anjan Chakrabarti (2001)**Eric Roeder (2002)*

REMINISCENCES OF THE 1930s

by Gerard W. Mulder, B.S.E. 1935, M.S.E. 1936, Ph.D. 1940†

Introduction. I am happy to reminisce about the College of Engineering as it was in the 1930s while I was a student. Those were the days, my friend. I hoped they would never end. But they did. My progressions since that termination were vastly better than it would have been without the education I received. It pleases me greatly to review the days and the progress. First, a bit about my background.

I am a product of a Dutch family. Mother was born in the Netherlands and the family arrived in Ada, Michigan in 1893 when she was six years old. Father's father crossed the ocean on a sailing vessel in 1873 and was one of the settlers of Zeeland, Michigan. My grandmother, his wife, was born on the shore of Lake Michigan, between what are now Holland and Grand Haven. She was the first child of the Van Raalte Colony (a minister-led group of colonists from the Netherlands) to be born in their new country. The Van Raalte group arrived in 1848.

My father was raised on a farm south of Zeeland, graduated from Calvin seminary in Grand Rapids, Michigan and became a minister and a missionary upon graduation in 1908. I am the second child of that marriage and was born in 1913.

Before the U–M, schooling was entirely parochial through grade school and high school. I then had two years of pre-engineering education at Grand Rapids Junior College. Because I had insufficient funds to go to the U–M, I lived at home and went to Calvin College and graduated from there with an A.B. degree in 1933.

My trip to Ann Arbor to enroll in chemical engineering was made in the fall of 1933. I had savings of \$348. A week after entry into the college the banks failed,

† This article was sent on August 27, 1997 to Brymer Williams by Dr. Mulder, who lives in Milton, Wisconsin.

and I never saw my \$348. Money was a problem for me in the undergraduate school but it became solved through many jobs, including waiting tables at Ma Freeman's eating place on Huron Street.



Original laboratory benches in East Engineering, typical of those used by Gerard Mulder—and indeed by many others until the move to North Campus in 1982.

The department. The undergraduate portion at Michigan was the most noteworthy to me. There was quality and diversity in the teaching staff. Since this is all over 60 years ago, I may have forgotten some of the names of people that impressed me. As able teachers, I remember J.C. Brier, Warren McCabe, W.L. Badger, C. Upthegrove, Don McCready, E.M. Baker, G.G. Brown, and A.H. White. And, outside the department, O.W. Boston and G. Gwiazdowski.

The standards set up by this group, as well as the entire faculty, were high. We were there to learn and we were on our own. Cheating in an examination was not known at the engineering school. The opening remarks of W.L. Badger, spoken as he paced the floor of the lecture hall, twirling his Tau Beta Pi pin, were “Look each other over very carefully. By October (of 1933) one third of you will no longer be here. Our work load is tough.” This did put the fear of God in me, but I learned to admire that man. He was there for his ability and he did know how to get his lessons across.

In 1935, when I entered the graduate school, as well as joining the Department of Engineering Research, I was assigned Room 3219 in East Engineering, which had a desk, some laboratory workbenches, a ventilation hood, and an analytical balance. It was adjacent to J.C. Brier's office. On several occasions I helped him establish a collection of data on explosives. As early as 1936, army and navy personnel came to Ann Arbor for Brier's graduate course in explosives. As a master's thesis, I designed a plant to be placed on the Huron River, for the manufacture

of picric acid. It was my thinking that picric acid would have precedence over tri-nitrotoluene as our basic high explosive. A plant to produce picric acid was built outside Grand Rapids in 1917, but never operated.



Original type of East Engineering fume hood.

As a student during this period of history, I felt that the U.S. was behind Europe in its scientific development. Even Russia, according to the literature at that time, had developed counter-current nitration of TNT. The picture has vastly changed since that day. We are now, without question, the leaders of the scientific world.

Late in 1935 I became an associate in the Department of Engineering Research. The work projects were based on requirements and requests of various industries to develop products or processes that were outside of the normal ability of a company to develop themselves.

One of the seed companies had large accumulations of undersized or out-of-date seeds that normally were marketed and they wanted to know if there was any value to the unmarketed seeds. Should they be scrapped? These seeds were at their growing gardens in California. We analyzed these products and found several that had value because their oil had properties suitable for specific lubrication usage.

One of the seeds was celery seed, which contains an essential oil, then currently on the market—all of it coming from France. Work was done to extract the oil and get a product that met existing commercial standards. I left Ann Arbor in early 1939, when we were marketing celery-seed oil made in our chemical engineering laboratories. When World War II was finished I was told that celery-seed oil was

made in the laboratories all during War II, but I never verified this statement.

Hanji Sohma

1869 -

A graduate in Chemistry of the Kuramaye Engineering School in Tokyo in 1896, he became an instructor and was sent abroad by the School in 1900 for research in sugar and oil. After a year of study in Germany he came to the United States and enrolled as a graduate student in chemical technology at the University of Michigan in September 1901. He received the degree of M.S. in 1903.

Upon his return to Japan he utilized his special knowledge of sugar manufacture and ultimately became the founder and head of the "All Meiji" Bloc consisting in 1937 of 7 cane sugar mills, 5 alcohol factories, 2 beet sugar mills, 4 sugar refineries, 23 confectionery factories, as well as various other affiliated industries and 68 wholesale distributing stores.

Mr. Sohma, representing the University of Michigan Alumni in Japan, came to Ann Arbor to attend the Centenary Celebration in June 1937 and presented a gift of 100 cherry trees to the University. At that time he made a verbal offer to give 10,000 yen to the Department of Chemical and Metallurgical Engineering and confirmed it by his letter which appears on the left.

In honor of Mr. Sohma and in appreciation of his gift through which this laboratory was established it has been named the

Sohma Precision Laboratory.

Hanji Sohma citation.

The Department of Engineering Research was a proven asset for the several industries in Michigan that simply did not have the staff to solve their many industrial problems. These laboratories provided a source of earning money for students. It also provided a hands-on means of learning as well as a good knowledge of industrial problems that students would face. It pointed the way for practical and beneficial operations of new methods of manufacture. Additionally, it provided funds for the university for needed new equipment. I think the Sohma Precision Laboratory came into existence because it was needed for industrial development applications. [*Editor's note: the East Engineering Sohma Laboratory contained much equipment for accurate physical measurements, and was made possible by a very generous gift from Hanji Sohma. The essential points of the story can be gleaned from the accompanying five illustrations.*]

It amazed me, as a student, to discover how little some in industry knew of the development side of their businesses, and how firm the need was for chemical engineers in business in the 1930s.

Another project that we had was the development of industrial usage of soya beans. Solvent extraction was just becoming a reality, and we extracted the beans ourselves and established a process for segregating the protein.

Much pioneering work was done in utilizing soya-bean protein as a substitute for casein in paper coating. I was told later that soya-bean protein from our laboratories was used to replace casein in the paper coating for the first issue of *Life Magazine*, although this was never verified. I received satisfaction from having a name on the patent for segregation of the proteins.

Social life. Now I could tell you more but let's discuss the fun and life that we had in Ann Arbor in the 1930s.

The barbecue on the corner to the rear of the East Engineering Building often supplied my daily lunch. A bowl of chili was a dime and several cups of coffee were five cents. This became my regular lunch. By the latter part of the week the chili was rather thin.

John Hannum was a graduate student and had the room on the other side of J.C. Brier's office. He was expert at glass blowing and had the complete assembly for all the operations of manufacturing of a chemical on his desktop.

One evening we took his Austin automobile up the freight elevator and parked it in the hall. We often worked in the labs at night. In the very early morning hours he looked in the parking area for his car and came up to the lab to report it as stolen. After we "looked" for it for quite a while, it was "found" in the hall next to his office door.

I married Alyda Dykstra, then a nurse at the University Hospital, on December 19, 1936. We have passed a rather large milestone last year—60 years of marriage. It has been a wonderful marriage. My father tied the knot—it was a tight one.



Hanji Sohma (Shimotome), while a student at the U-M, April, 1903.



Portrait of Hanji Sohma, received September 1930.



THE PLAZA
FIFTH AVENUE AT 59TH STREET
NEW YORK

Mr. A. H. White
University of Michigan

New York City June 16 '37

Dear Sir,

I congratulate myself to have attended the
100th Anniversary of the University

As I have reported to you, I am sending you \$1,000⁰⁰
which is \$2,865⁰⁰ under the exchange rate to-day through
Mitsubishi Bank of New York City.

Anything you would do with it for the benefit of
the Chemical Engineering Department of the University
will be much appreciated by me.

We much enjoyed to have had you and Mrs.
White's kind invitation of tea. Kindly remember us
to Mrs. White

Your very truly

H. Sohma

Hanji Sohma letter to A.H. White.

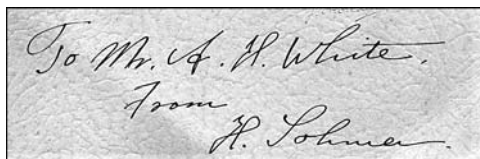

Hanji Sohma signature as it appeared below his 1930 photograph.

One night at the laboratory a friend, who was working on a doctoral thesis in the physics lab located across the street from the East Engineering building, came running over to tell of the great advance he had made in his work. He worked on a cyclotron, about four feet in diameter. In a roll of film he had a white line that split showing electrical fission. It didn't excite me because I didn't realize the importance of that result.

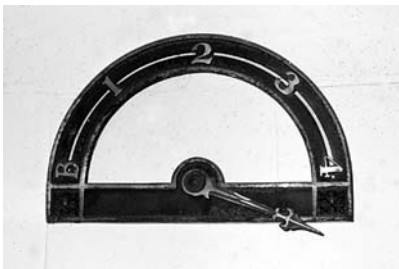

James Wilkes

The elevator occasionally hit the ceiling, East Engineering, 1964.

My good friend Olaf Bergelin was working on his chemical engineering thesis at the same time. The previous paragraph reminds me that I was the one who named 23 officers from Ordnance to join in the Manhattan Project back in 1943 and he was one of them.

My fraternity association was Phi Alpha Kappa, at that time located at 1000 East Ann Street. It had begun as a fraternity in about 1929. Many of its members were Calvin College graduates, mostly going on in medicine. Fraternities and sororities were under stress all during the Depression. Many of them were closed. Phi Alpha Kappa purchased their first home in 1930 and occupied it till some time in the 1960s. We "burned the mortgage" in 1934, the year that I was business manager. The cost of the home in 1930 was \$25,000.

Ann Arbor was a small, quiet town in the 1930s, perhaps a population of 8,000 without the students. The *Orient*, from "Back to Joe's and the Orient," was no longer in existence when I came to the campus.

Why did I like the University of Michigan? I liked everything about it but most importantly the quality of its education and the fact that it was willingly offered by

superior professors. It encouraged me to do my thing. It gave me freedom to think and act. It permitted me to attend classes and to audit a course when I didn't need to take it for credit. For example, when I became involved with celery-seed oil, I audited a course called *Chemistry of Heterocyclic Compounds* over in the Chemistry School. This class was taught by Dr. Werner Bachmann, a renowned German chemist, and I got a great deal out of it. I did a similar thing to get a little more involved with accounting, by auditing a course over in the Business Administration School. Now I do not know whether this kind of thing is permitted, but it served me well. On occasion, I also took in one of Dr. Novy's class lectures over in the Medical School. This, however, was mainly fun even though most of my fraternity brothers were either medical or dental candidates.

While the education I received was in a specialized area, it was the method of receiving it that gave it worth to me. My later occupations generally did not deal with chemical engineering. The education, however, gave me the tools of the trade to apply as they were needed. Having spent five years in World War II and two years in the Korean War, my normal development into engineering fields never materialized. Nevertheless, what I learned from competent teachers has always held me in good stead. Were it all to be done over under similar conditions, it would be done the same way.

One area that I remained allied with in most of my adult life has been military ordnance. This has been both as an army officer and in the manufacture of materials required by the Armed Services. I have also been involved in a number of NASA projects.

Norman Appold was a chemical engineering student who worked with me on some of my Ph.D. work. I met with him again in 1952 at the U-M. Each of us was named a distinguished alumnus of the university in connection with the Centennial Celebration of the Engineering College. After the war Norman had stayed with the Air Force to become head of the Wright Patterson Air Force activity in connection with the development of the B-52 bomber. I had seen the first B-52 at Elgin Air Force Base shortly before this Centennial Celebration.

In my doctoral thesis there were some 250 runs that were made, mostly at night, collecting the data. It took about three hours to compute the data for each of the runs. In today's computer age, perhaps the whole thing could be computed in one day.

We stopped the farm operation two years ago when my manager wanted to retire. We continue to live on the farm. In this closing we reported the farm effort in some detail. A copy of this story is appended to this letter. It was also time for me to retire.

May God continue to bless you, Brymer. Continue to enjoy your retirement years. You have certainly earned them through all that you have done in Ann Arbor.

**THE CHEMICAL ENGINEERING
STUDENT'S LIFE IN THE 1950s**

by **Peter B. Lederman, B.S.E. 1953, M.S.E. 1957, Ph.D. 1961**

THE 1950s were an interesting time for the chemical engineering student at Michigan. It was a decade of many changes. It began with the slide rule as the key instrument for computation and ended with the computer already in heavy use for analysis. It began with the new Brown's *Unit Operations* approach and ended with Bird, Stewart, and Lightfoot's *Transport Phenomena*.



Peter B. Lederman

Those shifts alone made life a challenge for students and instructors. During that time chemical and metallurgical students worked closely together, were in the same department, and took many of the same courses. Student life centered around the Main Campus, and particularly East Engineering, where all the chemical and metallurgical engineering laboratories and courses were held. Only in the late 1950s did some of the courses, particularly laboratory courses, move out to the North Campus, where student life is now centered. Many things were the same, but many things were different. Students were not allowed to have cars on campus, lived primarily in dorms and fraternity houses and women had a 10:30 PM curfew. Discrimination, possibly, but at that time the university acted *in loco parentis*. The class demographics were different; there was one woman in the Class of '53E and less than ten percent women even in the late 1950s. Drinking alcohol was prohibited and penalties were heavy if a student was caught violating this rule. There were few restaurants; Ann Arbor was a dry town and did not vote for liquor by the glass until the early 1960s. Beer drinking at some Michigan classic watering holes, e.g. the Pretzel Bell, was an exception. Social life centered around the Michigan Union and the Women's League, the fraternities, and the dorms. "Off-campus" living in private homes was the unusual mode of life, whereas today it is the standard. Cars were essentially non-existent, as students were not permitted to have them on campus, which meant Ann Arbor.

The early 1950s saw the end of the World War II veterans' bubble. Those of us who went to school then knew that these folks were serious and hardworking and competition was stiff. No nonsense was the name of the game. That approach pervaded work and study throughout the 1950s for all chemical engineering students, who were a group apart, even from the beginning.

In the freshman year, chemical engineering students had to start taking advanced chemistry, deviating from the more “common” engineering curriculum. In the first semester of their sophomore year, students began with the first of many chemical engineering courses. The chemical engineer thought he knew best, and took very few courses from the other engineering disciplines. Thus, chemical engineers became a group unto themselves, self-supporting, hardworking, and somewhat apart from some of the engineers, and certainly from the rest of the university. Chemical engineers were a bridge in a sense, because they took more chemistry than any other engineering group and almost as much as the chemistry majors. This, alone, set the Chem-Es apart because they were not chemists; they were engineers taking many specialized engineering courses as well as the chemistry. The chemical engineers chafed that they had to compete with pre-meds who needed high grades and were not bound by the Engineering College Honor Code. But we all got through these, and many other small, and now, looking back, insignificant hurdles.



East Engineering in Peter Lederman's student days (1955).

The chemical engineering student felt somewhat elitist and probably rightly so. But this did not mean that there were no other contacts with outside groups. The dorms and the fraternities were most important in establishing ties outside the department.

There were a number of memorable people and learning opportunities that affected all our lives. All freshmen were introduced to engineering by A.D. Moore in his non-credit orientation program, which lasted the full year. Not for credit did not mean no work. “A.D.” (see also page 615) was famous for making sure that you pulled your weight. Other introductions for all engineers, at that time, were

engineering drawing, not one course but three, and engineering materials, which was taught in the Chem-Met Department. In the former, the nemesis for chemical engineers were the “ink on vellum” drawings. The engineering materials courses used a text by the former chairman of the Chemical & Metallurgical Engineering Department, *Engineering Materials*, by A.H. White. It introduced us all into the world of materials, concrete, steel, welding; you name it and we had an exposure. That stood us all in good stead throughout our careers. From then we took “real chemical engineering.”

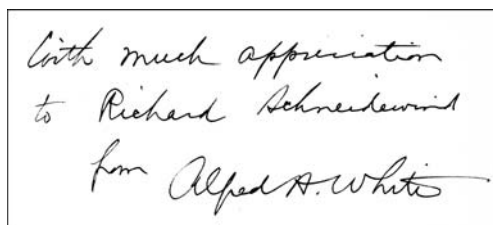

With much appreciation
to Richard Schneidewind
from Alfred A. White

The October 1940 inscription in Prof. Richard Schneidewind's copy of A.H. White's book, "Engineering Materials."

Chemical engineering and metallurgical engineering in the fifties were traditional disciplines. That is, we used the unit operations approach and really were trained to be process engineers. For the metallurgist it was physical metallurgy, metal processing, and foundry, as well as some basic chemical engineering courses. The chemical engineers also took physical metallurgy, but just not as much as metallurgists. This enabled the students to develop a professional camaraderie as well as some competition. But on the whole, it was a tight-knit group.

Earlier, I stated that the chemical engineers were the bridge between chemists and engineering, and so they were. One chemistry course per semester, usually with lab, kept everyone busy. Probably one of the most memorable characters of the fifties was Lee Case, who taught physical chemistry. Professor Case had a string bow tie, would come into class with a quick smile and say “good morning,” and then proceed to fill all the blackboards. When he needed to do calculations, he knew the logarithms by heart and could do it faster than you could do it on the slide rule. A most impressive display of mathematical, computational and chemical skills! He always awed the students.

On the engineering side, it was equally hard. Material and energy balances was, for most, a “killer” course. Grades for the first exam typically averaged 10 out of a possible 100 points. By the end of the semester we understood problem analysis and solving and most of us managed to get through. Then we were hit with thermo, followed by unit operations, and finally, laboratory and design, the “fun” courses. The unit operations laboratory in the old three-story lab in East Engineering included many experiments; it was often really a puzzle because we had to learn

to work with real machines and real equipment. One could get passively drunk, also, because we distilled ethanol. If the distillation column leaked (which it often did) over the eight hours that you were in the laboratory working on that column, you inhaled enough alcohol so that you could go home in a stupor. Fortunately, no one got hurt. The laboratory folks were always helpful—the professors, the teaching assistants, and the technician crew led by “Fanny” Bolen.



The Michigan Union.

By the end of the fifties, computers were in vogue and the Chemical Engineering Department was a leader in that effort. Some of the people who led that effort are still around, but the person who was the spearhead, Professor Don Katz, chair and principal investigator of the Ford Foundation Project, is no longer with us, but left his mark in so many ways, including guiding students, and encouraging everyone to become a professional engineer. His comment was “once you have it, you can’t lose it and you may need it one day.”

Towards the end of the fifties, some of the classes moved out to the North Campus. The first of those was the unit operations laboratory, followed by lectures. North Campus, of course, has become the new home of chemical engineering. The tradition of all those years, of which the fifties were the middle years, goes on.

The most memorable aspect of chemical engineering studies was the close camaraderie between faculty and students. The faculty all had industrial experience,

with a strong balance between theory and practice. They were all wonderful mentors, but tough task masters. A 20-credit semester was OK with them if you could get through the Barbour Gym registration with your “railroad ticket”—no computerized registration—waiting in lines for each separate course was the requisite process. Life in the fifties was good. We worked hard, and played a little, too.



James Wilkes

Looking to North Campus from the hospital, 1955.

ANN ARBOR, THE UNIVERSITY OF MICHIGAN, AND THE CHEMICAL ENGINEERING DEPARTMENT, 1963–1967

by Sidney F. Sapakie, B.S.E. 1967†

The Times

IN many people’s mind, the era known as the “sixties” actually began on November 22, 1963. On that day, I was sitting in West Engineering waiting for a freshman English class to start and wondering where the professor was. One of my classmates, who was very active in the campus Republicans, entered and informed us with what seemed a bit of tongue-in-cheek, that JFK had been shot. We soon found out he was correct. A pall settled over Ann Arbor as it did for most of the country. It seemed a week before people started talking in voices louder than a whisper and class returned to some semblance of normality. I’ve heard it said that my generation would always remember where they were for two events:

† Sidney F. Sapakie is vice-president for international research and development at General Mills in Minneapolis, and is the president of AIChE during 2002.

Kennedy's assassination and the first moon landing. For the former, I was in West Engineering and will never forget. During the rest of my four years in Ann Arbor there was much going on, as there was on many campuses. My time was full with classes, labs, homework, participant and spectator sports. I did not experience, except in passing, the protests, teach-ins, marches, etc. that reflected the times at the University of Michigan.

Ann Arbor

For a kid from the suburbs of New York City, Ann Arbor seemed like a small town. Since cars and the precious E-Sticker were only permitted for seniors, the rest of us out-of-state undergrads knew the town to the extent it was walking distance from the campus. Movies, concerts by the likes of Peter, Paul & Mary, and the Smothers Brothers at Hill Auditorium and Hockey Night in Canada on CKLWTV (before cable) together with U-M football, basketball, and hockey represented much of my nonacademic time. When I needed some exercise, the IM Building was both an outlet and a workplace, as I refereed intramural sports. Restaurant choices were limited and due to my lack of funds, my occasional outings were to Steak & Shake, and the Brown Jug on South University, while books and campus paraphernalia were bought at Ulrich's or Follett's.

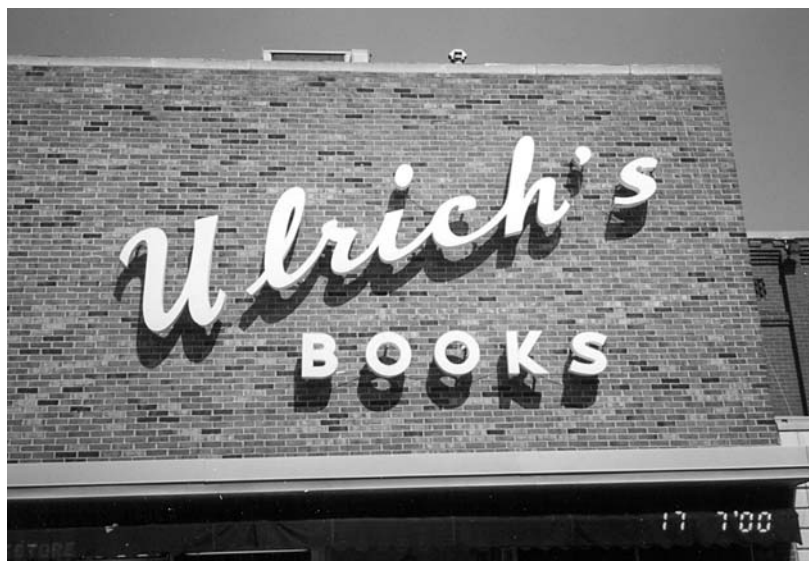

James Wilkes

Ulrich's Bookstore, just south of the East Engineering Building, is still going strong (July 2000). Other student bookstores such as Follett's, Wahr's, and Overbeck's have long since closed. Newcomers include Barnes & Noble in the Michigan Union and Michigan Book and Supply in the old Kresge store.

When my parents or relatives came to town, dining at the Pretzel Bell was a must—great steaks, brown bread, and walls full of U–M athletic pictures. Tables were covered with carved initials and once we turned 21, the P-Bell was one of the spots to go. My senior year, Bimbo’s, with its “oompah” band, peanuts, beer, and sawdust floors became a popular hangout as well. Ralph’s Market on Packard was the only place in town to get a bagel and some lox. On Sunday mornings, a long line snaked through the aisles.

I moved into the University Towers Apartments in September 1965 before they were finished. It was the first, and perhaps still is the only high-rise complex in the campus area. We had milk delivered to our door and often went downstairs to the “Satellite” fast-food restaurant late at night. The leftover 15-cent hamburgers were only 5 cents. We piled four of us into my friends’ VW beetle about once a month to drive out to a grocery store. Ann Arbor, of course, was one of the first towns to discover pizza delivery and, when our finances permitted, we ordered from Cottage Inn or Domino’s.

The University of Michigan



Sidney F. Sapakie

I was attracted to the U–M because it was a highly prestigious academic institution with excellent athletics and a social atmosphere more relaxed than the eastern schools attended by many of my high-school classmates. I was assigned to East Quad where my roommates and I got along, but due to the efficiencies of the university bureaucracy we had, of course, little in common. Everyone knows the downside of “quad” life, but I did make a number of friends, and worked on my bridge, as our “house mother” hosted a game almost every night. My naiveté was burst as I tested the fraternity system and found it unwelcoming for people like me. Nonetheless, my four years at the university were exciting and rewarding. I was able to pursue my interest in history while still majoring in chemical

engineering. Because of the diversity of excellence at the university, I tested such areas as nuclear engineering, psychology, and geography as well.

Athletic excellence seemed to blossom in the mid-1960s. The ’65 Rose Bowl, the Cazzie-Russell-led basketball team, a hockey renaissance, and success in so-called minor sports were highlights on campus. As I recall, Michigan ended Indiana’s seemingly endless unbeaten streak in swimming. Camping out all night, waiting to get basketball tickets for important games, seemed fun at the time.

Other memories include the seemingly endless trek through the old Waterman Gym, waiting in line after line to register for each term. My introduction to exam

files came via an organic chemistry professor reputed to give the same exams every year.

The Michigan Union, a male-only organization at the time, provided pool tables, study rooms, and a bowling alley in the basement that didn't yet have automatic pin-setters. Our team, the "Church Key's" sponsored by Stroh's, did well. One of the members of our league was a young football player, named Ron Johnson, who went on to quite a career.

Ethnic diversity was not a fact at U-M in the 1960s. The number of African Americans was embarrassingly small, and the stirring of a reaction to that fact could be felt. As I recall, there were also no women in the Chemical and Metallurgical Engineering Department. Fortunately, significant progress has been made on both issues.

The Chemical and Metallurgical Engineering Department

Like many, I was in engineering initially because I was good in math and science in high school. I soon found out everyone else was as good or better, and had to relearn my study habits. I almost failed engineering graphics as a freshman because I didn't take it seriously, but balanced out with an A in speech (A grades were not nearly so common then as now). During the second term of our freshman year, we had to choose a major. We went around to get input from faculty, but that didn't help much. I picked ChemE because I really liked chemistry.

The first ChemE class was amazing. Some of the smartest people I know found it so difficult they dropped out, but I loved it. As the years went on, I liked it more and more despite the difficulty. I remember a thermodynamics exam in which the second highest grade in class was 15 out of 100. Of course, one of my classmates got a 98. He was too smart, for me at least, and went on to become a professor at Carnegie Mellon.

Engineers were immediately recognizable on campus by the slide rules we always carried. I still have my Post Log/Log Deci Trig, which seems like an antique to my family. Boxes of punched cards were also common as we tried to master the MAD and UMAP languages, while avoiding keypunch errors.

The faculty were a mixed bag. Some didn't care a lot about undergraduates and others were wonderful. Professor Lloyd Kempe introduced me to biochemical engineering, which led me to my career in the food industry. Dr. Kempe became a friend and a mentor as our relationship continued after my graduation. Professor Jerry Schultz gave me a summer job and my first introduction to real research. He also was a mentor of sorts as we pursued our mutual interests in the bio area. Professor Wilkes had a desire to teach and it made him popular with students. Professors Curl and Powers were known for the toughness of their classes but they made us learn. Professor Balzhiser liked to talk football as well as thermodynamics so I, of course, enjoyed his class.

What was then called the “fluids lab” on the North Campus had the long-tube vertical evaporator, rotary vacuum filter, double-pipe heat exchanger, and distillation column, which were used in the senior lab. Almost every ChemE class had a lab attached, which provided valuable hands-on experience. My senior project was designing a plant to produce beta carotene via fermentation. In order to graduate in four years, which seemed important in those days, I took classes during the summer after my junior year.



Distillation column used in the ChE 460 laboratory, with Brymer Williams (R).

Over the years, the University of Michigan and the Chemical and Metallurgical Engineering Department have been important in my life. I believe I was taught the critical skill of thinking logically and solving problems as part of my chemical engineering education. In my opinion, this was an important contribution to whatever career success I've attained. I have led our company's recruiting efforts on campus, and have developed ongoing friendships with some of the current and past faculty. And, of course, I have celebrated and suffered with our athletic teams.

TENSE MOMENTS**by Russ Helfand, B.S.E. 1984**

I suppose if you asked most alumni of the Chemical Engineering Department, they'd tell you that there was one moment, one terrifying moment, when they were certain beyond all doubt that they wouldn't make it, wouldn't graduate. Maybe it was during that midterm exam in *Thermodynamics II* when the previous week's accumulation of study and stress culminated in a mind so blank as to make a Zen monk proud. Or, it might have been that moment in *Senior Design Concepts* when the professor asked your opinion of adding another tray to the distillation column being designed on the chalkboard and the most intelligent response you could manage was a low, guttural, "Uhhhhhhhh, ummmmmmmmm, urrrrrrrrrrrr."

Me? My moment of certain doom came at the start of junior year. And, I was all alone when it happened.

Like many students, I earned pocket money during school at a succession of menial jobs. As a freshman I washed dishes in the dormitory cafeteria. As it turns out, this was a cherry of a job with perks like free access to the ice-cream machine (a privilege I imagined, incorrectly, that would endlessly impress girls). By junior year, my inflated ego demanded that I seek more distinguished employment. So, when the chance to work at the microbiology laboratory came up I jumped at it. I remember how proud I was on my first day. Finally, I was going to be a scientist. I reported to the supervisor, a woman of stern demeanor and large proportions, who explained what my responsibilities were to be: the lab used a great many pipettes, beakers, and Petri dishes that had to be cleaned daily. A dish washer. That's what I was to be. Again. Ah, but I was a dishwasher who got to wear a lab coat, a perk I judged to be even more valuable than access to the cafeteria's ice-cream machine.

I can clearly picture the first time I pushed my little cart down the lab's hallway, stopping in each room to retrieve the day's dirty glassware. Just inside each doorway was a tub where the used beakers and other large glass pieces accumulated. Carefully, I added these to my cart's growing mountain of gooey, slimy wares. Apart from the tub of slippery beakers, each lab room had a tall barrel for the used pipettes. These swam in a unbelievably odiferous cocktail of equal parts water, anthrax, and bubonic plague. I had been working at the lab for a week before anyone mentioned that it might be wise to wear the big rubber gloves before dipping my hands into the barrel to retrieve the pipettes.

After making the rounds to collect the day's dirty dishes, I returned to my little work-room where my various cleaning equipment resided. There was the thing I dubbed the "atomic dishwasher," a large metal box that sprayed superheated steam and jets of hot water over racks of dirty jars and beakers. There was the Marquis de Sade salon, a corner of the room where an endless variety of bristle brushes and other torture devices hung on hooks. And, there was the "acid wash,"

which was a long lab table with a sink at one end adjoining a row of very large glass buckets filled with purple acid. The last bucket, furthest from the sink, had the strongest concentration of acid. Each successive bucket was more dilute.

Anything immersed in that last bucket would emerge completely clean in moments. Of course, the acid itself had to be rinsed off before the glassware could be used in the labs. That had to be done carefully because, as it was explained to me on my first day on the job, when you mix concentrated acid directly with water an enormous amount of heat is produced. The trick, then, was to move each piece of glassware through the succession of acid concentrations found in the row of buckets. By the time you reached the last, most dilute, bucket the remaining film of acid could be washed off in the sink without danger.

Naturally, one could not simply dunk a beaker or vial into these buckets of acid. I had to wear a full regalia of armor (a Plexiglas face-mask, arm-length rubber gloves, and a splash-guard that covered my chest). To manipulate the glassware, I used a two-foot-long set of tongs. These were rather difficult to manipulate, like the world's longest chopsticks, so I was constantly fishing around in the buckets to retrieve inadvertently dropped glass pieces.

And that's how it happened. One day, as I was using these damn chopsticks to maneuver a large glass beaker into the dreaded "last bucket," the one filled with the most deadly and concentrated acid, I lost control. The beaker escaped the clutch of the tongs and plopped into the bucket. It all seemed to happen in slow motion: the beaker slipping free, falling inch by inch downward towards the viscous purple acid, the splash as it entered the bucket. The splash. And the quivering blob of hot acid that arose from the bucket. Sailing at me through the air. Like lava. A rising arc. A liquid bomb that was headed for my head. And it was at this moment, this horrible, horrible moment, that I was sure I would never graduate.

My thoughts just then: "That thing is going to hit me in the head and it's going to instantly eat through my skull and dissolve my brain where I've been storing all those Maxwell equations and if I don't have those formulas I won't be able to pass my physical chemistry exam next week and I won't graduate."

I was sure of it.

Fortunately, while I was thinking these awful thoughts my legs were acting with a bit more intelligence by backing, rapidly I might add, away from the path of the acid projectile. So I am happy to report that the acid blob missed my head and my brain did not, in fact, dissolve.

Unfortunately, the acid did not miss me completely. The elation I felt as I suddenly realized that my brain was safe was replaced by the certain knowledge that the landing zone was further south. Even today if I close my eyes I can see it. The undulating glob of acid, the size of a cherry, zooming in on its target: three inches below my belt buckle.

At this point instinct kicked in. Primitive instinct. Animal instinct. Sexual instinct. Yes, that particular lobe of my brain started screaming at the other lobes, “Hey, wake up, we’ve got an emergency here; we’ve got about one second before we can kiss goodbye any chance of getting a date with that cute girl we met last Thursday.” After all, my crotch was in imminent danger.

The sink had an ancillary spray nozzle on a hose. Somehow I managed to get the water turned on and started to hose myself down. Now, as I mentioned earlier, mixing water with concentrated acid produces lots and lots of heat. I was now getting a practical lesson in what exactly that particular theory means. In a nutshell, my zipper reached a temperature of eight-hundred degrees Fahrenheit in about a millisecond. Fortunately, the water was cold and dissipated the heat quickly and effectively. After a minute or two I knew I was safe. Safe but soaking wet. And, when I looked down I saw, to my horror, that the entire front of my jeans was unraveling. The acid, though now relatively dilute, had soaked into the threads where it was doing its best to undress me.



James Wilkes

All's well that ends well—Russ Helfand & his wife, Heidi Bautista, December 1987.

I didn't own a car in college; I took the bus back and forth from my apartment to the labs. I remember dashing out of the building, arms flailing overhead, still fully garbed in my rubber gloves and chest protector (I had flung the facemask aside earlier) and screaming madly as I ran after the bus that was just pulling away from the curb outside. I'll never know why, but the driver stopped and let me aboard. Maybe, on some weird man-to-man level, I was able to communicate my desperate plight through the ethers to him. Anyway, the fifteen-minute ride was a nightmarish vision of my pants dissolving thread by thread, second by second.

But I did, eventually, make it home where I quickly climbed out of my jeans which saved my manhood, which allowed me to ask that cute girl out on Saturday night, which happily led to our marriage five years later. And, though I quit my job at the lab soon thereafter, I didn't quit school. Somehow, I managed to squeak by all my exams and assignments so I could walk away with that coveted sheepskin. I suppose that after surviving the certainty of a dissolved brain, and later, the certainty of a dissolved . . . ummmmm . . . Well, let's just say that exams seemed less terrifying.

STUDENT LIFE IN THE 1990s IN ANN ARBOR AND THE UNIVERSITY

by Lisa T. Keyser, B.S.E. 1998

LIFE at the University of Michigan and in Ann Arbor in general is quite different from what I called “life” in my hometown. The biggest difference is in the people. As a result, the entire atmosphere and activities in Ann Arbor are completely different. To begin, two years ago, when I first moved in to my freshman dorm room, I met students from all over the world as well as those from practically next door. Each with their own hopes, dreams, plans, and beliefs. As I got to know the girls on my floor and fellow students from classes, I began to realize that most of our hopes and dreams were not that different. We all wanted to educate ourselves in order to succeed in our professional, social, and private lives. The way we went about our education, however, was as different as our backgrounds. I chose the path of chemical engineering. Why? I am not quite sure. Yes, my father and brother are engineers, but that is not quite the reason. Yes, I love science and math, but that isn't it either.

I believe I decided that I really wanted to be a chemical engineer in the eleventh grade when, for the first time in my life, I saw the periodic table. Not that I had never seen one before, but for the first time, I actually looked at it and saw the beauty of it. I realized that different atoms are only different by an extra set of protons, neutrons, and electrons. Also, it is possible that there are more elements than we have so far discovered; all we have to do is find a way to add more electrons to other elements. After this discovery, chemical engineering just seemed the right choice to put my interests and talents to use.

The classes I took my freshman year were very general; humanities, writing, computing, etc. Each class was interesting in its own way and also prepared me for the classes I would take in the Chemical Engineering Department. I learned that success in college takes diligent work, organization, and—most importantly—dedication.

In my second year, I officially began my chemical engineering education with *Thermodynamics I*. This class was a fast-pace summary of all science classes I had

taken in my life, as well as an introduction to thermodynamics. I worked on my first open-ended problem (OEP) as well as my second and third. These problems, completed in groups of three or four people, introduced me to the conditions in which I would be expected to work after graduation.



Lisa T. Keyser

Over my sophomore year, I completed at least seven OEPs and learned something new from each. My group would take a seemingly impossible project and turn it into a beautiful, professional report and solution. For these projects, I would be teamed up with friends and strangers; in each case, we would overcome our differences, put our arguments behind us, and achieve our goal. We were taught professionalism through OEPs, both in the planning and development stages, but especially in the final presentation. Each OEP required a professional report complete with abstract and appendices, enclosed in a tidy binder. One may ask what purpose an OEPs has. The answer is simple. It enables us to prepare for “real life” and our future jobs. In fact, a few of my friends have already received jobs because of

the OEPs they have done.

Another educational tool at the university is the computer. This is one thing that forty years ago was practically non-existent, and ten years ago was available but not as useful as today. The amount of tasks a computer can do is absolutely incredible. E-mail was new to me as a freshman, but now I check it everyday, sometimes more. The Internet, the World Wide Web, and net-surfer programs are other modern breakthroughs. They allow me to communicate with people halfway around the world and learn about companies with prospective jobs, all from the comfort of my room; all that is necessary is a computer with a modem. Many classes also employ the computer networks by posting homework assignments, test dates, and quiz answers for all students to access.

Computers have also expanded into other areas of university life. For instance, the first time I went to register for classes, I went to the CRISP (Computer Registration Involving Student Participation) office in the basement of Angell Hall and someone typed in my selections. Now I can dial the CRISP number on the telephone and select my own classes without contacting another person.

Of course, there are events in Ann Arbor other than in the university, and these are the social functions. I am not one who cares much for hard partying, but to occupy my time, I have chosen some academic as well as non-academic activities. The first club I joined at the university was the Ballroom Dancing Club. My primary motivation in joining was so I could dance with my grandfather. After

joining however, I realized there were more benefits to dancing. I was learning social graces and becoming more open with strangers. Both of these qualities are important in class and in the work place—not to mention that dancing is a great stress-reliever.

I also chose to join the American Institute of Chemical Engineers (AIChE). I knew this group would look great on a résumé, but the organization gives so much more to its members. It is a network of chemical engineering students and professionals who are there to help, counsel, and inform new members. This organization has single-handedly answered all my questions or referred me to someone who could. AIChE also sponsors a luncheon that greatly helps members choose which company to work for and who not to work for. Each week, they bring in a professional, who is either a chemical engineer or hires chemical engineers, to speak to us about their jobs. AIChE also offers many social activities for students to get to know each other; the point of this being that when we graduate, our work network will begin with our classmates.



Bill Wood

Hill Auditorium, built in 1913, and undergoing a major renovation (costing about \$35 million) during 2002/2003.

Another thing I love to do is spend time in Ann Arbor away from campus. I do this in order to take a break from the school atmosphere and experience “city” life. My personal favorite place to visit is the Farmer’s Market and surrounding area. It reminds me of my youth when my mom used to bring me here. I don’t usually buy much but I like to smell the crisp fall air and vegetables or the brisk winter air and apple cider. I never tire of this place.

One thing Ann Arbor is famous for is its cultural opportunities such as concerts, performances, and museums. There is so much to see and do that it is nearly impossible to accomplish it all before graduating. Operas are offered in many different languages. Orchestras, from both the university and all over the world perform timeless pieces, at Hill Auditorium and elsewhere. Famous singers and dance troupes are weekly guests in Ann Arbor. As for museums, the university owns rare items from dinosaur bones to original documents from the founding of our great country. The list of things to do and see in Ann Arbor is endless.

Finally, student life isn't student life if you exclude socializing in the dorms. I met all of my good friends in the dorms. We hang out in the halls, eat meals together in the cafeteria, order pizza late at night, and—most importantly—watch movies and TV together. In fact, I met and got to know many of my friends in the TV room. This type of socializing is timeless; the programming and discussion topics may have changed over the years, but I am sure that students have always and will always gather to discuss current issues, backgrounds, family issues, and school topics.

In conclusion, student life is similar to what it was many years ago, and at the same time, completely different. Thermodynamics, fluid mechanics, heat and mass transfer, etc. were taught, still are taught, and will be taught well into the future. Computers, which were non-existent when the chemical engineering department was founded, are practically in every dorm room. Their capabilities are expanding daily; who knows what computers will be used for in ten years? Concerts and performances have been and still are very important at the university. Finally, socializing—the ever-present way to spend time, has, is, and always will be a way for students to meet, become friends and always stay in contact. Some things will never change.

A PERSPECTIVE: GOING THROUGH THE CHE UNDERGRADUATE PROGRAM AT THE U-M IN THE 1990s

by Angela Yeh, B.S.E. 1996

ORIENTATION was two-and-a-half days long, during which you were presented with many tours and an overview of all the options available to you as an undergraduate, namely, the social, the organizational, and the educational opportunities. You also made friends through late-night discussions and euchre games. The most tiring thing about orientation was trying to figure out which classes to take and whether you could get into the courses you wanted. Things are improving in freshman counseling. All freshmen are required to live in the dorms for the first year. I lived in Bursley, a big dorm on North Campus. It was much like the university itself. There was a variety of different people there—different ethnicities and different fields of study and different interests. The dorm was big

enough so that you didn't know everyone there but you got to know very well the people in your hall. Dorm life was a lot of fun, but it was noisy. You could always find someone to do something with you, whether it was work or play. Studying was better done somewhere else. The grad library was a good place to study. The undergrad library was almost as social as the dorm.



James Wilkes

The former “UGLI” has been remodeled and named after a former U–M president, as the Harold T. Shapiro Library. He subsequently proclaimed that he always said it was a beautiful building. July 2000.

Freshman year was fun. There was time to meet a lot of people and time to do your studies and time to get to know the university. After freshman year, I moved out into off-campus housing, changing apartments each year. Living on Central Campus was fun, but you always had to take the bus to class on North Campus. Living off-campus is nice—to have your own bathroom and to learn to deal with household issues.

Socially, there is much to do. There are several movie theaters near campus. There are tons of cafés, often for studying, socializing, or just watching people. One of the newer cafés called “Not Another Café” has live entertainment and a comedy night. There are several museums as well. The very large bookstores,

Border's and Barnes & Noble, are wonderful just to sit in. There are many shops and good food all around campus. At night, there is the Nectarine or Rick's for those 19 and over. The "Necto" is a dance club and Rick's is a bar with cheap drinks and a live band. Ann Arbor is full of bars. The two bars where you will find the most ChemE's are Scorekeepers and Mitch's.



Angela Yeh

For an engineer there is much with which to become involved. There are many opportunities, both on Central and North Campus. All the engineering societies help to make the campus a better place in which there is more opportunity for interaction. It is important to get involved as early as possible. The Society of Women Engineers (SWE) and Tau Beta Pi sponsor the fall Career Fair, which is working to bring more companies to the U-M. Epeians is a leadership honor society that tries to recognize outstanding leadership in the College of Engineering as well as to have societies get to know each other better. The Leadership Recognition Dinner was started this year (1996) to recognize outstanding leaders. LeaderShape is a great way to learn leadership skills and network with leaders around

campus. LeaderShape is an intensive, week-long leadership seminar sponsored by the University of Michigan. A new chemical engineering society started in 1996, and now we have a chapter of Omega Chi Epsilon at the U-M. AIChE continues its tradition of weekly luncheons and corporate speakers. Involvement in a society improves job prospects, because companies are looking for people who get involved with extra-curricular activities as well as with their studies.

The undergraduate chemical engineering program is a good one, packed with many required classes. But there is not much flexibility for taking courses other than engineering and science classes or specialty chemical engineering classes. New educational initiatives are being taken, such as entertaining computer modules to teach basic engineering concepts. Working in groups for open-ended problems teaches teamwork and conflict resolution. Professor Briggs is the academic advisor; he makes sure you are taking all the necessary classes to be on a schedule to graduate. Professors Montgomery, Bike, and Linderman provide a good source for general and academic advice to undergraduates, especially women. The basic chemical engineering laboratory class is modeled as a "real world" company without the technical support found in industry. The classes are challenging. Most of the professors are helpful and good teachers.

The atmosphere is competitive but friendly. It wasn't too difficult to know most of your classmates. It was easier to know fellow classmates in the labs and

smaller discussions. You could always catch chemical engineering students working on the Macs in the Dow Mezzanine computer lab, at any time of the day or night. All students groaned about the same classes, namely ChE 360 (first lab course), ChE 460 (second lab course), and ChE 487 (process design, in which ASPEN—a process-design simulator—was often problematic).



Bill Wood

Looking north on the east side of S. State Street.

Finding a job is usually the main worry of senior year. Some go on to graduate, medical, or law school. The employment market is decent, but you have to work at finding a job. SWE and Tau Beta Pi host a career fair in the fall. Many companies of interest to ChemEs are there to accept résumés. The Engineering Career Center at Stearns provides opportunities for interviewing, although the competition for interview slots is fierce. Many industries hire ChemEs. The semiconductor industry is strong, and ChemE's are hired into companies such as Texas Instruments, Intel, Motorola, and NEC. The petroleum companies are also hiring—Schlumberger, Amoco, Exxon, etc. The chemical and consumer products companies do not hire as many students, but companies such as P&G, 3M, GE, and Abbott recruit strongly at the U–M. Not surprisingly, the companies are often interested in leadership, teamwork, and problem-solving skills, so involvement in societies usually gives a good source of examples. Also, prior experience is usually important. Summer internships are not easy to come by, though they do exist. If one does not get a summer internship, it is usually good to try and do research for a professor for the summer. Most professors have interesting research projects for undergrads to work on, both during summer and the school year.

LIFE AS A WOMAN UNDERGRADUATE

by Bethany Meder, B.S.E. 1996

LIFE as a chemical engineering student has always been demanding, difficult, and ultimately rewarding. However, the life and curriculum of chemical engineering students in the 1990s has been greatly affected by societal, technological, and economic factors. Major changes include the explosion of the number of women studying chemical engineering, the effects of computer usage, and the increased emphasis on problem solving and teamwork.

The changing face of engineering. Traditionally, engineering has been viewed as the domain of Caucasian men. Increasingly, however, engineering students and the engineering work force are growing in diversity, embracing talented women and men of many different races, cultures, and backgrounds. For instance, in 1995, 25% of Michigan's engineering students were female. In chemical engineering, this percentage is even higher, with over one-third of the students being women.



Bethany Meder

This large number of female students helps overcome feelings of isolation, which have traditionally plagued women in technical fields. The addition of female faculty members has also provided role models. As a result, it is common to see women excelling academically in chemical engineering. In fact, many chemical engineering women students have become college and university leaders outside the classroom, participating in student government, honor societies, and professional societies. While women can find personal success in chemical engineering, their presence has also added to the educational experiences of all students. Students cannot go through the chemical engineering curriculum without working with a female team member or having a female professor. This prepares all students for working with others who have different perspectives and backgrounds.

As a female chemical engineering student, I have very rarely encountered anyone who treats me differently because I am a woman. My peers have been respectful and supportive, whether my teams were mostly male or mostly female. Though I am often reminded that engineering is a male world, it has not hindered my ability to learn and thrive at Michigan. I truly believe that the growth of women in our department will strengthen it and broaden its ability to affect our field.

Computers and information. Ask any engineering student today how to use a slide rule and he or she would probably laugh. Why would anyone use a slide

rule when calculators, spreadsheet programs, process simulators, computer-aided design, and even virtual reality are readily available? I have on several occasions discussed with fellow students how engineering was possible before computers; we use computers to do tedious calculations instead of performing them by hand.

In our calculus classes, we learn how to graph, work with matrices, and solve differential equations. However, we saved huge amounts of time in our chemical engineering classes by using Excel to crunch numbers and graph, MATLAB to do matrix calculations, and POLYMATH to solve sets of simultaneous equations. Our senior design project was completely focused around a computer—using ASPEN to simulate pieces of process equipment.

With these time-saving programs also came a huge amount of aggravation. Mysterious errors, broken printers, and crashing computers caused frustration in computer labs at three in the morning. But the ability to do calculations easily allowed us to focus on concepts, the big picture, instead of mind-numbing details. A computer is a chemical engineering student's best friend.



Bill Wood

The Ann and Robert H. Lurie Tower and the Media Union.

Another large impact on engineering life has been the explosion of the Internet and the World Wide Web. E-mail has become a part of everyday life as the most reliable way to reach professors, classmates, and even friends. It is also a welcome distraction during marathon sessions in the computer lab. Searches for information for class or just for fun have been immensely simplified by the introduction of the World Wide Web. Soon, the engineering library will have most journal articles online, eliminating students fighting over the same journal. New information systems have even helped us to find jobs. Students post résumés on the Web or E-mail prospective employers. The Internet and the Web are a part of all of our lives,

both as tools and distractions.

Problem-solving and teamwork. Problem-solving and teamwork are essential tools for a chemical engineer in industry. Increasingly, the chemical engineering curriculum has been focused on developing these skills. Starting from our very first class, problem-solving has been emphasized. Method, rather than exact results, has been rewarded on exams. Problem-solving skills have been enhanced by a new set of computer modules that have been added to classroom lectures. In all classes, group work has been encouraged or even required. Often, teams were assigned, letting us learn how to work with people of very different styles. Most classes included open-ended problems, which challenged us to look for the best answer instead of the “right” one. All graduates of the department have been introduced to critical thinking and communication skills, making us more ready for a future in industry or academia.

Other Parts of Everyday Life

- Construction—as we saw the Media Union, the Lurie Engineering Center, and the Bell Tower being built.
- Buying bagels, donuts, and coffee in the EECS atrium to help us survive class.
- Seeing most of your chemical engineering class in the Dow Mezzanine computing lab all day, every day.
- Going to the bar, especially Mitch’s and Scorekeepers.
- Happy hours at Touchdown.
- Complaining about how the ChE 460 labs have never been finished and that your group was not going to be the first one to do so.
- 1013 Dow, where the large lectures were held, becoming like home.
- Omega Chi Epsilon finally establishes a chapter at Michigan.

INTO THE NEXT MILLENNIUM

by Mayur Valanju, B.S.E. 2000, M.S.E. 2001[†]

I still remember the day before going to the University of Michigan, lying in bed, wondering what it would be like. I was leaving my family and my comfort zone, going to a place with thirty-five thousand different people. Although worried, I

[†] Mayur Subhash Valanju has dedicated this article to the loving memory of his aunt and uncle Bhuvan and Anuradha Pai, who were sadly killed in April 2000 by a semi-truck when only in their forties. Mayur was born in Michigan in 1978 and attended Troy High School. His main hobbies are soccer, racquetball, basketball, and rollerblading. In addition to being president of Tau Beta Pi for 2000, he has been social chair of AIChE from 1998–2000. His numerous U–M College of Engineering awards include the Henry Ford II Prize for 1999 (presented at the end of the junior year to the student with the best academic record) and the Hugh G. Rumler Prize for 2000 (presented to a senior student on the basis of sincerity, integrity, goodwill, and scholarship).

was so excited to explore this new frontier in my life that I spent most of that last night at home just staring at the ceiling instead of sleeping. As I arrived on campus, I found myself not knowing what to do. Classes took up time, but I wanted to expand and enhance other facets of my life through multiple gateways. The first few days of college were full of a many conflicting emotions as I tried to figure out the ins and outs of the university and my way around campus (trying very hard, although unsuccessfully, not to look like a freshman carrying a map and a bus schedule). A couple of days into it, a single event showed me how much this university had to offer to its students.

I was in amazement of an event called “Festifall,” in which all the organizations on campus put up informative displays to try to recruit new members into their organization. I remember seeing, in awe, hundreds of tables that had representatives from every activity and culture in the world. As I walked around, I realized that if I was curious about something, I could learn about it by getting involved in that particular organization. I can definitely link this day with my beginning involvement in different organizations and my beginning as a true student.



Mayur S. Valanju

From then on, freshman year was a blur. I played on the U–M club soccer team, got involved in Future Car, declared chemical engineering as my major, took a couple of exams and the next thing I knew my first semester of college was over. During this semester, I was able to partake in one of the most exhilarating moments in the U–M’s history. I wish everyone could feel the excitement that there was at the end of the season. Walking into the “big house” with more than one-hundred-thousand other fans is an unforgettable experience. I can remember cheering on 22 November 1997 as the University of Michigan finished their undefeated regular season by beating the Ohio State Buckeyes, 20–14. The fans rushed the field and the band played “The Victors” as everybody hugged one another

and slapped each other high five. The players ran back onto the field and celebrated with the fans. It was on to the Rose Bowl for them.

Luckily, I had the privilege of making the trip out to the Rose Bowl. When my friends and I were offered \$1,000 dollars each for a ticket, we had a tough decision to make. We decided to keep the tickets, which ended up being a great decision as I was lucky enough to watch Michigan history unfold as our team finished an undefeated season by beating Washington State, 21–16. That one-thousand dollars would have been nice, but the experience was priceless.

Also during this time, I began to realize the strength and unity of the alumni of

the University of Michigan. It seemed that every time I wore U–M paraphernalia, people would come up to me and say “You go to Michigan, Go Blue” or “Wow, you go to the University of Michigan, that is a great school.” Since I grew up in Michigan, I took for granted having a university of that caliber in the state as a public school. It has taken me my whole college career to realize how respected an institution it is.

In the second semester I realized that there were so many things that I wanted to get out of college and only so many hours in a day. I had to prioritize to see what I really wanted. I decided that my short soccer career was over, and I became more involved in Future Car and a service organization called Alpha Phi Omega. Again, for the second time in a year, we watched a Michigan sports team win a national championship as the hockey team produced a victory. Again, quickly, after a couple of exams, my first year of college was over.



Bob Kalmbach

A familiar picture from the U–M stadium.

During this first year, I had learned a lot about myself. The first year can be a weird time; you can be surrounded by hundreds of people and feel like the loneliest person in the world. Getting involved in organizations was the best way for me to get to know people and to see what I really enjoyed.

My next four years at the U–M went by even quicker than the first, as new friends were made, phone calls to old high-school friends became less and less frequent, self-growth proceeded at an exponential level, and I started to become a true adult. For myself, I got involved in the American Institute of Chemical Engineers, Future Car, and Tau Beta Pi. Through this I learned time management, met many incredible people, and also learned more about myself. Finally, after

graduating with an undergraduate degree, I decided to get my master's degree in chemical engineering at the U-M. From this I experienced the incredible joy of teaching, and realized that I would like to do it again sometime in my life.

Not only is there an unbelievable number of things to do in Ann Arbor, but the buildings that make up the campus are phenomenal. The Michigan Union symbolizes both the past and the present of the university. The change from an all-male building in its early days to a place where the diverse student body holds meetings from all races and genders mirrors the changes in society during the past century. Another building that strikes the fancy of every observer is Angell Hall. Beautiful pillars line the entrance to a building that possesses the biggest computing site on campus. Again this shows the healthy balance of remembering and honoring the past, but always moving towards the future.



Bill Wood

Angell Hall.

I love many things about the University of Michigan. It is diverse in culture and thought, as well as being a leader in education and sports. It is highly ranked in every department, from art to business to engineering. This diversity has allowed me to expand my thoughts by interacting with people from totally different backgrounds going towards different goals. I remember speaking to a friend of mine who spoke passionately about singing and how much it meant to him as well as the rush that he felt doing it. The cultural diversity can be seen in any restau-

rant and classroom. In addition, great programs that numerous cultures put on allow learning and appreciation of the importance of diversity. The University of Michigan provides true education through these pathways.

Throughout my time here, I have fallen in love not only with the school, but also with the city of Ann Arbor. The city has just as much to offer as the university. There are great shops and restaurants with food from around the world on Main Street. One can dance at bars, play pool, or simply relax outside on a beautiful day. There always seems to be an orchestra playing or an *a capella* group singing every weekend. The drummers that frequent the street corners are great to listen to while eating a sandwich and lying on the grass. The “Diag” is always full of people throwing a Frisbee and watching other people. Also, when peacefulness and serenity are desired, the Arboretum provides the beautiful scenery and sounds of nature that let you forget about all your troubles and take a lazy nap. Ann Arbor truly has all that a college student can desire.



Bill Wood

Looking north from the center of the “Diag.”

In addition to the university and Ann Arbor, I have gotten to know many of the faculty and staff of the Department of Chemical Engineering, who have taught me so much. The department provides the wisdom and judgment that comes from some of the experienced faculty, and the excitement and energy that comes from the younger ones. I remember Professor Montgomery speaking at a dinner this past March. She was mentioning an experience that she had with Professor Carnahan at a conference in Arizona. It was a gorgeous day, and Professor Carnahan was skipping out to go and see the Grand Canyon. Professor Montgomery decided to stay inside and staff her booth at the conference. Three people stopped by that

day, and she still has never seen the Grand Canyon till this day. I took a lot from that speech, as I realized then that although it is important to work hard, it is equally important to take time to be spontaneous and have fun with life.

I also see the department progress through the last five years as it evolves with the technological explosion. Up until recently, teaching has been done by writing notes on a blackboard or by describing concepts on an overhead projector. Now, with the Internet commonplace and virtual reality right around the corner, professors are starting to take advantage of alternative channels of teaching. Home pages provide administrative information to allow the professors to spend more time teaching, and multimedia is allowing great tools to help the students see what reactors and plants look like as well as visualize the concepts that they are learning. Also, through open-ended problems, the department has really begun addressing these needs.



James Wilkes

North Campus from the Arboretum, November 1960.

Presently, this country has really found itself in a situation that it has never seen before. There has been economic expansion with relative peace for the last eight years. Because much of this growth has come on the technological side, engineering graduates from the University of Michigan are finding themselves having multiple job offers in hand with high starting salaries and plentiful benefits. The technological expansion can be seen by the growth of the College of Engineering during my five years at this school. The Media Union, Reflection Pool, Lurie Engineering Building, Wilson Student Project Center, and the Lurie Tower were all opened up during these past five years.

I believe that the technological explosion will continue to occur well into this

new century. Engineers will have the ability to alter humans genetically, create new transportation methods, and send people into space for a vacation. With a greater reliance on technology, the engineering degree of the twenty-first century might be the literature, science, and arts degree of the twentieth century. Some of the consequences of the technological outbursts will be a greater separation between countries economically. Countries that do not currently have a technological infrastructure will not be able to participate in this productivity increase and further development. This further separation between countries will make it continuously harder for other countries to participate effectively in world trade.



Paul Jaronski

North Campus fountains and the Ann & Robert H. Lurie Tower.

As a U–M engineer, I feel that it is necessary always to remember the power that we have as engineers. We have the ability to help people that do not have the skills necessary to advance themselves. During my stay at Michigan, I have seen the number of service-oriented projects increase dramatically. Senior design projects are focusing on helping members of the community, as students with their engineering skills have designed and built extendable wheelchairs and ramps for the handicapped youth, playground sets for younger students, and much, much more. From these events, I believe that Michigan engineers are on the right track to stay very humane while being leaders on the cutting edge of technology and growth.

For the year 2000, it was my good fortune to have been elected as president of Tau Beta Pi at the U–M, an interdisciplinary engineering honor society that offers recognition to students who show high scholastic ability and exemplary character.

The Michigan Gamma Chapter, the third-largest chapter in the country, strives to provide service to the community. Over the years, chapter members have participated in events such as Habitat for Humanity, volunteered at Mott's Children's Hospital, and provided tutoring for undergraduates.

Over the past three to four years, Tau Beta Pi has experienced rapid expansion in organizational structure and in the amount of activities it has sponsored. The Career Fair, co-sponsored with the Society of Women Engineers, is now a two-day event that involves more than three-hundred companies across the country. Along with that, the number of officer positions available has increased to twenty; also, over forty different leadership positions are available. With these expansions, Tau Beta Pi will continue to enhance the leadership ability of many people as well as serve better the College of Engineering and the community at large.

1999C³: THE AIChE NATIONAL CHEM-E-CAR COMPETITION



James Wilkes

Chemical engineering undergraduates Robert Doty and David Wojciechowski with the winning Michigan car.

IN November 1999, the first annual chemical engineering model-car race was held at the National AIChE meeting in Dallas. The object of the competition was to design and build an autonomous vehicle powered by a chemical reaction that would:

1. Fit inside a shoebox.
2. Carry a specified amount of water, between 0–500 ml.
3. Travel a specified distance, between 60 and 100 feet, and then stop.

The requirements in Items 2 and 3 were announced an hour before the start of the competition. The race was inspired by Prof. Scott Fogler, who had introduced a similar competition for groups in his undergraduate *Reaction Engineering and Design* course at the University of Michigan during winter 1999.

Five teams entered the competition in Dallas: the University of Nevada at Reno, the University of Iowa, Washington State University, Florida Tech, and the University of Michigan. The event consisted of two parts:

1. A poster competition.
2. The car race.

After the poster competition, the Michigan team, spearheaded by Robert Doty and David Wojciechowski, and also including Chris Horvath, Matthew Robertson, and Shirley Martaniardjo, was in third place. Then, with a large crowd in attendance, the race began. The cars were powered by different mechanisms: two used fuel cells, one employed the reaction of Alka-Seltzer and water to complete an electrical circuit connected to a motor, one used a model rocket engine, and Michigan's car was jet-propelled by a controlled release of the gas produced in the reaction between 50 ml of 31.5% hydrochloric acid and a pre-determined amount of baking soda, placed in two 20-ounce soft-drink bottles.

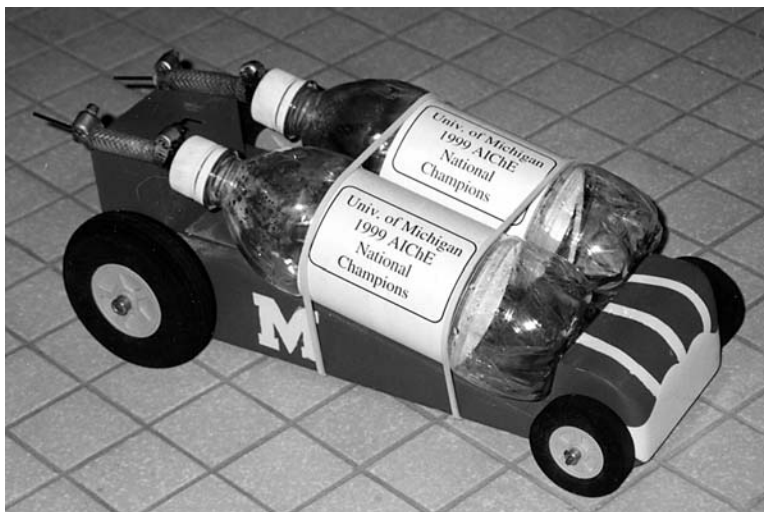

James Wilkes

Close-up of the Michigan car.

Each team was allowed two runs at the specified distance of 75 feet, carrying 300 ml of water, and the better result was taken from these two runs. After the first run, the Michigan car had performed the best and appeared to have the competition well in hand. During the second run, however, the Nevada/Reno car stopped within a few inches of the mark and looked unbeatable. The Michigan team then followed, carefully consulting their calibration data and making final

adjustments based on the first run and also for the fact that the competition had suddenly been moved indoors after announcing that it was to be run on asphalt. Rob and David carefully measured out 3.6 teaspoons of baking soda (temporarily isolated in Saran wrap) into each bottle. The two plastic tubes leading to the basketball-pump needle nozzles were clamped shut with locking pliers and the bottles shaken, generating a pressure somewhat above 100 psi, but well below the safe limit of some 250 psi.

Upon the signal, the locking pliers were quickly released, and the Michigan car started on its way. When it finally stopped, it straddled the finish line, and the front was about an inch from the line! This performance was unmatched by the remaining cars, and the Michigan team prevailed! Our win was all the more remarkable because the total cost of our car was \$30.40, whereas the other four entries were much closer to the limit of \$500.

THE HELEN B. GIBSON SCHOLARSHIPS

William M. Gibson. A very good friend of the department, Mr. William M. Gibson, has endowed a fund that enables us to award annually two or three undergraduate scholarships in memory of his late wife, Helen B. Gibson. The recipients are selected on the basis of a good academic record, financial need, extra-curricular activities, and—most importantly—demonstrated outside work in order to help pay their way through college.



Cheryl Scheideman, 1997



Matthew Cranston, 1998



Justin McCabe, 1998

This gift is a token of Mr. Gibson's lifelong belief in the value of a good education. He himself was born in 1904, the seventh of eight children, on a farm near Independence, Missouri. He was able to attend high school only by moving in with his oldest brother, whose farm was somewhat closer to the Independence High School. In the middle 1920s he studied chemical engineering at the University of

Missouri at Columbia, where he was a member of the football and wrestling teams, and of the Triangle fraternity. His wife of 66 years, Helen, was also a student at Missouri/Columbia, and at first she was unable to graduate when her marriage was discovered—until then, women known to be married were not allowed to enroll! She made history by causing the *Regents' Bylaws* to be rewritten and she became the first married woman student to graduate at Missouri/Columbia.



Daria Gawronska, 1999



Nathan Hoffman, 1999



Kathrina Konopka, 2000



Arkadiusz Podsiadlo, 2000



Prerna Chaudhry, 2001



Tim Johnson, 2001

William Gibson's professional work was spent in the paint and varnish industry in the Midwest, and he retired as president of Berry Brothers Paint Company in Detroit in 1963. He and his wife had lived in Grosse Pointe for several years before retiring in 1965 to Aiken, South Carolina and—more recently—to Augusta, Georgia. His hobbies included wood-working, growing roses and vegetables, and reading (Rudyard Kipling and Mark Twain were favorites). He died in October 2001, just short of his 98th birthday.



Derek Bagozzi, 2002



Michael Burns, 2002

Mr. Gibson had two daughters, Mary Ann Gibson Wilkes and Elaine Gibson, and was the father-in-law of one of our faculty members, Jim Wilkes.



Helen and William Gibson, Detroit, 1938.

Recipients of the Helen B. Gibson scholarships. The accompanying photographs show the student recipients of the Gibson scholarships; the date indicates the beginning of the academic year in which the scholarships were held.

Reminiscences of Helen Gibson. At the Engineering College Honors and Awards Luncheon in the Michigan League Ballroom in November 2000, Mary Ann Gibson Wilkes was one of the two speakers:

If my mother, Helen Gibson, were alive today (she died a few years ago over the age of 90), she would probably be both terribly embarrassed and secretly quite pleased to see me here. In the autumn of 1929 (I think all of you know—even if only at second-hand—what occurred then), my mother had just begun her senior year at the University of Missouri. She was almost 25 years old, having deferred her admission in order to live at home and work full-time to save money. She also worked at least half-time during the academic year. As 1930 approached, money and jobs grew scarcer. And my mother realized that she couldn't afford to complete her senior year. (Tuition at a state school then seems almost laughably low by today's standards, but there were no National Merit Scholarships or student loans either.) Her roommate's father—a Mr. Sonnenschein—somehow learned of her plans to leave school. I don't know if Mr. Sonnenschein was a wealthy man or not, but he must have been a prudent investor. His immediate reaction was, "Helen, you can't leave school! I'll be glad to lend you \$500." I don't know what \$500 would be in today's dollars, but conservatively anywhere from \$5,000–\$10,000. My mother thanked him for his generous offer, but said she could not accept: "There's no way I'll ever be able to repay you, Mr. Sonnenschein." His reply was, "Helen, I don't expect you to repay *me*. But, one day, you will be in a position to help someone else in similar circumstances."

My mother told me this story only once—almost 60 years ago. It has never left me. I learned only last week that she had never told anyone else—not even my only sibling. In choosing the recipients of the scholarship, my husband and I give strong weight to those who—like my mother—are working significant hours outside their studies to finance their education. And now we come full circle. In just over three years, we have already had seven excellent and worthy recipients of the Helen B. Gibson Scholarship. Obviously, Mr. Sonnenschein was a very good investor!

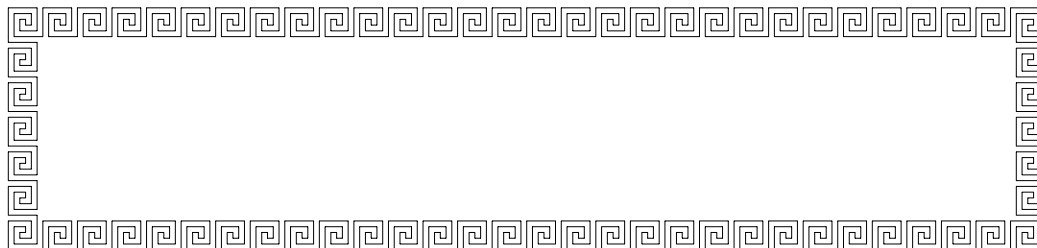

THE JAMES O. WILKES SCHOLARSHIPS



Paul Jaronski

Mary Ann and Jim Wilkes

JIM Wilkes retired in May 2000, after 40 very satisfying years in the department, and a retirement recognition dinner was held for him on October 7th in the Vandenberg Room of the Michigan League. It was attended by more than 100 friends and colleagues, ten of whom spoke wittily about Jim's career—Wayne Jones (master of ceremonies and associate dean of undergraduate education), Brice Carnahan, Donald Nicklin (Jim's first Ph.D. student, who had traveled from his native Australia for the occasion), Stuart W. Churchill (Jim's doctoral advisor), Ma-

rilyn Mason (chairman, U–M Organ Department), John C. Ulicny (12th doctoral student), Elizabeth Batesole Hainey (19th doctoral student), Duc Anh Nguyen (graduate student from Chulalongkorn University, Bangkok), Gertrude V. Huebner (U–M regent emerita), and Brymer Williams.



J. Wayne Jones
Master of Ceremonies



Brice Carnahan
Univ. of Michigan



Donald J. Nicklin
Univ. of Queensland

Before the dinner, a social hour was generously hosted by Brice Carnahan at his home, and the Wilkes held an open house after the dinner. The department also established an undergraduate scholarship endowment fund in Jim's honor, only the second time in 102 years that they had done so for a living faculty member.



Stuart W. Churchill
Univ. of Pennsylvania



Marilyn Mason
U-M University Organist



John C. Ulicny
PhD, Univ. of Michigan



Elizabeth Batesole Hainey
PhD, Univ. of Michigan



Duc Anh Nguyen
Chulalongkorn University



Gertrude V. Huebner
U-M Regent Emerita



Brymer Williams
Univ. of Michigan

Thanks to the generosity of some 200 donors, the fund is already close to \$100,000, the income from which will provide two or three annual scholarships for undergraduates who are working to support their own college expenses and who are helping their fellow students by significant extra-curricular activities.



Paul Jaronski

Some of Jim Wilkes's doctoral students, with their dissertation years: Kevin Ellwood (1991), Rick Blunk (1996), John Ulicny (1981), Elizabeth Batesole Hainey (1993), Jim Wilkes (1963), Rosemarie Wesson Williams (1988), Clifton Goddin (1965), Joe Greene (1993), Don Nicklin (1961); Michigan League, 7 Oct. 2000.



Mary Ann Wilkes

Brice Carnahan, Jim Wilkes (home at his post-retirement party), Debbie Lenz, Jim Rennell, 2 AM, 8 October 2000.

The First James O. Wilkes Scholarship Recipients

Michelle Arthur (2001)



Michelle was on her Troy, Michigan, high-school lacrosse team, and graduated from the U–M in May 2002. After working an additional 40 hours/week (for one year as a bartender) to pay her own way through school, the scholarship enabled her to switch to a 25-hour/week position as an engineer at an automotive supply test lab during her senior year. Michelle is fluent in both French and German. Her hobbies include running, snowboarding, kickboxing (Thai style), and playing the piano and saxophone. After working with Eli Lilly in summer 2002, Michelle will continue for a U–M master’s degree in pharmaceutical engineering.

Tim Johnson (2002)



A transfer-student from Albion College, Tim Johnson’s hometown is White Lake, Michigan. After graduating in December 2002 with bachelor’s degrees from both Albion and Michigan, he will enter employment with General Mills in Minneapolis. During winter 2002, he worked at two jobs to help finance his college education: 15 hours/week as a building supervisor in the U–M North Campus Recreation Building and 20 hours/week as a resident advisor in Baits Housing. For the last three years, he has coached the Commerce Township Little League baseball team at weekends. Tim is also a certified lifeguard.

Claire Felczak (2002)



Claire started her college career at Texas Wesleyan University in Fort Worth, Texas, before coming to live in Westland, Michigan, transferring first to the Henry Ford Community College and then to the U–M. Claire helps to support her college education by working about 20 hours every weekend as a server, cook, and cashier at the Macaroni Grill in Livonia, Michigan. During summer 2002, she has an internship with BASF in Ludwigshafen, Germany. Claire will graduate in May 2003. She is active in her family events and the AIChE, and plays tennis and the piano.

THE JANE AND HOWARD TENBROECK SCHOLARSHIP

ONE of our undergraduate scholarship funds was endowed in 1992 by Jane TenBroeck, and named after herself and her late husband, Howard, who had died in 1983. Jane, née Furlotte, was raised in Troy, Michigan, and both she and her twin sister graduated in 1940 with degrees in elementary education from Michigan Normal College (now Eastern Michigan University). Jane taught school in Macomb County until she married Howard TenBroeck in 1943 and moved to New York City, where Howard worked at the Mobil Oil Company Brooklyn Refinery. Previously, Howard had graduated in 1937 with an M.S.E. in chemical engineering from the University of Michigan. His career with Mobil eventually led to their Manhattan headquarters and subsequently to their offices in Princeton, New Jersey.



Jane and Howard TenBroeck, 1944



Jane TenBroeck, 1990

In 1984, Jane moved to Ann Arbor and was a frequent guest at the annual Donald L. Katz Lectureship dinners until her death in 2000. The TenBroecks had two daughters, Martha and Alice. Martha and her husband Paul Bhatia also now attend the DLK dinners. We are grateful for the Jane and Howard TenBroeck scholarship, which is awarded annually to a deserving chemical engineering student.



GRADUATION IS FUN!

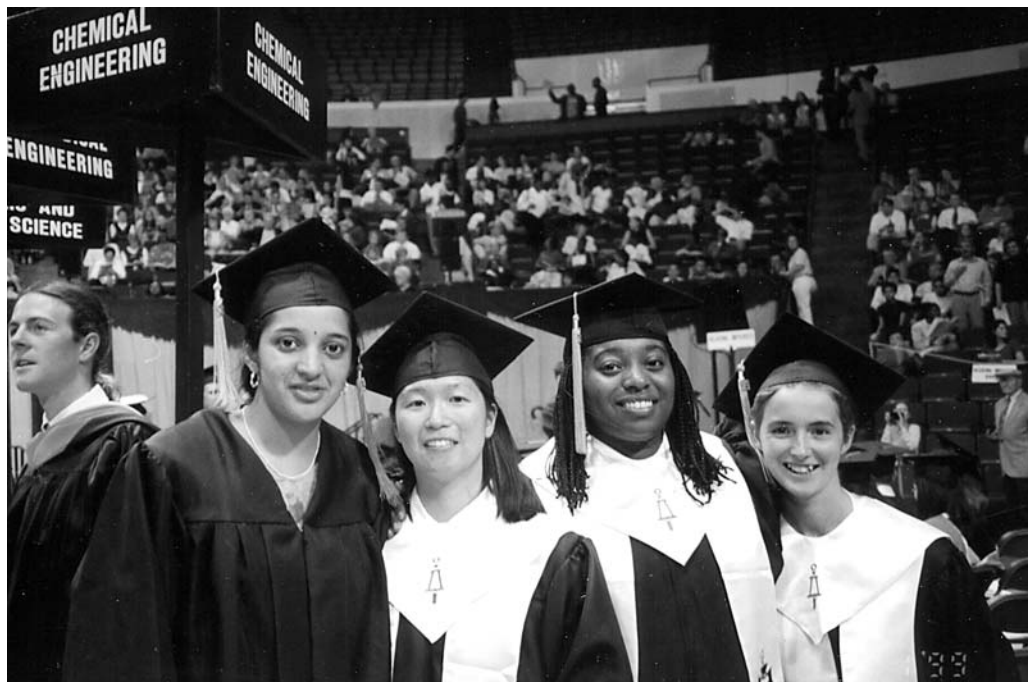

Sandra Swisher

Aishwarya Rengan, Benita Kuo, LaRuth McAfee, and Kelly Ries, graduation in Crisler Arena, April 1999.



Sandra Swisher

Some members of the ChE class graduating in May 2001. Podbielniak Lounge.



Sandra Swisher

Some members of the ChE December 2001 graduating class. Podbielniak Lounge.



Sandra Swisher

Mark Staples & Tamika Young at their graduation, 27 April 2002.

The following page shows graduating seniors on 15 April 2002, after a reception held for them in the Podbielniak Reading Lounge. Photograph by Sandra Swisher.



Outside the Herbert H. Dow Building



Sandra Swisher

Alice Chou, Hannah Murray, Jessica Motyl, Melissa Salloum, and Kelly Alstead. After the pre-graduation reception, 15 April 2002.



Sandra Swisher

Ken Chomistek, Dru Dunham, Angelo Sutor, and Jose Azurdia. After the pre-graduation reception, 15 April 2002.

Chapter 16

CHULALONGKORN UNIVERSITY—THE PETROLEUM AND PETROCHEMICAL COLLEGE

U–M Faculty Teaches ChE & Macromolecular Sciences in Bangkok†

THE University of Michigan has many international programs and exchange agreements with universities all over the world; however, the Chemical Engineering Department has spearheaded one of the most successful of these programs.



The Petroleum and Petrochemical College, Chulalongkorn University.

Since 1993, the Petroleum and Petrochemical College (“PPC”) at Chulalongkorn University, Bangkok, Thailand, has developed international master’s degree programs in petrochemical technology and polymer science. These programs resulted from a USAID‡ catalyzed (and partially funded) collaboration between PPC and three departments in the United States: Chemical Engineering at the U–M, Macromolecular Science at Case Western Reserve University, and Chemical

† A first draft of this chapter was prepared by Prof. Erdogan Gulari.

‡ United States Agency for International Development.

Engineering and Materials Science at the University of Oklahoma. In 1998 the program successfully completed its fifth year of existence by awarding fifty M.S. degrees, split evenly between petrochemical technology and polymer science. For the first seven graduating classes (1995–2001), the program has awarded 320 master's degrees to its students, making it by far the largest M.S. graduate program in Thailand. The participation of the Michigan Chemical Engineering Department is largely due to the foresight and vision of Professor Schwank who—as the department chair in 1992—laid the groundwork and contributed substantially to the initial USAID proposal, which was instrumental in starting the program.



1999 PPC graduating petrochemical technology class (which entered in 1997).

In the early years of the program, the Petroleum and Petrochemical College essentially provided the facilities and the students, and the three participating departments provided the faculty, who taught over 80% of the courses in an intensive one-month one-course-at-a-time format. More recently, newly appointed Thai faculty have been sharing more of the teaching responsibilities with the U.S. visiting faculty. The 50 or so contact hours for each course are somewhat more than those in a regular full-semester three-credit-hour course at Michigan. Every year, three or four faculty from the U–M Chemical Engineering and Materials Science & Engineering Departments go to teach in Bangkok. So far, professors Brice Carnahan, Scott Fogler, Erdogan Gulari, Ronald Larson, Johannes Schwank, and James Wilkes of ChE, and David Martin and Richard Laine of MSE have taught month-long courses. Professor Fogler has also taught several short courses and Professor Yang has advised students and made research presentations. In addition to their teaching responsibility, the faculty shoulder the co-advising of the graduate

students' research projects for their masters' degree theses.



A representative group of Thai students during a break from the “poster” presentations of their research projects.

Teaching in Bangkok is very hard work, and advising students who are 10,000 miles away is very demanding (and frustrating at times). Communication is mostly over the Internet. However, the main attraction for the faculty who participate in this program has been the desire of the students to learn and their respect for their teachers.



Advanced fluid mechanics class, December 2000.

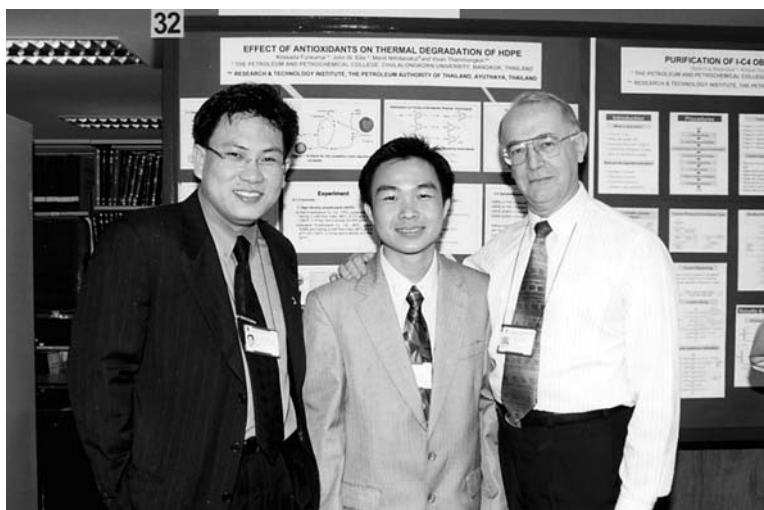

Poster presentation of Mr. Kridsida Funkumai (center), with co-advisors Dr. Manit Nithitanakul (L) and Mr. John Ellis (R), 27 April 2000.

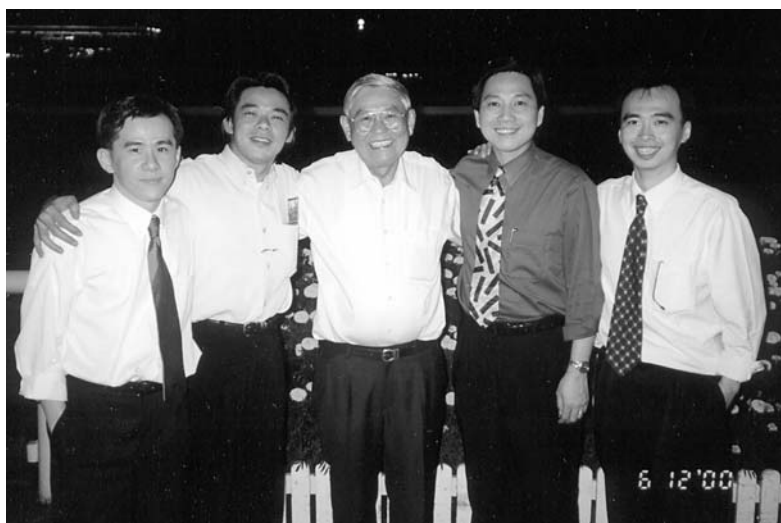

James Wilkes

Prof. Kamchad Mongkolkul hosts junior faculty at the Royal Bangkok Sports Club. Asst. Prof. Pramoch Rangsunvigit, Asst. Prof. Suwabun Chirachanchai, Prof. Kamchad, Dr. Pomthong Malakul Na Ayudhaya, and Dr. Boonyarach Kitiyanan; 6 December 2000.

Michigan faculty are traditional favorites of the Thai students. Professors Fogler, Gulari, Schwank, and Wilkes have been particularly popular as teachers and research advisors by the PPC students. Each U–M faculty member typically advises a few or several students from each class and many of the students come to Ann Arbor for visits of a few weeks or months to work with their advisors and complete the writing of their dissertations. So far, we have had approximately 50 students from the Chulalongkorn program come and visit our department.

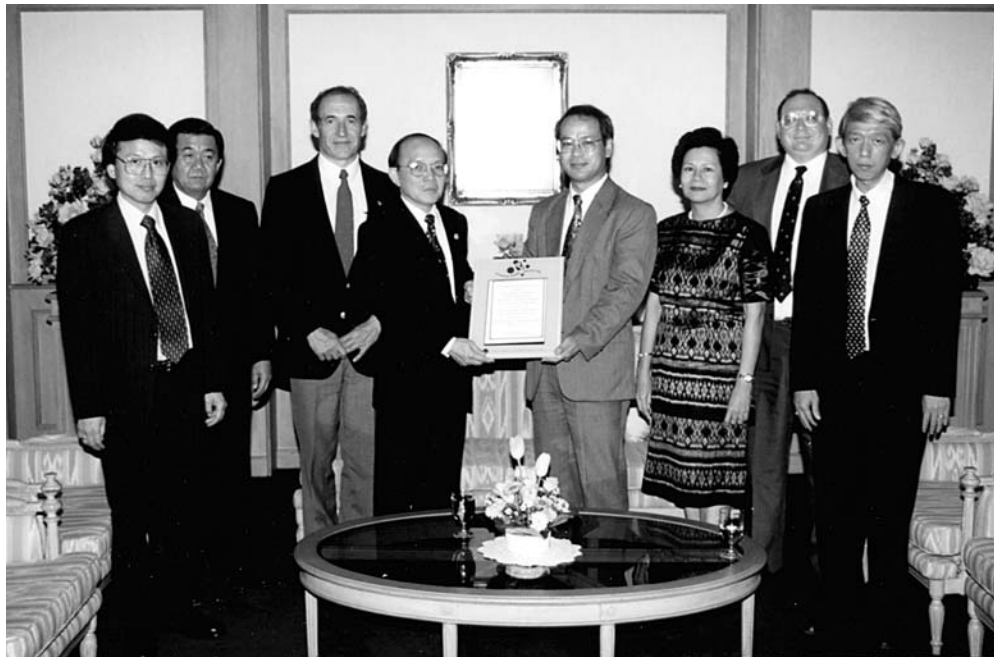

A presentation in 1999 by Prof. Ishida of Case Western Reserve University on behalf of the American Chemical Society, to recognize the PPC polymer science program. Prof. Sumaeth, Prof. Somchai (director, PPC), Prof. Gulari, Prof. Ishida, Dr. Thienchay Kiranandana (president of Chulalongkorn University), Prof. Kunchana, Prof. Scamehorn (Univ. of Oklahoma), and Prof. Lursuang.

The graduates of the PPC program have been sought heavily by the multinational companies doing business in Thailand; so far, the main employers have been the new refineries built by Shell, Caltex, and Esso. Other multinationals that have employed the graduates of the program are Dow, Lam Research, Gateway, IBM, Degussa, International Colloids, National Starch, and a variety of Thailand-based petrochemical companies.

A side benefit of the program is the several excellent Thai Ph.D. students we attract to Michigan as a result of their increased awareness of our department. The majority of these students receive Thai government fellowships.

The Petroleum and Petrochemical College and Its Directors†



James Wilkes

Professor Kamchad Mongkolkul, PPC Director, 1989–1993

Chulalongkorn University was founded in 1916, being the first university in Thailand. Since then, it has grown steadily and remains the country's most prestigious university. Today it has eighteen faculties, two graduate schools, three colleges, eleven research institutes, two centers, and three affiliated institutions. Chulalongkorn University graduates number about 6,000 students each year, with degrees ranging from bachelor to doctorate. The university set up the Petroleum and Petrochemical College in 1988, in anticipation of the need for highly qualified manpower in the newly established and fast-growing petrochemical and petroleum industries. The new college aimed to develop into a center of excellence in petrochemical technology and polymer science. To achieve this aim the college entered into an academic partnership with three leading U.S. universities and began offering international graduate programs in 1993. Today, "PPC" has become the largest and best-equipped graduate school in its field.



Prof. Somchai Osuwan, PPC Director, 1993–2000.

† Excerpted from the Petroleum and Petrochemical College, Chulalongkorn University, *Activity Report 2000*.

The Petroleum and Petrochemical College is one of the few graduate schools in Chulalongkorn University that have their own governing body and a certain degree of autonomy. This structure has enabled the college to overcome some of the limitations of the traditional government system and to operate more independently, while remaining a government institution. The governing body of the college consists of a Governing Board, chaired by the president of the university and meeting once or twice a year, and an Executive Board, chaired by the director of the college and meeting bimonthly. The college receives regular annual budget support from the government. The extra expenditures arising from the international program are covered by income from student fees, industrial service charges, short-course fees, research grants, and donations. The structure of the college consists of three main departments—administration, academic affairs, and research affairs. In 2000, the Petroleum and Petrochemical College had 16 full-time faculty members, 32 administrative and technical staff, and an expatriate who worked as a technical specialist.



Prof. Kunchana Bunyakiat, PPC Director, 2000–

The college is now thriving, despite the end of USAID funding in 1996 and the severe economic crisis in the late 1990s. This happy state of affairs is a tribute to the original vision of Prof. Kamchad Mongkolkul, to the dedication of the second director, Prof. Somchai Osuwan, who had the critical task of leading the college for several years from the “vision” stage, to the solid support of the higher administration of Chulalongkorn University, to the students and staff of the college, and to the leaders of Thailand’s industry. The college and its programs have come a long way since the start of the first class in 1993. The student body and the faculty have both grown significantly, the curricula have stabilized, the facilities of the college are mostly complete and are in some cases better than those of the partner U.S. schools. Since October 2000, PPC has been under the able leadership of its third director, Prof. Kunchana Bunyakiat.

The last nine years, 1993–2002, have provided a learning experience for all of us—how to teach intensive one-month courses effectively, how to organize research with a joint advisee and co-advisor communicating mainly by E-mail, and how to organize our research projects so that something of mutual benefit can be achieved. One of the major learning experiences was the realization that a first-rate Ph.D.

program was essential for the long-term health of the master's programs of the college. It was very gratifying for all of the U.S. faculty that the Ph.D. program was approved in 1997 and that three years later there were 31 candidates in the program. The college graduated its first Ph.D. student in 2001, a great way to start a new century and to recognize the dedicated effort of a large number of people. Now, nine years after it started classes, the Petroleum and Petrochemical College has become the best graduate program in Thailand and indeed in all of Southeast Asia in the fields of chemical engineering and polymer science.

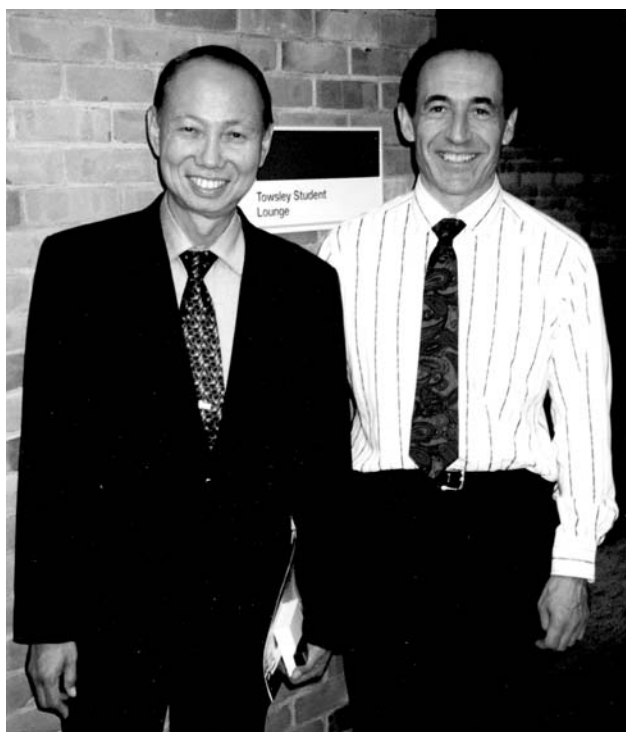

Ieum Ieumwananonthachai, a good friend of the PPC and a leader in the Thailand chemical industry, with Erdogan Gulari, Ann Arbor, 1995.

The college occupies eight floors of a 14-story building located in the north corner of the university campus. Its total floor area is 7,000 square meters, which is divided into six laboratories, a library, a computer center, a 120-seat auditorium, classrooms, and offices for the faculty, graduate students, and the administration.

The U-M Chemical Engineering Department can be proud of its pivotal role in the success of this program and much of the credit must go to Professor Johannes Schwank who, as chairman, had the vision to see the potential of this type of mutually beneficial collaboration.

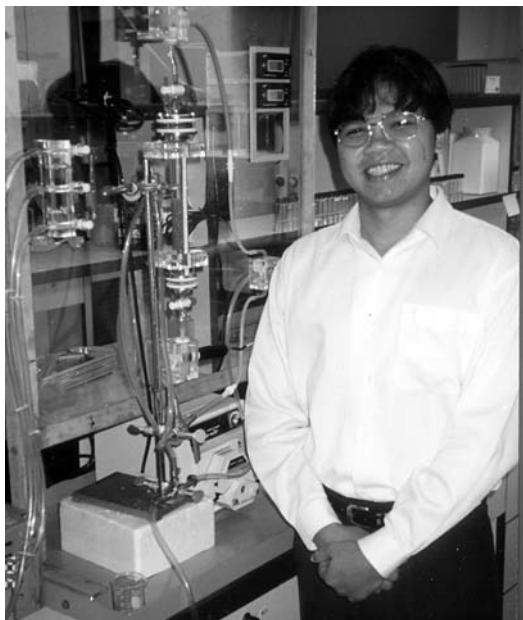

James Wilkes

PPC second-year master's student Manat Manantapong, working on cation ion-exchange in a fluidized bed, July 1996.



James Wilkes

University of Michigan doctoral student Piyarat Wattana ("Ann") with a plate of dessert at a U-M Thai cultural afternoon, March 1998.



June 1997 at Somboon's restaurant. Veerapat Tanta-yakom ("Five"), Sumate Charoenchaidet ("Jew"), Prof. Scott Fogler, Napaporn Komesvarakul ("Cheng"), Itti-porn Suwunnamek ("Pong"), and Settawat Takulpakdee-choumpon ("Koong").



Many delicious Thai fruits—langsad (upper left), mangosteen (dark, with two half-peeled near bottom), lychee (upper right center) rambutan (hairy), and cyder (strawberry shaped, with three peeled segments to right).

Chapter 17

THE CHEMICAL ENGINEERING STAFF



"University Record," June 1958

Four of the machinists and instrument makers of the Chemical and Metallurgical Engineering Department are shown above. At the top is Frank B. Drogosz, instrument maker, busy with a repair job. Below, left, are welders William E. Hines and Cleatis Bolen, while at right is machinist Ludwig K. Eppler, who retired this month (June 1958).

SOME FORMER STAFF MEMBERS

OVER the years, the department has been fortunate to have had many excellent secretarial and technical staff members, several of whom are recalled in this chapter. Further recollections are given by Brymer Williams in Chapter 21, particularly of a few personalities not detailed here—Thelma Dyer, Erwin Muehlig, Elmer Darling, and John Wurster.

The period before our move to North Campus represented the heyday of our technical workshop staff. After then, the College of Engineering went largely to a centralized system, which made some sense from a cost viewpoint, but removed much of the camaraderie that had previously existed. The workshop staff members in East Engineering during the 1960s and 1970s are particularly memorable, and included Cleatis Bolen (manager and general factotum), Doug Connell (welding), Elmer Darling (electrical), Frank Drogosz (instruments), Bill Hines (stockroom), Erwin Muehlig (stockroom), Peter Severn (glassblowing), and John Wurster (machine shop). In addition to being skilled at their trades, the workshop staff had very friendly personalities and were generally inspiring “characters.”

Cleatis Bolen



Courtesy Novella Bolen

Surely, few people will dispute that Cleatis Bolen—“Fanny” to almost everybody—was one of the leading characters in the history of the department. He was born November 27, 1915 in Wolf Lake, IL, the son of Millard and Cora (Foster) Bolen.† His habits of hard work began as a child when he worked on his parents’ farm in Wolf Lake—and later Cairo. At the age of 15 he joined the Illinois National Guard, and when war began served stateside in Alabama, California, Washington State, and Hawaii, ultimately fighting in the South Pacific. After his discharge in 1945, Bolen rejoined his wife (whom he had married in 1940) in Ann Arbor and began looking for work. An ad in the paper led to a job at the University of Michigan. “They were looking for a welder and machinist,” Fanny recalled, “and truthfully I hadn’t had experience in either field. But I was a good worker—I always prided myself on that.” U–M hired him on the proviso that he completed training in welding, so for six months Bolen worked at the Hobart Welding Company, completing a weekly trek from Ann Arbor to Troy, Ohio. In 1946 he began work at U–M as a maintenance mechanic, earning 85 cents an hour to start.

† Taken partly from *The Ann Arbor News*, 13 May 1996.

Fanny was employed with the U–M for 35 years, retiring in April 1981 as machinist and manager of the workshop staff. His official title for many years was Supervisor of Technical Service for Chemical and Metallurgical Engineering. Fanny was a friend to everyone, an inspiring leader, always ready to lend a hand and render technical advice. No beating around the bush with him—if he didn’t agree with something, he would tell you and explain his viewpoint quite clearly and respectfully.

Fanny was a life member of Golden Rule Lodge #159 F&AM, and a member of Disabled American Veterans. He died at the age of 80 on Sunday, May 12, 1996 at St. Joseph Mercy Hospital in Ann Arbor. Survivors included his wife, Novella D. (English); a sister, Virginia Cain of St. Petersburg, FL; one nephew, Michael Cain of Chesapeake, VA; and a niece, Patricia Wilks of Forest Hills, NY.



Dale Briggs and “Fanny” Bolen, at the latter’s retirement dinner, Michigan League, 28 April 1981.

Fanny possessed a genius for tools, and had as much ingenuity and engineering “know-how” as a degreed engineer, although his efforts toward that goal were thwarted by active duty in World War II. With his hard work and mechanical skills, Bolen quickly established himself as the mainstay of the department’s workshop staff. But he is also remembered as an all-around great human being who was good friends with virtually everybody. He had a fine sense of humor, spoke directly and to the point, and was a great judge of human character. His “people skills” included the ability to work well with graduate students, helping them make their incipient designs a reality. “When I welded, I built equipment for students who were getting their Ph.D.s,” he said. “I built evaporators, filters, those kinds of things. Sometimes they’d give me the specs, but sometimes I’d just stand there and listen, and kind of draw it out of them.”

Fanny recalled the days of the fearsome G.G. Brown: “There was a running battle between Brown and George Foster, my supervisor. Sometimes Foster would stand in the hallway smoking, where he wasn’t supposed to—but if he saw G.G. Brown coming down the hall, he’d snuff it out right away!”



James Wilkes

John Wurster and “Fanny” Bolen with his ubiquitous tool cart, at the latter’s retirement dinner, Michigan League, 28 April 1981.

Bolen credited the department with promoting a feeling of camaraderie and allowing him to develop his skills and abilities to the fullest. “I was able to do anything, because of the great team we had,” he once said. “For example, we were always blessed with good electricians, so if I needed advice on an electrical problem I could always ask them. People really helped each other.” For many years, he kept a weekly Friday lunch date with Brymer Williams, Ed Young, Pete Severn, Bob Kadlec, and other friends, at various restaurants in Ann Arbor—a tradition that still exists in 2002.

Although he retired in 1981, Fanny continued with the woodworking, refinishing, wiring, building, and plumbing work that earned him additional praise from faculty, staff, and students. His West Side Ann Arbor home was studded with mementos from his lifetime of service in the department. Among them was a finely crafted grandfather clock he had assembled from pieces found in G.G. Brown’s laboratory. “The clockworks were just lying in pieces all over the lab bench,” Fanny once said. “One day I finally asked G.G. Brown if I could have them. He said okay, so I took the pieces home and put it all together.”

We have many fond memories of Fanny, not only at work but also at the graduate student picnics, where he presided over the large grill (made in our workshops)

and indulged in the occasional poker game. His accomplishments were recognized in April 1981 at a dinner in the Michigan League, attended by a large gathering of friends and colleagues. Fanny summed up his life at U–M in his characteristically straightforward way: “It’s been a wonderful place to work, and a very enjoyable 35 years,” he said with a smile. “I’ve got no regrets.”

Cynthia Miller



Cynthia Miller came to the department in 1982 and, most recently, was working as an administrative assistant. She was a friend to many faculty, staff, and present and former students, and was a dedicated employee who routinely went above and beyond what was required of her. Cynthia was usually the first person to arrive in the morning. She always said she liked those early morning hours because she could concentrate better before others came in. It wasn’t unusual to see her in the office during the weekend, catching up with work left over from a busy week and providing advice and guidance to generations of graduate students. She died on 13 December 1999 after a six-month battle with non-Hodgkin’s lymphoma. Several of her

friends in the department purchased a bench in her memory, which is now placed in front of the Dow Building.



James Wilkes

In memory of Cynthia Miller—a bench at the northwest entrance to the Herbert H. Dow Building, October 2000.

Prof. Levi Thompson first met Cynthia when he was one of our graduate students in the early 1980s. “I count Cynthia as one of my dearest friends in the department. She helped to type my dissertation, occasionally fed me, and, perhaps more importantly, helped keep me focused. I learned a great deal from her about perseverance, professionalism, and loyalty. More recently, Cynthia worked with my research group. She was a mother figure, a role that my students and I cherished, and which I think she enjoyed. Each of my former students sent condolences on her passing. We miss her dearly.”

Peter Severn†

For 31 years, faculty and students came to Pete Severn’s office in search of a collaborator, artist, teacher, surrogate father, or friend. In each case, they found a highly competent, modest, kindly man, who retired on 31 January 1991.

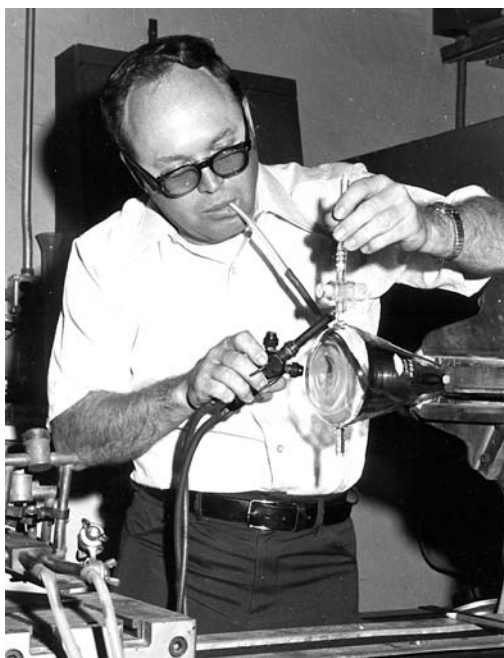

James Wilkes

Peter Severn, East Engineering, 1973.

When asked about what kinds of glass items he made as the master glassblower in the College of Engineering, Peter Severn joked, “A lot of the things I made don’t have a name.” Severn’s trademark was his ability to generate original forms to suit essential functions in an era filled with facsimiles.

Jointly appointed by the departments of Chemical Engineering and Materials Science and Engineering, Severn was one of a handful of master glassblowers

† Excerpted from an appreciation by Deborah Meyers Greene in the *Michigan Engineer*, Summer 1991.

maintained on staff by major teaching institutions across the country. During his tenure, Severn created and manufactured glass objects integral to research through the U–M community. His work also provided items used in the world’s first heart transplant as well as in NASA explorations.

“Pete was involved integrally in the design, conception, and building of some of the most sophisticated equipment that we work with in both departments,” said Ronald Gibala, then chairman of the Materials Science and Engineering Department. “He has been critical in the advance that have been made in our department over the course of many decades. With Pete’s help we could start an experiment for which the equipment was not yet available; we could do the highly unusual.”



Harald Eberhart and Peter Severn.

Johannes Schwank offered as an example of Pete’s skill—an eight-foot-tall vacuum chemisorption system, which measures the number of active sites on catalytic materials, and functions as a recycle reactor for the isotopic exchange of oxygen. “Pete was involved in the design and all the preliminary activities,” said Johannes. We discussed with him the capabilities the vacuum system should have and gave him preliminary drawings. He was able to translate it into three dimensions, and it wouldn’t have been done without him. Two large separate reactor systems built by Pete were brought out to North Campus when we moved here in 1982, and we then merged them into one. It is very difficult technically to build such a large glass vacuum system without a single pinhole. But Pete could do it.”

Peter Severn traveled a winding path to Ann Arbor. Hailing from Elkton, a tiny town in the “thumb” of Michigan, he was first a state park ranger, and then operator of a service station, before arriving at the U–M in 1960. He trained with David Meyers, an earlier master glassblower in the Chemistry Department.

Retirement is a relative term for Pete, because since then has established his own business, a consultancy to various research and development concerns. However, he misses the department, which had provided him with “. . . a second family. I will miss the students. My room usually had several students in it most of the day.” He also explained “I love golf, so some years back I helped to put together a little series of golf outings for the department, which we have every summer.”

Jim Wilkes said “Peter is one of the people in the department who has made life here worthwhile and enjoyable. He is a true gentleman, admired by everybody.”

Ron Gibala concluded “Pete’s the kind of person who could ask ‘Now, what do you really want to do?’ Then he would sit down and do it. He reminds me so much of my father, who would add a room to the house, with never a drawing made. Pete is one of those artists who is able to do that. We’re going to miss him.”

Keeran Srinivasan



David Smith

Dr. Keeran Srinivasan, or “Doc,” as he was affectionately known to his colleagues and students, had two master’s degrees—one in analytical chemistry from the University of Bombay and the other in bioengineering from Michigan. He also had a Ph.D. in physical chemistry from Carnegie Mellon University. He joined our department in 1982 as a research assistant. During Keeran’s first ten years with us, he worked with the research groups of Jerry Schultz, Scott Fogler, and Henry Wang. In the early 1990s he was appointed as an instructor and spent most of his time teaching in the ChE 360 and 460 laboratory courses. Prof. Scott Fogler and his research group worked with “Doc” for more than 16 years. “Doc was an extremely talented re-

searcher and team member, and an out-of-the-box thinker,” recalls Scott. “He always had a different perspective and way of looking at things and made numerous contributions to the students’ projects in a number of groups in the department. Doc thoroughly enjoyed interacting with the students and faculty and always enjoyed a good debate about some scientific principle—or, for that matter, any topic on which he had an opinion, which was just about everything!”

Prof. Fogler also remembers the spirit with which Doc entered into everything he did. In the mid-1980s, the annual party for Scott’s graduate students always included some sort of game before dinner, such as a road rally. Doc approached the competition as if it were the finals of an Olympic trial, and he was the evenings’

winner more than 80% of the time. Keeran died in July 2000 while traveling in Tibet. When he was to have returned from this trip, he and Scott were looking forward to Doc's increased participation in Prof. Fogler's research group. Dr. Srinivasan worked hard at doing a good job in every task he undertook. He will be missed not only for his colorful character, but also for the energy he gave to our department and, most importantly, for being a friend and colleague to all of us.



Cynthia Miller, Sandra Swisher, Sharon Thatcher, and Joyce Ruppert. Photo is from mid-to-late 1980s.



Valerie Franklin, Sharon Thatcher, and Sandra Swisher, in the front office of the Herbert H. Dow Building, just after our move in 1982.

Sharon Thatcher

Sharon joined our department in 1976, first working in the undergraduate office, then in the graduate office, before becoming assistant to the chair in 1978†. Until her retirement in 1999, she had assisted four chairs—Profs. Schultz, Fogler, Schwank, and Yang. another of her many duties was to interact with industrial recruiters from all over the country. She made it her responsibility that they and all guests of the department “felt like they’re coming home.” She was also assistant editor of the department’s *Newsletter* for several years.



James Wilkes

Sharon and Bob Thatcher, August 1998.

For Sharon, the new challenges and “the great people I work with, faculty and co-workers,” were the best parts of her job. Sharon’s philosophy is simple: “If someone asks you to go a mile for them, go two. That means listening, asking questions, fulfilling the needed, and making a lasting impression with your actions. I have a great deal of respect for others, and I expect the very best from myself.” Sharon has a degree in business management from Cleary College.

For many years, Sharon also made the arrangements for the annual Donald L. Katz lectures and accompanying dinners. She was one of the key personnel involved in the planning and coordination of our successful 1998 Centennial, and undoubtedly put more work into this than anybody else.

† Taken mainly from the U–M College of Engineering publication *What’s New*, October 1992.



James Wilkes

“Fanny” Bolen (at his retirement dinner), Sharon Thatcher, and John (“Jack”) Powers. Michigan League, 28 April 1981.

SOME PRESENT STAFF MEMBERS

Our current staff members are listed in Table 29, followed by biographical sketches of those who have been with us for ten years or more.

Table 29 Chemical Engineering Staff, 2002

Michael A. Africa	Computer Systems Consultant III
Laura D. Bracken	Research Secretary III
Melissa Bower	Academic Services Secretary II
Cynthia G. Collins	Administrative Assistant I
Leslie B. Cypert	Research Secretary IV
Harald W. Eberhart	Master Glassblower
Christine M. Garman	Academic Secretary III
Susan E. Hamlin	Student Services Assistant II
Ruby Sowards	Academic Secretary IV
Pablo P. LaValle	Senior Engineer
Claire O’Connor	Administrative Associate II
Sandra G. Swisher	Student Services Assistant II
Donald A. Trombley	Engineering Technician III

Laura Bracken

James Wilkes

Laura Bracken is a Research Secretary III and has been with the Department of Chemical Engineering since December, 1983. For the most part, she has worked with Professor Scott Fogler. When she first started it was to help with the first edition of his book, *Elements of Chemical Reaction Engineering*. The third edition of this book was recently published. When Laura first hired, the department was on the verge of the personal computer age. There were only a few computers in the department, and one printer for the staff to use. She notes that it seems so ancient now, to think about a time when we did not have a computer. Today we all have at least one computer.

Pablo La Valle

James Wilkes

Pablo La Valle, who is a native of Buenos Aires, Argentina, came to Ann Arbor in 1976 to work as a laboratory associate at the AMAX Research Center. While there, he completed his studies in chemical engineering at the University of Michigan, receiving his B.S.E. in 1982. As a U-M undergraduate, he was a member of Tau Beta Pi. Subsequent employment was as a process engineer with Warner Lambert in Holland, Michigan (1983–1984) and as a research associate at AMAX (1984–1987). Pablo was a co-author of U.S. Patent No. 4,495,157, *Recovery of Metal Values from Spent Hydrodesulfurization Catalysts*. In 1993, he received an Excellence in Staff Service Award from the U-M College of Engineering.

Since 1987, Pablo has been a Senior Engineer in chemical engineering at the U-M, where his main responsibilities are:

1. As a laboratory design engineer, to design all the equipment used in the two undergraduate instruction laboratories, ChE 360 and ChE 460. He also plans, supervises and actively participates in the construction, modification, installation, and maintenance of all this equipment. When the need arises, he helps the faculty or the undergraduate students with designs for modifications to the equipment.

2. As an instructor, he lectures and teaches the students in the proper and safe use of all the laboratory equipment. He acts as laboratory supervisor during the scheduled laboratory sections in both the junior and senior laboratories in the fall and winter terms. At times, when the student enrolment is high, he is also responsible for the spring term ChE 360 laboratory and associated lectures. He cooperates with the faculty in the planning and preparation of the curriculum and laboratory assignments for ChE 360 and ChE 460.
3. As an expert resource for faculty and graduate students, Pablo assists with equipment design, construction, modification and maintenance, room improvement and renovations required in the research laboratories. He also supervises the work of the department's engineering technician.

Harald W. Eberhart



James Wilkes

Harald Wolfgang Eberhart, scientific master glassblower in our department, emigrated at the age of ten with his parents from the 1,000-year-old city of Graz, Austria, in 1960, and was “uprooted” to Elliot Lake, Ontario, Canada. Elliot Lake, a uranium mining town in the middle of the bush, was his introduction to North America. He had to struggle with English and a foreign culture. After Harald's father was established for four years in this new country, he quit mining uranium and the family moved to Windsor, Ontario, where his father became employed at the University of Windsor. In 1962, at the age of 14, Harald started glassblowing in the basement of his home after school and on weekends, in a program similar to the European glassblowing educational system.

Harald's father, Wolfgang R. Eberhart, graduated at the age of 22 as the youngest master glassblower in the history of Austria, and Harald knew that apprenticing under him would provide him with extraordinary glassblowing knowledge in a very rare profession. Harald's father was his greatest educator, even though Harald himself has over 36 years of experience. Harald learned scientific glassblowing informally during his high-school years, but undertook the endeavor seriously in 1969 when he became employed for four years under his father's daily instructions at the University of Windsor, Canada.

From 1969 to 1974, Harald learned old-world technical glassblowing secrets, including new trade secrets his father invented through Pyrex Lampworking. From 1975 to 1991, Harald worked at the Dow Chemical Company in Midland, MI, and received his master's degree in October 1980. A patent soon followed for

a demountable plasma torch. In Midland, he started his own personal artistic glassblowing business, and sold his work mostly privately in Michigan and Canada.

Harald has been employed at the University of Michigan since 1991, where he has an outstanding glass laboratory with plenty of supplies and space for research glassblowing. He is in his twelfth year working for the College of Engineering. His duties involve a vast array of technical glassblowing. For the Chemical Engineering Department he has built a volatile organic compound oxidation catalyst and platinum reactor for studying exhaust gases. For the Materials Science and Engineering Department he has built reactors that produce nano-size particles that can be used to glue bones together as well as having uses in a new generation of batteries. For the Physics Department he has built MASER cells that allow the study of internal soft-tissue magnetic-resonance imaging. For the Physiology Department he has built heart chambers that allow the study of soft tissue using electrical as well as medical stimuli. Harald works very closely with faculty and graduate students, building custom glass apparatus for many interesting projects. He was nominated for the university-wide “Workplace 2000 Award” and has been placed on the Honor Roll. He has also been nominated for a third term as secretary/treasurer of the American Scientific Glassblowers Society. His hobbies are artistic glassblowing, neon art, foreign music and food, and attending cultural events.

Sandra Swisher



James Wilkes

“In August 1982, I started working in the undergraduate program office of the Chemical Engineering Department, which had just moved from East Engineering the week before. At the time, the north side of the first floor (where the Engineering Library would eventually move into and occupy until 1996, and where the Manufacturing Research Center is now) had not then been completed. When school began in September, some of the first ChE students I met came running frantically into my office because they couldn’t find their ChE classrooms. They had taken the northeast staircase (by the G.G. Brown Building) down two flights to a huge, dark, empty room. The first floor classrooms were accessible from the stairs and elevators on the

other side of the building but on that first day of classes in 1982 I’m sure some students must have wondered if the Chemical Engineering Department had disappeared during the summer!

It’s hard to believe that 20 years have come and gone since that first fall in the new building. During my time here, I have had the opportunity to meet hundreds

of undergraduate students—to learn about their families and hometowns, and to hear about their plans for the future. I have completed two degrees since 1982 and I can remember numerous conversations I have had with ChE students, in which we supported each other as we struggled through our respective programs. So many of the students encouraged me as I completed my degrees (a B.S. in English language from Eastern Michigan University in 1988, and a master's in information and library studies from the U-M in 1997) and celebrated with me when I finally graduated.

Professor Dale Briggs had just been appointed undergraduate program advisor when I came to the department. He was always a popular professor who took a great interest in the students and I enjoyed working with him for 15 years. Susan Montgomery took over as the program advisor in 1997. She was one of the first undergraduates I met when I came to the department. She was an active undergraduate and is even busier today, nearly 20 years later, as a teacher, program advisor, and mother.

I feel thankful for the many friends I have made through the years, and no matter where I am in another 20 years, I will always fondly remember my time in this department.”

CENTENNIAL CELEBRATIONS

1998—OUR 100TH BIRTHDAY

OUR Centennial Celebration, held on the evening of Friday 8 and all day on Saturday 9 May 1998 in conjunction with the Materials Science and Engineering Department, was an historic and extremely successful occasion, attended by some 250 alumni, faculty, and friends. It had been wet and cold for several days before the gathering, but miraculously the weather cleared and the sun shone on the big day—and immediately worsened after everybody had left.



James Wilkes

Centennial banner, above S.E. entrance to the H.H. Dow Building, May 1998.

The following overall program shows the events enjoyed by our alumni. The accompanying photographs were taken during the various events.

Friday, 8 May 1998

- 5:30–7:00 PM: Welcome reception, Michigan Union, Main Campus.
- 7:00 PM: Dinner on your own.

Saturday, 9 May 1998

- 8:00–9:00 AM: Registration & continental breakfast, Chrysler Center, North Campus.
- 9:00 AM–12:00 Noon: Centennial symposium, Chrysler Center.
- 12:00 Noon–1:00 PM: Lunch with carillon accompaniment.



Charles Sleicher, PhD '56; Robert Pehlke, Ronald Larson, faculty; Ralph Yang, fac.



Ralph Yang, faculty; Robert Hennig, BSE '53.



Jerome Schultz; Warren Seider, PhD '66; Mark Burns, faculty.



Rasin Tek, PhD '63; Jim Wilkes, PhD '63; Clifton Goddin, BSE '36, MSE '37, PhD '65.

- 1:00–3:00 PM: Optional Events
 - Chat with friends in the newly decorated Walter J. Podbielniak Lounge in the Chemical Engineering Department.
 - Photographic studio: We will take your photograph and include it in the forthcoming *History of the Chemical Engineering Department*.
 - North Campus walking tours—there are many new buildings, and the Media Union and carillon are spectacular.
 - Open laboratories and posters—come and meet our faculty and students, and see what research and teaching we are doing.
- 3:00–6:00 PM: Free time. You may wish to visit the Main Campus, bookstores, and other places in Ann Arbor.
- 6:00–7:00 PM: Social hour, Weber's Inn, Jackson Road, Ann Arbor.
- 7:00–9:30 PM: Centennial banquet, Weber's Inn. Entertainment will include a slide show of the good old days in East Engineering, and brief remarks by alumni.

Welcome Reception

At the informal reception in the Kuenzel Room of the Michigan Union on Friday evening, it was a pleasure to greet many former students. Brice Carnahan welcomed the guests on behalf of the department; attendees were able to enjoy their choice of the many Ann Arbor restaurants for dinner.



*Harold McCaskey, BSE '49;
Van J. Wolf, BSE '40.*



*Talivaldis Cepuritis, BSE '58, MSE '59;
Gunta Cepuritis; George Miley, PhD '59.*

Symposium



Ralph T. Yang



Albert F. Yee

After the Saturday 8:00–9:00 AM continental breakfast at the North Campus Chrysler Center, we were treated to a symposium introduced by chairs Ralph Yang (ChE) and Albert Yee (MSE), with the following five speakers and topics.

- Stephen W. Director, Robert J. Vlasic Dean of the U–M College of Engineering: *Welcome.*
- Stuart W. Churchill, former U–M student and professor, now the Carl V.S. Patterson Professor Emeritus of Chemical Engineering at the University of Pennsylvania: *Years of Glory.*

- James Wei, Pomeroy and Betty Perry Smith Professor in Chemical Engineering and Dean of Engineering, Princeton University: *Changing Paradigms in Chemical Engineering*.
- James Duderstadt, U–M President Emeritus & Professor of Science and Engineering: *The Future of Education in the Digital Age*.
- Arden Bement, Basil Turner Distinguished Professor of Engineering, Purdue University, and U–M alumnus: *Developments of Materials Technology*.



Stephen W. Director

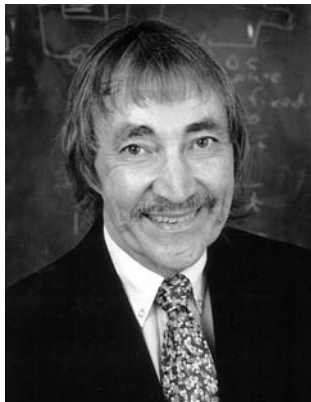

Stuart W. Churchill



James Wei



James J. Duderstadt



Arden Bement

Stuart Churchill (B.S.E. '42, Ph.D. '52) said he was proud to be back at Michigan, but was somewhat awed by those who knew the truth of what he was going to talk about! Nevertheless, he displayed a remarkable feat of memory by recalling the names of at least 150 of our graduates, from 1924 to the mid-1970s, who had become faculty members at other universities.

An abridged version of the talk by James Duderstadt (B.E.E.E. '64, Yale; M.S. (Eng. Sci.) '65, Ph.D. '67, Caltech) appears on page 495.

Lunch & Events

At noon, there was a fine West Texas barbecue buffet, served in a marquee on the lawn of the North Campus “Diag.” Nostalgic tunes were played on the new North Campus Ann and Robert H. Lurie Carillon by alumnus Richard Giszczak, who also gave demonstrations of the instrument to many visitors who went to the top of the tower after lunch.



James Wilkes

Richard Giszczak, B.S.E. '71, at the console of the Ann and Robert H. Lurie Carillon.

Noon Carillon Concert

- “When You’re Smiling”
..... Mark Fisher, Joe Goodwin, Larry Shay
- “School Days” Gus Edwards
- “When Irish Eyes Are Smiling” Ernest R. Ball
- “Sunrise, Sunset” Jerry Bock
- “I Want To Go Back to Michigan” Anonymous
- “Edelweiss” Richard Rodgers, arr. Janet Dundore
- “Que Sera, Sera” Ray Evans
- “God Bless America” Irving Berlin
- “The Victors” Louis Elbel

All the indicated selections were arrangements by Richard Giszczak, except “Edelweiss.” Richard graduated with a B.S.E. in ChE from the U–M in 1971. He then worked for several years in industry—for Amoco Corp., Velsicol Chemical Co., U.S. Industrial Chemical Co., Davy McKee Corp., and Cyro Industries, Inc. He started in academia in 1986, with the fourteen most recent years being back at the University of Michigan Chemistry Department in charge of health and safety and hazardous wastes. He began carillon lessons upon his return to the U–M and has enjoyed writing and playing his own arrangements.



*Elaine Brophy; Jere Brophy,
BSE '56, MSE '57, PhD '58.*



*Don Spink, BSE '45;
Helen Spink.*



*Brice Carnahan, PhD '65, faculty; Mary
Ann Wilkes; Sharon Thatcher, staff;
James O. Wilkes, faculty.*



*H. Scott Fogler, faculty; Peter Lederman,
BSE '53, MSE '57, PhD '61;
Charles Sleicher, PhD '56.*

After lunch, there was a variety of optional events—chatting with friends in the newly decorated Walter J. Podbielniak Lounge, carillon tours, open laboratories and posters, glass-blowing demonstrations, a room full of memorabilia, and North Campus walking tours that included many new spectacular buildings.

There was also ample time in the afternoon to visit the Main Campus, bookstores, and other haunts in Ann Arbor, or just to relax.



*Gretchen Tek; Rasin Tek,
BSE '48, MSE '49, PhD '53.*



*Peter Lederman, BSE '53, MSE '57,
PhD '61; Sue Lederman; Jim Wilkes.*



*Anna Waller, graduate student;
Cattaleeya Pattamaprom, grad. student.*



*F. Drake Parker, BSE '36, MSE '37;
Barbara Parker.*



*Albert W. Demmler, Jr.,
BSE '51, MSE '52, PhD '55.*



*Thomas H. Laity,
BSE '48, MSE '49.*



*George Miley,
MSE '56, PhD '59.*



*Charles Nagler, BSE '38,
MSE '39; Billie Nagler.*

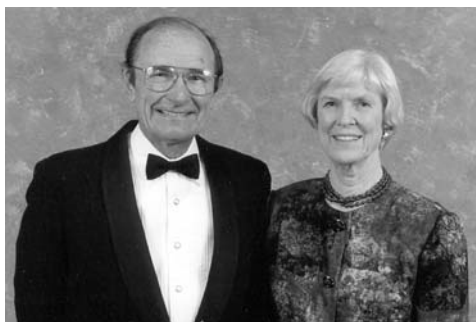

*Louis Dehmlow, BSE '50;
Carla Dehmlow.*



*Fred Shippey, MSE '76;
Ken Robinson, BSE '63, MSE '64.*



*Erdogan Gulari, faculty;
Warren Seider, PhD '66.*



Paul Jarenski

Centennial memorabilia.

Centennial Banquet

A social hour preceded the banquet at Weber’s Inn in Ann Arbor. All guests were warmly welcomed and pinned with a red boutonniere for the men, and a pink carnation corsage for the ladies. Graduates from the individual decades were seated together. Table decorations at each place-setting included take-home mementos: a colorful centennial commemorative navy blue mug, and a gold foil-wrapped and ribboned centennial chocolate bar. Centerpieces included warmly lit candles with fresh blue irises. An entree of salmon and filet mignon was enjoyed by all, followed by trays of pastries.

CENTENNIAL BANQUET
Saturday, 9 May 1998, 7:00 PM

Before Dinner

Phil Savage The Blessing

Dinner

Jim Wilkes Welcome and Introductions

Recognition of Graduating Doctoral Students

Chemical Engineering Brice Carnahan
 Materials Science and Engineering
 Joanna Mirecki-Millunchick

Nostalgia

Sara Soderstrom ('98E) Just Graduated!
 F. Drake Parker ('36E)
 The Badger Pipe-Fitting Trophy
 George Quarderer ('62E) Strange Events and Even
 Stranger People in East Engineering
 J. Wayne Jones The 20% View: MS&E and Me
 Peter B. Lederman ('53E) Happy Times
 Jim Wilkes Can You Top This?
 Brymer Williams ('36E) Yes!

The after-dinner proceedings were decidedly light-hearted and evoked countless laughs from the audience. Jim Wilkes was master of ceremonies, full of low-key humor in his own inimitable style, and started by thanking the many staff and students who had assisted with the Centennial. Brice Carnahan, chair of the ChE Graduate Committee, presented mementos to our graduating doctoral students. Joanna Mirecki-Millunchick (MS&E) made awards to graduate students from her department.



Joanna Mirecki-Millunchick



J. Wayne Jones

Sara Soderstrom (B.S.E. '98E), a vice-president of the Michigan Gamma Chapter of Tau Beta Pi, and who had just graduated the previous week, welcomed all alumni and related her experiences in the department and college. She and many of her ChE classmates had become firm friends. She liked the challenge and the applications-oriented nature of our curriculum, and noted the very high demand for U–M engineers and ChEs in particular. The U–M national hockey and football championships were a special bonus during her last year.

F. Drake Parker (B.S.E. '36E), now retired with his wife Barbara in California, gave a spirited and witty talk centered on the Badger Pipe-Fitting Trophy. He came to Michigan during the Great Depression, when there were bread lines and no beer. However, the repeal of Prohibition came about and brought happiness to all. He related his experiences with the “Four Bs”—Baker, Badger, Brier, and Brown. He was saddened to see East Engineering populated today by psychologists, whereas in his time it was the center of much greater excitement, with evaporators, pumps, crystallizers, and filters. As a teaching assistant with Badger, he participated in the famous challenge to students, in which they had to reassemble a dismantled pump; of course, Badger always removed a couple of the vital parts beforehand.

George Quarderer (B.S.E. '62E, Ph.D. '67), a research fellow and general troubleshooter with the Dow Chemical Company in Midland, related how Brymer

Williams and Louis York had fostered his career in chemical engineering, and gave an engaging snapshot of departmental life in the 1960s. Computer-program turnaround time with the MAD language was initially several days, and if something went wrong, you received either the feared binary dump of everything in the computer memory, or a picture of Alfred E. Neuman (“What, Me Worry?”). He touched on annual canoe outings with Bob Kadlec and Bill Hosford, how one departmental chairman caught up on his sleep during seminars (and awoke at the precise moment to ask a penetrating question), our fine workshop staff (Fanny, Pete, Doug, John, Frank, and Al), the friendship at the apartment (nicknamed the “Washtenaw Bar”) of Finis Carleton and Bill McDougald, and Joe Martin’s ever-lengthening equation of state.

Wayne Jones (MS&E faculty member since 1978) spoke for MS&E, recalling that Bill Hosford was late for Wayne’s initial interview because he (Bill) had to look after the chickens at home, and paid tribute to Larry Van Vlack’s outstanding reputation. There was a great spirit of camaraderie in the East Engineering coffee lounge (where Brymer Williams told many stories, some of them true) and during lunch at the Brown Jug, the epitome (?) of fine cuisine.



*Yisun Cheng, PhD '98;
Brice Carnahan, PhD '65, faculty.*



*Jane Schultz; Jerome Schultz;
Lori Director, Stephen Director, dean.*

Jim Wilkes (M.S.E. '56, Ph.D. '63) gave an engaging and fast-paced slide show of 100 years in the department—partly historical, largely humorous. He ended with pictures of Brymer Williams (B.S.E. '36, Ph.D. '49), saying that he was a much-loved faculty member and that his career had led him to know many students in the 1930s, 1940s, 1950s, 1960s, 1970s, and 1980s. Jim could think of no better way of concluding the Centennial Celebrations than by turning the podium over to Brymer.

Previous speakers had “scooped” almost all of Brymer’s prepared remarks, and instead he gave an ad lib performance that was a real *tour de force*. He recalled the beginnings of chemical engineering education at a few east-coast schools, and was thankful that he lived in an era when he knew virtually all of the early famous names in the field. But chemical engineering really got its boost in a small town

on the banks of the Huron River, in which our department produced not only practical people who built refineries but also research people who built for the future. Brymer astonishingly recalled the names of some fifty of our students over as many years, and how each of them had contributed to the profession. He expressed the utmost confidence in our faculty, the college, and the university in continuing its excellence for the next 100 years. As Brymer ended on a “Go Blue!” note, the audience leaped to its feet, and so concluded our celebrations.

Our thanks also go to all the chemical engineering and materials science & engineering staff members and students for the meticulous planning that made the Centennial so successful.†



*Peter B. Lederman,
BSE '53, MSE '57, PhD '61.*



*Brymer Williams,
BSE '36, PhD '49.*

Sara Soderstrom—ChE Centennial Dinner Speech

I would like to welcome all the alumni and alumnae of the Chemical and Material Science and Engineering Departments. I have enjoyed speaking with many of you today. I hope you are enjoying your weekend as much as I am. Lately, I have been thinking about my experiences within the College of Engineering and the Chemical Engineering Department. Last Saturday at graduation I was amazed how close our class is and how many of my best friends are my fellow classmates. I never would have imagined four years ago that I would have met so many wonderful people in my class. Nor would I have understood how challenged I would be by the professors and graduate students I have met here. I remember when I first heard of chemical engineering—I was a high-school student and my teachers all

† *ChE Staff*: Janet Bell, John Bell, Laura Bracken, Christine Garman, Cyndi D'Agostino, Harald Eberhart, Susan Hamlin, Natalie Jacobs, Pablo LaValle, Cynthia Miller, Sandra Swisher, Sharon Thatcher (*coordinator*). *ChE Students*: Naoko Akiya, Barry Wolf, Manish Chopra, Paul Suding, Priya Varadan, Jim Waldecker, Anna Waller. *MSE Staff*: Kay Artico, Renee Hilgendorf, Judy Hyde, Laraba Kendig, Georgia Knope (*coordinator*), Nancy Polashak, Bonni Viets, Joy Warwick. *MSE Students*: Carla Cloutier, Trevor Harding, Mike Johnson, Dave Norman, Greg Quist, Chris Soles.

said, “Well Sara, if you like science and you do well in mathematics, you should be a chemical engineer.” I figured I was set. Then, the first day in my first chemical engineering class, *Introduction to Thermodynamics*, Prof. Montgomery told us chemical engineering wasn’t like organic chemistry, or any other science class we’d taken up to that point. We all wondered, “What then *is* chemical engineering?” I heard all the rumors about engineers being secluded in cubicles with no human contact. I was worried. I looked into changing majors. I looked into the Business School. I spent a year trying to find something I liked other than chemical engineering.



Paul Jaronski

Sara Soderstrom, May 1998

Then I went to a panel discussion hosted by Omega Chi Epsilon, the chemical engineering honor society. Each of the panelists had a bachelor’s degree in chemical engineering. But that is where the similarities stopped. One man was in medical school. One was in business school. One woman was a materials science and engineering graduate student. Another was a chemical engineering graduate student. I realized that a chemical engineer could do just about anything. There is no typical chemical engineer. I think it was at this point that I finally accepted that I liked chemical engineering. I was excited about the rest of my classes. I think the aspect of the engineering education in this department that I liked best was the theory. My chemical engineering courses were some of the first where students were expected to understand the concepts, not just memorize equations. We learned to derive equations and modify them for certain applications.

I was so excited when I had my first chemical engineering laboratory course, because I could use the information I’d learned in all of my previous classes to analyze and understand the data. I realized how much I had learned over the past three years. I also realized how great my professors had been; they taught such complex ideas so that students not only understood them during the class, but also remembered them later. I would like to thank all of the professors of the department for making this experience so exciting and challenging.

I have been a Michigan fan for as long as I can remember. I think I went to my first football game before I could walk. It was also always a goal of mine to attend the University of Michigan. While I always knew that this was a great university, I am only now beginning to understand truly the doors that a degree from the U–M, and specifically the College of Engineering, can open. For the past two years I have been one of the chairs for the College of Engineering Career Fair. Hundreds of companies from across the country come here to recruit students. So

many companies want to hire Michigan engineers that we have had to expand the Career Fair from one to two days to accommodate the demand! Michigan engineers truly are some of the best and brightest.

The chemical engineers in the class of 1998 are also some of my closest friends. We have all had at least one class a semester together for the past three years. Something about the Dow Building at 8:30 in the morning and the Media Union at 3:00 in the morning breeds friendship. Somewhere amidst all the studying we learned to respect, trust, and enjoy one another. We learned that engineering is anything but sitting alone. We worked together. Teamwork was key to the success of many projects and laboratories. We had a great four years. North Campus evolved into a beautiful part of the university. The Media Union was built and is one of the nations best multi-media centers. And for our senior year, we got to celebrate the National Football Championship in Pasadena and the National Hockey Championship on South University.



Michael J. Schimpf

Media Union viewed through the base of the Ann & Robert H. Lurie Tower.

College was a combination of challenges and new experiences. Throughout it we learned to depend on ourselves and each other. Now, I find it amazing to see where all of my classmates are going. Some are going to graduate school in engineering like me. Others are going to law or medical school. Many are going into industry. But each job is truly different. Some are pharmaceutical, others automotive or petrochemical. The class of 1998 has proven that there is no typical chemical engineer. You, the alumni/ae of this department, have proven over the

past century that one can do anything with a chemical engineering degree from the University of Michigan. We, the most recent alumni/ae, will continue this tradition. Thank you and have a wonderful evening.

George Quarderer—ChE Centennial Dinner Speech

PERHAPS unwisely, I have been offered the opportunity to spend a few minutes to reminisce about the Chemical Engineering and Materials Departments, which I still collectively think of as the Chem/Met Department.



Paul Jaronski

George Quarderer, May 1998

My long-lasting fascination with chemical engineering dates to a series of informal conversations with Brymer Williams and Louis York, who took time from their busy schedules to set down with me one-on-one to talk about the chemical engineering profession. They also arranged for me to meet with several of their former students who were working in industry. While Louis York eventually left academia, Brymer kept up the good work of counseling and watching over the well-being of countless undergraduate students throughout his entire career. Don Katz was chairman during my days as an undergraduate. I don't mind saying that I and most of my contemporaries were a bit intimidated by Prof. Katz. He was a world-renowned expert in all things relating to petroleum; he had written several pivotal books in chemical engineering; and he had been president of the AIChE.

In CM 117 and 118, taught by Prof. Ken Gordon, the class of 1962 was thoroughly grounded in all of the basic chemical engineering unit operations. The approach followed was close to the classic text *Unit Operations*, published in 1950 by Prof. George Granger Brown and other members of the department. In the unit operations laboratory we had the opportunity to operate a spectrum of process equipment. Later I worked for Prof. Gordon as a research assistant. In 1962, I was shocked and saddened by news of his tragic and untimely death when he was about to return from sabbatical leave in England.

In the late 1950s, most routine calculations were still done using slide rules or logarithm tables. Freshman engineers took the introductory computer course, Math 73. Programs were written using punched cards and were run on the university's mainframe computer. Programming was done using the home-grown language MAD—Michigan Algorithmic Decoder. Turnaround time was typically several days. A logical or typographical error in your input program or a frayed punch

card was rewarded with a computer generated caricature of Alfred E. Neuman saying “What, me worry?” and the feared binary dump—the entire contents of the computer’s memory, all in binary form.

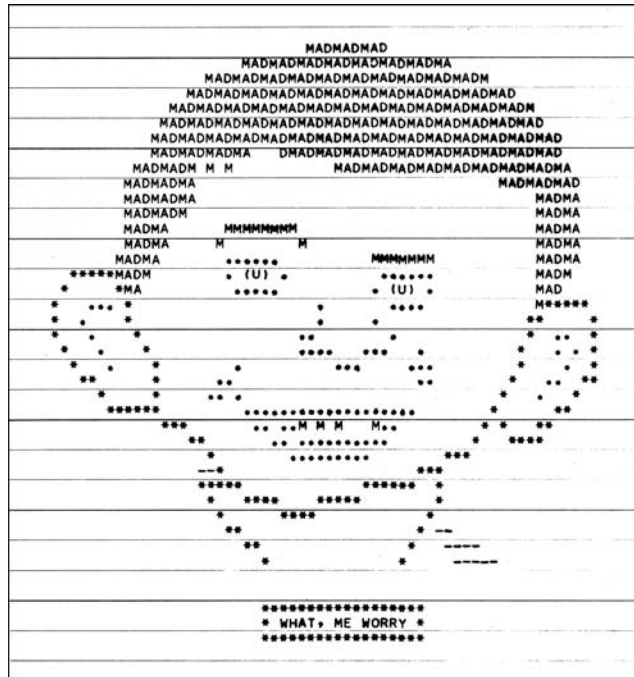

Alfred E. Neuman, from page E426 of the first annual report of the Ford Foundation Project, “Integration of Electronic Computers into the Undergraduate Engineering Educational Program,” Donald L. Katz, Director, Elliott I. Organick, Assistant Director, University of Michigan, August 1960.

A noteworthy department milestone was the publication of the first draft of the text *Applied Numerical Methods*, by Profs. Carnahan, Luther, and Wilkes in 1963. The first draft of this text was written using the MAD language. Half of the text’s examples dealt with the game of bridge.

One of my faculty favorites was Prof. Donald W. (Don) McCready. Don was an old-timer who taught courses in polymer science that were a thorough blend of theory and hands-on practicality. Prof. McCready once paid me the highest of compliments: “Quarderer, you rarely come to class. When you do you usually sleep in the back of the room. However, on the exams you seem to know the material. I don’t know how you do it.”

Bob Kadlec, my doctoral chairman, taught CM 400, an introductory course in mathematical modeling. If any course was designed with me in mind it was CM

400. Using the basic laws of physics and chemistry, macroscopic and microscopic balances were derived; the governing differential and partial differential equations were formulated; dimensional analysis was used to reduce mathematical complexity and to generalize the results; and advanced mathematical techniques were used to solve the equations to obtain global and asymptotic solutions.

Bob would periodically write up and distribute a new take-home problem. He would himself then attempt the problem solution. Occasionally, however, he had come up with a doosie of a problem. When that happened, Bob would drift innocently into the lab: “Quarderer, I’ve got this interesting new problem. I bet you a pitcher of beer you can’t solve it.”

“Cactus” Jack Brier, a professor emeritus, had worked in munitions and propellants during the Second World War. When Prof. Brier stopped coming into East Engineering, a small laboratory that he had used for storage was declared available. Fred Swinehart, a fellow student, claimed ownership and Fred and I set about cleaning out the room. Things went pretty well until we got to the Japanese hand grenades.

Brymer, the department’s safety czar, was immediately apprised of the situation. He assessed the situation and pronounced the grenades inactive. To show how much confidence he had in his appraisal, Brymer started pulling on what looked to be a grenade’s safety pin. He did this while blocking the room’s only exit. In a New York second, I ran over Brymer, bolted through the door, and fled East Engineering.



James Wilkes

*Brice Carnahan and Dale Briggs with the J. Louis York
“Graduate Student Emeritus Award,” Dec. 1964.*

The J. Louis York award was presented annually at the department’s fall picnic in German Park, and honored the graduate student who had spent the

most years in the department without finishing his degree. The awardee's name was painted onto a nondescript 50-pound chunk of polystyrene, which was prominently displayed. Several of the former award winners were (and are) faculty members in the department.

A number of students and faculty were avid canoeists. Bob Kadlec and Bill Hosford organized the annual spring canoe trips to the wilds of northern Canada. These one- or two-week trips were not for the faint of heart. Weeks, if not months of planning preceded every trip, which had to take place in the brief two-week window between the disappearance of ice and snow and the appearance of the feared Canadian black fly. Prior to each trip, weather conditions and snow cover in Northern Canada were monitored carefully by cajoling the folks in the Meteorology Department to download the appropriate satellite weather photos.



Peter Parker

Robert Kadlec appears to be loafing in the stern of the canoe while Wendell Heers does all the hard work. Ivanhoe river (which flows into the Groundhog river), Canada, 1 June 1971.

When people get lost in the wilderness supposedly they end up walking in a circle. I thought that this was an old wives' tale but was proven wrong by Bill McDougald. On a portage Bill wandered off and got lost. We retrieved him after he had made about three laps. There were several votes to let him go additional laps.

When Stu Churchill was chairman of the department he worked night and day. Writing books; a dynamic research program; running the department; a major force in the AIChE. To compensate, Stu developed a highly refined technique for catching up on the sleep that he was missing. Whenever there was a seminar in the department, Stu would introduce the speaker and as soon as the lights dimmed and the projector came on, Stu was sound asleep.

These weren't dainty little cat naps. These were the real thing with lots of head flopping and snoring. However, as soon as the presentation ended and the lights came back on, Stu was on his feet asking the most penetrating and insightful questions you could imagine.

Five minutes after I began the defense of my thesis Stu went out like a light. The rest of my committee and I exchanged knowing glances and pressed on with the work at hand while Stu dozed fitfully. At the end of my presentations, Stu awoke and the interrogation began.

The department had a top notch crew of skilled craftsmen: Al, Fanny, John, Doug, Pete Severn, and Frank Drogosz. Each had his specialty. If you treated them nicely they bent over backwards to help you with your research project. An important unwritten role of this group was to keep the students from injuring themselves. Many of the incoming grad students had few mechanical skills. Some of the foreign students were from countries where working with one's hands relegated you to a lower social stratum. In addition, everyone was in a hurry to get the degree and get out. One student was stopped as he was trying to unscrew the top off a hydrogen sulfide cylinder. Another student had Pete Severn, the department glass blower, construct an elaborate 6-ft tall extraction column and then held the column cross-wise as he attempted to walk through the 30-in. doorway out of Pete's shop.

Giuseppe Parravano, the department's catalysis guru, had a well deserved national and international reputation. To this day the Michigan Catalysis Society annually presents the Giuseppe Parravano Award to recognize outstanding achievements in catalysis. I always had a strong interest in catalysis and when the time came to pick a doctoral chairman, I considered working with Giuseppe. While Giuseppe's work in catalysis was outstanding, there was a significant downside to having him for a chairman—his graduate students were frequent winners of the J. Louis York Award.

Fellow graduate students Finis Carleton and Bill McDougald had an apartment on Washtenaw Avenue, not far from East Engineering. Their apartment was a convenient place for students and faculty to meet informally. Someone came up with a refrigerator. A carbon dioxide cylinder and regulator and plumbing supplies were midnight requisitioned from the department and *voilà*—light and dark beer on tap. The apartment was known as the "Washtenaw Bar."

This was a period when the demand for chemical engineers outstripped the supply. Recruiters were chasing people up and down the hallways of East Engineering. The word quietly went out. If you want to talk to a large number of graduate students in an informal setting, all you have to do is to put a quarter barrel into the refrigerator.

Most professors in the department dressed very casually. For some of them you could tell whether or not an event was important by whether or not they

were wearing their hunting licenses. An exception to the rule was Rasin Tek, a very dapper dresser. I taught several courses with Rasin in the Midland extension program. Commonly we would get together for supper before evening classes. Rasin had a well-developed appreciation for the finer things in life. His choice of wines was impeccable. Expense reports from these dinners went directly to Dow. After one of Rasin's expense reports was received, I got a call from Dow accounting. They very impressed by the price of the wines consumed.



James Wilkes

In the early 1960s, the apartment house at 1331 Washtenaw Avenue was home to several department graduate students, being conveniently located just two short blocks from the East Engineering Building. From 1964–1966, Apartment 1 became known as the “Washtenaw Bar,” as proprietors Bill McDougald and Finis Carleton always had refreshments on draft, ready to be served in a chilled glass. Late afternoons and evenings found graduate students, faculty, and staff gathering to debrief and relax following an intense day of teaching/research, and to plan the annual spring Canadian canoeing retreat. The comradeship that developed formed a special bond between students and faculty during that particular period. Photo: June 2000.

In 1966 when my wife, Carol, and I were expecting our first child we wanted to buy a cradle but funds were tight. By luck, I found a cache of disassembled oak desks in East Engineering and set about building the cradle myself with the aid

of the department's skilled craftsmen. In no time at all the cradle was done—and it was (and is) a thing of beauty. Shortly thereafter, Bob Kadlec returned from sabbatical and decided that it was time to start building his gun cabinet. When he discovered that his private cache of well-aged oak had vanished, he was not a happy camper.

Joe Martin was the department's reigning thermodynamicist during the 1960s. One of Prof. Martin's continuing research projects was the development of a generalized equation of state. The Martin-Hou equation was rumored to contain one adjustable parameter for each of Prof. Martin's graduate students during his long and distinguished career.

A number of faculty members had active consulting practices. If the university had regulations limiting the amount of consulting that could be done during the academic year, they weren't enforced. Graduate students were routinely given the opportunity to cover classes while their doctoral chairmen were away. Several of the graduate students were less than enthusiastic about these "opportunities." One of my contemporaries, Nick Prodany, did a detailed economic analysis of how much his doctoral chairman was making as a result of the classes being taught and then billed the professor accordingly. Nick went into medicine.

At the end of 1966, as I was trying to write my thesis, Scott Fogler arrived in the department. Like all assistant professors who have hopes of achieving tenure, Scott started out working like a dog. Unfortunately for those of us working near Scott's laboratory, his research area was sonochemical phenomena, with a specialization in loud sonochemical phenomena. Hour after hour, Scott's piezoelectric transducers hummed, screamed, and whistled monotonously. Fortunately for the sanity of following generations of graduate students, Scott eventually retired his piezoelectric crystals and developed lucrative interests in reaction engineering and sandstone acidization.

The central event of my college career was the Vietnam War. Each male student had to decide whether to go into ROTC or to take his chances with the draft. On one end of the spectrum was Ranger Bob Reeves, a West Point graduate with a full-ride graduate scholarship, who purposefully flunked out so that he could get to Vietnam sooner. At the other end of the spectrum, us normal folks were plotting to minimize our risk of being drafted.

On the 20th anniversary of the end of the Vietnam War, the Detroit Free Press ran an article listing all Michigan residents who were still missing in action. My eyes were drawn to the picture and short biography of John McCormack, a navy pilot. The article read in part: "... a 1962 graduate of the University of Michigan with a bachelor of science degree in chemical engineering."

Compared to the rest of the campus the Chemical Engineering Department of the 1960s was an apolitical place. There were exceptions however. Among the chemical engineering students, Ed Timm was a leader and organizer of one of the

perennial student rent strikes against rapacious landlords. For his efforts Ed was blackballed and could not rent an apartment in Ann Arbor for the rest of his academic career. Ed solved the problem by buying an old Blue Bird school bus to which he added a water bed and all the comforts of home. Nearly 30 years later the old bus, still ready to roll, sits in Harbor Springs, Michigan.

My first meeting with Costas Kravaris, the department's expert in non-linear control, was in the 1980s. After chatting we decided to continue our discussions over dinner at Costas' favorite restaurant. Costas volunteered to do the driving. My agreement to this offer was a serious, serious mistake. As the trip began, Costas was discussing an important technical issue as he drove across six lanes of traffic looking neither to the left nor to the right. While I yelled "Oh My God!" and three cars took evasive action to avoid running over us, Costas never lost his train of thought and continued the discussion. Each time he made a point in the discussion he would give the steering wheel a tug and we would swerve into a different lane. After a half hour of this Costas admitted that he was unable to find his favorite restaurant and we stopped so that he could call to ask directions. By day's end I had developed an improved appreciation for the true meaning of "non-linear control."

I'll end my reminiscences by describing New Year's Eve of 1965. Before going home for the Christmas holidays, three chemical engineering graduate students (Marty Javinski, Finis Carleton, and I) and our wives agreed to meet in Ann Arbor to celebrate the New Year together. Since I was to return first, I would make the reservations. Unfortunately, there were no reservations to be made. So I set about organizing a small private party for the six of us.

However, Bob Kadlec quickly got a whiff of what was happening: . . . Could he and his wife come? Next came Jim Wilkes, . . . , then Brice Carnahan, . . . , then Brymer, Before I knew what had happened, with little more than a day to prepare, I was expecting nearly 40 people for a New Year's Eve dinner with party to follow.

The prime rib was catered, tables and chairs were requisitioned from East Engineering, decorations were prepared, orders were given: you bring the wine; you're in charge of desserts; you handle the salad; I've got the vegetables and baked potatoes; you bring dinner rolls for 40, etc. Somehow it all came together.

It turned out to be a great evening, dinner at Finis's and Bill's, party at the Quarderer's. Several members of the faculty and their spouses did get just a bit rowdy. However, being the magnanimous person that I am, we don't need to get into the details (other than to say that Prof. Wilkes did replace the broken Christmas tree decorations). However, if there are any rebuttals to the comments that I have made, I may reconsider this generous offer.

Thank you for the opportunity to reminisce, it has been my pleasure.

Engineering Education for the 21st Century, by James J. Duderstadt†

REMEMBER the opening lines from Charles Dickens' *A Tale of Two Cities*? "It was the best of times, it was the worst of times It was the spring of hope, it was the winter of despair" These do indeed seem like both the best of times and the worst of times for higher education in America.



Paul Jaronski

James J. Duderstadt, 1994

On the one hand, in an age of knowledge in which educated people and their ideas have become the wealth of nations, the university has never been more important, and the value of a college education never higher. The educational opportunities offered by the university, the knowledge it creates, and the services it provides are key to almost every priority of contemporary society, from economic competitiveness to national security to protecting the environment to enriching our culture. There is a growing recognition that few public investments have higher economic payoff than those made in higher education. Intellectual capital or brainpower is replacing financial and physical capital as the key to our strength, prosperity, and well being.

Yet there is great unease on our campuses. The media continue to view the academy with a frustrating mix of skepticism, ignorance, and occasional hostility that erodes public trust and confidence. Throughout society we see a backlash against earlier social commitments such as affirmative action. And the faculty feels the stresses from all corners. There is a sense of loss of scholarly community with increasing specialization; and a conflict between the demands of grantsmanship, a reward structure emphasizing research, and a love and sense of responsibility for teaching.

So what are we facing? A spring of hope or a winter of despair? Is engineering education today adequately preparing our students for a world of practice and citizenship that is quite different from the one we have known? More broadly, is the university as we know it today capable of serving the rapidly changing needs of contemporary society?

I believe that the forces of change in higher education are far stronger than most realize. Furthermore, I believe that engineering education will not be exempt from these changes, but may be swept along at the crest of the wave of university

† James J. Duderstadt is president emeritus and university professor of science and engineering, University of Michigan. These remarks were edited by Dr. Suzanne Burr from a speech given by President Emeritus Duderstadt at the Centennial Celebration of the University of Michigan, Departments of Chemical Engineering and Materials Science and Engineering, May 9, 1998.

change. The status quo is no longer an option. We must accept that change is inevitable and use it as a strategic opportunity to control our destiny, retaining the most important of our values and our traditions.

The Forces Driving Change

The forces of change can be grouped into four areas: (1) financial imperatives, (2) societal needs, (3) technology drivers, and (4) market forces.

Financial imperatives. Since the late 1970s, higher education in America has been caught in a financial vise.¹ On the one hand, the magnitude of the services demanded of our colleges and universities has increased considerably. University enrollments, research, and graduate and professional education have all grown in response to societal demand. Yet the costs of providing education, research, and service per unit of activity have grown at an even faster rate. These university activities are dependent upon a highly skilled professional workforce (faculty and staff); they require expensive new facilities and equipment; and they are driven by an ever-expanding knowledge base.

As the demand for educational services has grown and the operating costs to provide these services have risen, public support for higher education has flattened and then declined over the past two decades.² And while the federal government has sustained its support of research, growth has been modest in recent years and is likely to decline as discretionary domestic spending comes under increasing pressure from federal budget-balancing efforts. The current paradigms for conducting, distributing, and financing higher education may not be able to adapt to the realities of our times. The higher-education enterprise in America must change dramatically if it is to restore a balance between the costs and availability of educational services needed by our society and the resources available to support these services.

Societal needs. We must recognize the impact of the changing nature of the educational services sought by our society.

The need for the services provided by our colleges and universities will continue to grow. Significant expansion will be necessary just to respond to a growing population, which will create a 30-percent growth in the number of college-age students over the next decade. But these traditional students are only part of the picture. Eighteen- to twenty-two-year-old high-school graduates from affluent backgrounds no longer dominate today's undergraduate student body. It is comprised also of increasing numbers of adults from diverse socio-economic backgrounds, already in

¹ Joseph L. Dionne and Thomas Kean, *Breaking the Social Contract: The Fiscal Crisis in Higher Education*, Report of the Commission on National Investment in Higher Education (Council for Aid to Education, New York 1997).

² David W. Breneman, Joni E. Finney, and Brian M. Roherty, *Shaping the Future: Higher Education Finance in the 1990s* (California Higher Education Policy Center, April 1997).

the workplace, perhaps with families, seeking the education and skills necessary for their careers.

We are beginning to see a shift in demand from the current style of “just-in-case” education in which students complete degree programs long before they actually need the knowledge, to “just-in-time” education through non-degree programs, to “just-for-you” education which is carefully tailored to meet the specific lifelong learning requirements of particular students. Yet our colleges and universities continue to focus on high-cost, residential education and to the outmoded idea that quality in education is linked to exclusivity of access and extravagance of resources. It seems clear that either existing institutions will have to change significantly or new types of institutions will have to be formed.

Technology drivers. Rapidly evolving technologies are dramatically altering the way we collect, manipulate, and transmit information. In the past several decades, computers have evolved into powerful information systems with high-speed connectivity to other systems throughout the world. The creation of virtual environments, where human senses are exposed to artificially created sights, sounds, and feelings, liberate us from restrictions set by the physical forces of the world in which we live. We can now use powerful computers and networks to deliver educational services to anyone, anyplace, anytime, confined no longer to the campus or the academic schedule.

Technology is creating an open-learning environment in which the student has evolved into an active learner and consumer of educational services, stimulating the growth of powerful market forces that could dramatically reshape the higher-education enterprise. We must face the possibility that the current paradigm of the university may not be capable of responding to the opportunities or the challenges of the new knowledge media or the needs of the digital generation.

Market forces. We generally think of public higher education as an enterprise shaped by public policy and actions to serve a civic purpose. Yet market forces also act on our public colleges and universities. Society seeks services such as education and research. Academic institutions must compete for students, faculty, and resources. In the past, most colleges and universities served local or regional populations. Universities enjoyed a monopoly over advanced education because of geographical location and their monopoly on credentialing through the awarding of degrees. Today all these market constraints are being challenged, as information technology eliminates the barriers of space and time and as new competitive forces enter the marketplace to challenge credentialing.

As a result, higher education is rapidly evolving from a loosely federated system of colleges and universities serving traditional students from local communities to—in effect—a global knowledge and learning industry. With the emergence of new competitive forces and the weakening influence of traditional regulations, the

higher-education enterprise is evolving like other “deregulated” industries, such as health care or communications.

Many in the academy would undoubtedly view with derision or alarm the depiction of higher education as an “industry” or “business” operating in a highly competitive, increasingly deregulated global marketplace. Nevertheless, this is an important perspective that will require a new paradigm for how we think about post-secondary education. It is clear that no one, no government, is in control of the higher-education industry. Instead it responds to forces of the marketplace. Universities will have to learn to cope with the pressures of this marketplace while preserving the most important of their traditional values and character.



Courtesy U-M Engineering Media & Marketing

James J. Duderstadt, dean of the College of Engineering, 1981–1986, in his office in the North Campus Chrysler Center.

Evolution or Revolution?

Both the pace and nature of change characterizing the higher education enterprise in America and worldwide will be considerably beyond that which can be accommodated by business-as-usual evolution. While some colleges and universities may be able to maintain their current form and market niche, others will change beyond recognition. Still others will disappear entirely. New types of institutions—perhaps even entirely new social learning structures—will evolve to meet educational needs.

So what might we expect over the longer term for the future of the university? It would be impractical to suggest one particular model for the university of the 21st century. There will be many forms, many types of institutions serving our

society. But there are a number of themes that will factor into the higher education enterprise:

- *Learner-centered.* Our universities must transform themselves from faculty-centered to learner-centered institutions.
- *Affordable.* Society will demand that we become far more affordable, providing educational opportunities within the resources of all citizens.
- *Lifelong learning.* In an age of knowledge, the need for advanced education and skills will require our institutions to provide opportunities for lifelong learning.
- *Interactive and collaborative.* Already we see new forms of pedagogy: asynchronous (anytime, anyplace) learning opportunities, more compatible with lifestyles and career needs; and interactive and collaborative learning appropriate for the digital age.
- *Diverse.* Higher education in America will continue to serve an increasingly diverse population with diverse needs and goals.

Rather than an “age of knowledge,” we could instead aspire to a “culture of learning,” in which people are continually surrounded by, immersed in, and absorbed in learning experiences. Higher education must define its relationship with these emerging possibilities in order to create a compelling vision for its future as it enters the next millennium.

The Challenges to Engineering Education

Let us now turn to the subject of engineering education. Study after study has suggested that dramatic change is necessary. There have been dozens of conferences and reports, major programs such as the NSF Engineering Coalitions and Systemic Initiatives efforts, and hundreds of efforts by individual engineering schools.³ Despite these efforts, many today believe that engineering education remains trapped in a mid-20th-century paradigm.⁴ We continue to provide a form of engineering education which is increasingly irrelevant to the changing needs of a profession—not to mention a society—that is already far beyond our universities. Let me list some of the more apparent issues and concerns.

The changing nature of engineering practice. Today, engineering practice is evolving rapidly in response to a rapidly changing world. The shifting nature of national priorities from defense to economic competitiveness, the impact of information technology, the use of new materials and biological processes—all have had deep impacts on engineering practice. Today’s engineering students will spend

³ Pister, Karl (chair), *Engineering Education: Designing an Adaptive System*, Board on Engin. Education (National Academy Press, Washington 1995).

⁴ Morgan, Robert P., Proctor P. Reid, Wm. A. Wulf, “The Changing Nature of Engineering,” *ASEE Prism*, May/June 1998, pp. 13–17.

most of their careers coping with challenges and opportunities vastly different from those currently practicing engineering—or current teaching faculty—have experienced.

While engineers are expected to be well grounded in the fundamentals of science and mathematics, they are increasingly expected to acquire skills in communication, teamwork, adaptation to change, and social and environmental consciousness. From this perspective, engineering education simply has not kept pace with this changing environment. It is only a slight exaggeration to say that our students are currently being prepared to practice engineering in a world that existed when we, as their faculty, were trained a generation or two ago. They are not being prepared for the 21st century.



Paul Jaronski

If the robe fits . . . Presidential Inauguration Day, 6 October 1988.

From specialization to integration. The intellectual activities of the contemporary university are partitioned into increasingly specialized and fragmented disciplines. Perhaps reflecting the startling success of science in the 20th century, most disciplines are reductionist in nature, focusing teaching and scholarship on increasingly narrow topics. While this produces graduates of great technical depth, it is at a certain sacrifice of a broader, more integrated education. We must question the value of narrow specialization at a time when engineering practice and systems are becoming more complex, involving components and processes from widely dispersed fields.

The essence of engineering practice is the process of integrating knowledge. Unlike the specialized analysis characterizing scientific inquiry, engineers are ex-

pected to be society's master integrators, working across many different disciplines, making the connections that lead to deeper insights and more creative solutions, and getting things done. Thus, engineering education is under increasing pressure to shift away from specialization to a more comprehensive curriculum in which topics are better connected and integrated.

Learning for life. We have to accept the fact that it is no longer possible (if it ever was) for engineering students to learn all they need to know during their undergraduate studies. As the knowledge base in engineering continues to increase at a rapid rate, the engineering curriculum has become bloated with technical material, much of it already obsolete. Most undergraduate engineering programs have already become almost five years in length. Furthermore, the effort to include new technical knowledge while retaining much of the old has squeezed out other important curriculum content areas. For example, at the University of Michigan, the humanities and social sciences component of the undergraduate curriculum has dropped to less than twenty credit hours, with as low as two credit hours of free electives in some engineering majors.

Even with this increasing technical content, most engineers will spend many months if not years in further workplace training before they are ready for practice. Acquiring the array of technical knowledge and experience is a lifetime goal and requires a personal commitment to continual learning. An undergraduate engineering education should be viewed as only the initial launch for a career, designed to place the student in an orbit of lifetime learning.

The professional degree. It is simply no longer possible to regard the baccalaureate degree as sufficient for professional practice. Today, engineering is one of the very few professions that require only an undergraduate degree for professional status. Most other knowledge-intensive professions such as law, medicine, and even business, utilize graduate programs built upon a diversity of undergraduate majors. Little wonder that the status of engineering lags somewhat behind those of other professionals with more advanced education.

The inadequacy of the baccalaureate degree for professional practice is becoming apparent to employers as well. There is an increasing trend to hire graduates at the master's or even Ph.D. level for technical work, while relying upon baccalaureate engineering graduates for supporting services such as sales and technical support. Although study after study has recommended that the master's degree become the accepted route into engineering practice, this continues to be resisted both by the profession and the academy.

Curriculum reform. The current sequential approach to engineering education, in which the early years are dominated by science and mathematics courses with engineering content deferred to the upper-class years, discourages many capable students. Students have little chance to find out what engineering is all about

until late in their undergraduate studies. It is not unusual to find students wandering into our counseling and placement offices in their senior year, still trying to find out what they are majoring in and what they can do with an engineering degree. Compounding this is the fragmentation of the curriculum, consisting of highly specialized and generally unconnected courses. Although everyone agrees that the undergraduate curriculum should focus on the fundamentals, few can agree on what content is truly fundamental.

While the rigor of the scientific and mathematics foundation of modern engineering is important, it must be augmented by the broader integrative approach characterizing engineering practice. Students must gain experience not only in solitary analysis but also in group work and hands-on “design-build-operate” projects. We must strive to integrate real design and process understanding into the educational system. Above all, we must challenge our students to think, to create, and to understand excellence.

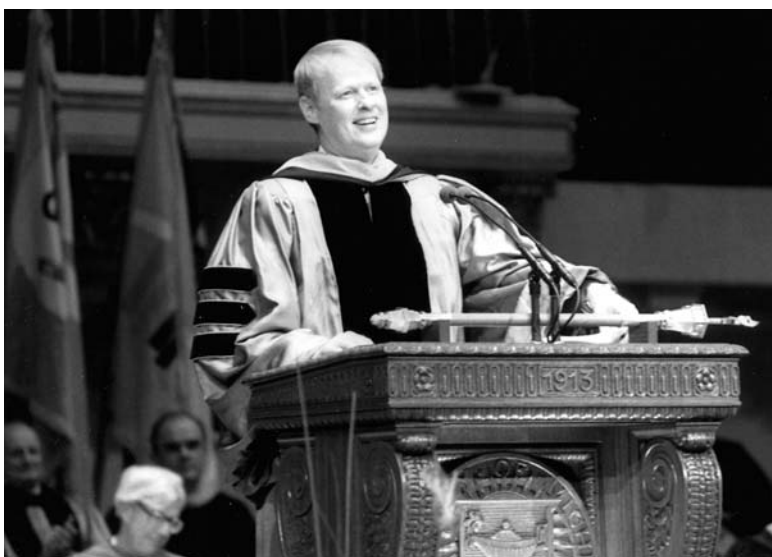

Paul Jaronski

James Duderstadt's first speech as the newly inaugurated president of the U-M, Hill Auditorium, 6 October 1988.

Shifting careers. In today's world of change, most graduates will find themselves frequently changing not only jobs, but entire careers. We already find that only about fifty percent of engineering graduates will enter technical careers, and, after five years, about half of these will have moved into other areas such as management or sales. Put another way, most engineering graduates of today will find themselves in engineering practice for only a relatively short period, if at all.

As Roland Schmitt has noted, we must enlarge the very concept of the engineer to cover a wider range of human activities than ever before. The increasing

importance of technology to our world has made an engineering degree an excellent preparation for many other careers and professions, such as business, law, medicine, consulting, and government service. This poses a particular challenge to engineering educators, since they still focus primarily on educating students for the engineering profession. Engineering educators must begin by realizing it is their duty to educate the leaders of our society as well as the professional engineer. This will require new objectives and curricula, because of a radically different objective: educating a new breed of graduates with an engineering-based “liberal education” for the 21st century.

Diversity. America’s population is changing rapidly. Today roughly eighty-five percent of new entrants to the workforce are minorities, women, or immigrants. It is becoming ever more apparent that the strength of our engineering workforce will be dependent upon our ability to provide these underrepresented groups with the opportunity for an engineering education.

The faculty. Engineering faculties are almost unique among those of professional schools since they generally have little professional experience. The strong research focus of most engineering schools has led to a cadre of strong engineering scientists, able at generating new knowledge but relatively inexperienced in professional practice. Furthermore, engineering faculty are judged by criteria appropriate to science faculty. Indeed, professional practice is not only absent in promotion criteria, but frequently discouraged. The faculty reward system recognizes teaching, research, and service to the profession but gives little recognition for developing a marketable product or process or designing an enduring piece of the nation’s infrastructure.

It would be hard to imagine a medical school faculty comprised only of biological scientists rather than practicing physicians, or music school faculty comprised only of musicologists rather than performing artists. Yet such detachment from professional practice is the norm in engineering education.

The Responses Thus Far

Engineering educators, professional societies, and federal funding agencies such as the National Science Foundation have not been insensitive to these concerns. Following an intensive dialog among the Accreditation Board of Engineering and Technology (ABET), engineering deans, and professional societies, ABET has significantly restructured its criteria for accreditation of undergraduate engineering education.⁵ The new Engineering Criteria 2000 include, among other elements, criteria that stress the importance of an engineering graduate’s ability to:

⁵ *The Vision for Change: A Summary Report of the ABET/NSF/Industry Workshops*, Accreditation Board for Engineering and Technology, May, 1995.

- Apply knowledge of science, mathematics, and engineering.
- Design and conduct experiments and analyze data.
- Design a system, component, or process to meet desired needs.
- Function on multi-disciplinary teams.
- Identify, formulate, and solve engineering problems.
- Understand professional and ethical responsibility.
- Communicate effectively.
- Understand the impact of engineering solutions in a global/social context.
- Engage in life-long learning.
- Exhibit a knowledge of contemporary issues.
- Use the techniques, skills, and modern tools necessary for engineering practice.

Many engineering schools have taken important steps to address concerns about engineering education. For example, the University of Michigan's College of Engineering is moving to implement a new Curriculum 2000 with the mission of preparing graduates to begin a lifetime of technical and professional creativity and leadership in their chosen fields.⁶ Michigan has chosen to identify three quite distinct educational paths:

- For students wishing to enter engineering practice at the highest level, a combined B.S.E./M.S.E. and B.S.E./M.Eng. path that can be completed in ten semesters.
- For students wishing to enter practice with only entry-level preparation or pursue graduate work in alternative fields, B.S.E. and B.S. paths that can be completed in eight semesters.
- For students interested in advanced graduate study, a research honors B.S.E. path characterized by significant research experience during the final two years.

Some of the more significant objectives of the new effort include:

- Adopting a four-course, four credit hours per course, eight-semester conceptual model for all B.S.E. and B.S. engineering curricula.
- Requiring all majors to have at least twelve hours of free electives.
- Offering a common curriculum for all first-year students so that it would not be necessary to decide on a major prior to the second year.
- Introducing a new first-year course, Engineering 100, which includes both team-oriented project work and technical communication.
- Instituting a program of "communication across the curriculum," with at least three credit hours of technical communication.
- Requiring that environmental issues and professional ethics be included implicitly in the curriculum.

⁶ Parsons, Michael G. (chair), *Michigan Curriculum 2000, Proposed Changes to the Undergraduate Curriculum*, University of Michigan College of Engineering (1996).

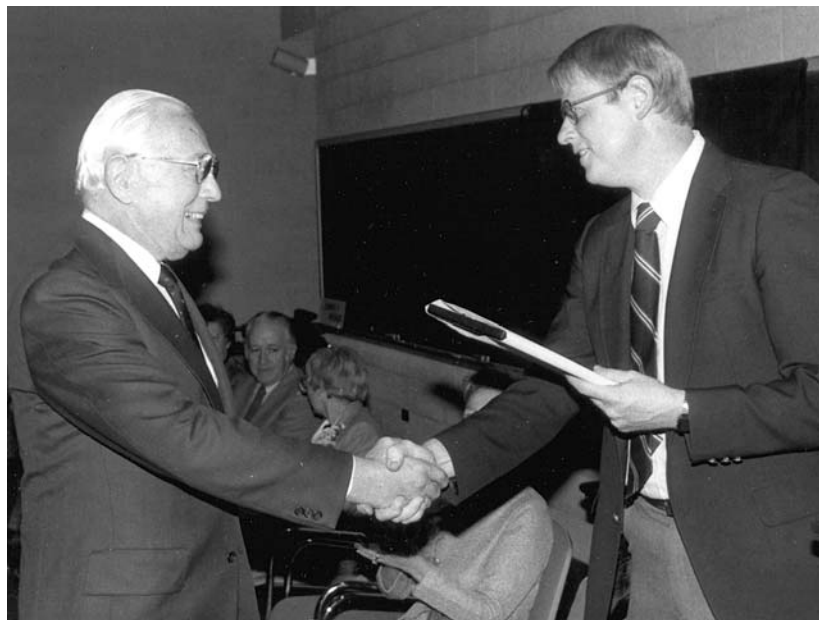

Bob Kalmbach

George Huebner (L), good friend of the U–M ChE department, receives a College of Engineering citation from Dean James Duderstadt, 1981. The recognition is for Huebner’s “significant contributions to the college, community, and university.”

The National Science Foundation has also played an important role in the modernization of the engineering curriculum. Programs have been launched encouraging curriculum innovation as well as a broader set of initiatives aimed at systemic change—such as the Engineering Coalitions Program. Furthermore, studies and workshops have been sponsored to define better the nature of the “new engineering education” appropriate for the 21st century. These studies suggest a new set of goals for engineering education:

- To offer a broad liberal education that provides the diversity and breadth needed for engineering.
- To prepare graduates for entry into careers and further study in both the engineering and non-engineering marketplace.
- To develop the motivation, capability, and knowledge base for lifelong learning.

The above will require a very major change in the engineering curriculum. To some degree, it will require modernizing the science and mathematics instruction—e.g., recognizing that discrete rather than continuous mathematics is the foundation of the digital age, that biology and chemistry are rapidly becoming more important than physics, that new materials and processes have made obsolete

much of the traditional curriculum. Beyond these technical changes, the NSF studies recognized that the new engineering curriculum must reflect a broad range of concerns, including environmental, political, social, international, and legal and ethical ramifications of decisions. The new skill set of engineering will be:⁷

- Engineering science (analysis).
- Systems integration (synthesis).
- Problem formulation as well as problem solving.
- Engineering design.
- The ability to realize products.
- Facility with intelligent technology to enhance creative opportunity.
- Ability to manage complexity and uncertainty.
- Teamwork (sensitivity in interpersonal relationships).
- Language and multicultural understanding.
- Ability to advocate and influence.
- Entrepreneurship and decision making.
- Knowledge integration, education, and mentoring.

How Can We Accelerate Change?

In the spirit of stimulating debate and thought, let me suggest a few Draconian actions designed both to shake up and transform engineering education.

Eliminate all specialized engineering majors, and broaden the perspective of engineering education. The contemporary engineer must span an array of fields. Perhaps it is time to abandon the concept of an undergraduate engineering major and instead provide a general engineering curriculum, much as in other professions such as medicine, law, and business. Like these professions, one could leave specialization until later, provided either through graduate study or on-the-job training. As noted earlier, engineering educators should be challenged to devise an engineering-based “liberal education” for the 21st century. We should produce graduates for all careers—from industry to law to government—with an education attuned to the issues and challenges of a knowledge-driven society.

Shift away from the classroom to more suitable forms of pedagogy. Clearly, those intellectual activities associated with engineering design—problem formulation, creativity, innovation—should be introduced throughout the curriculum. This will require a sharp departure from classroom pedagogy and solitary learning methods. Engineering education should move away from the current dominance of classroom-based pedagogy to more active learning approaches that engage problem-solving skills and team building. As a recent NSF workshop put

⁷ Bordogna, Joseph, “Making Connections: The Role of Engineers and Engineering Education,” *The Bridge*, spring 1997, pp. 11–16.

it, the ubiquitous lecture is the bane of true learning, especially in observation-based, hands-on fields such as engineering. Beyond team design projects, engineering educators might consider adopting the case-method approaches characterizing business and law education. More use might be made of internships as a formal part of the engineering curriculum, whether in industry or perhaps even in the research laboratories of engineering faculty, where engineering design is a common task.

Attract more practitioners into engineering education. It is absolutely essential to broaden the engineering faculty to include practitioners. One approach would be to work with industry to persuade and allow senior engineering staff to accept faculty appointments. In fact, many retired engineers would make ideal faculty members, bringing their wealth of experience not only to students but to the reshaping of the current science-driven culture of engineering schools. Of course, this would require significant restructuring of the faculty promotion and reward systems. It might even lead to the elimination of tenure, at least in some components of engineering education. But the mix of practitioners and scholars has been accepted and constructive in most other professional schools—medicine, law, business, architecture, and the fine arts. It seems high time to bring engineering education into line.

Conclusion

Those of us in higher education must always keep before us two questions: “Whom do we serve?” and “How can we serve better?” We must remove the constraints that prevent us from responding to the needs of rapidly changing societies, remove unnecessary processes and administrative structures, and question existing premises and arrangements. Universities should strive to challenge, excite, and embolden all members of their academic communities to embark on what should be a great adventure for higher education.

Certainly the need for higher education will be of increasing importance in our knowledge-driven future. Certainly, too, it has become increasingly clear that our current paradigms for the university—its teaching and research, its service to society, its financing—all must change rapidly and perhaps radically. The real question is not whether higher education will be transformed, but rather how . . . and by whom. If the university is capable of transforming itself to respond to the needs of a culture of learning, then what is currently perceived as the challenge of change may, in fact, become the opportunity for a renaissance in higher education in the years ahead.

Chapter 19

CHEMICAL ENGINEERING FACULTY, 1981–2002

CHEMICAL ENGINEERING FACULTY IN 2002

Stacy G. Bike



Bill Wood

Stacy G. Bike is an associate professor of chemical engineering and of macromolecular science and engineering. She is also the associate director of the Program in Manufacturing and the associate director of the Center for Advanced Polymer Engineering Research. She received her B.S., M.S., and Ph.D. degrees from Carnegie Mellon University, and joined the department in late 1988. She received a National Science Foundation Presidential Young Investigator Award in 1990. Professor Bike's research focuses on mechanistic studies of colloidal particles under dynamic conditions. The colloidal forces including van der Waals attraction, double-layer (charge) repulsion, and steric repulsion play a key role in the processing of many ad-

vanced materials that incorporate colloidal particles. Consequently, it is critical to understand the forces between the colloidal particles during each stage of the processing. Areas of active investigation in her laboratory include:

1. Quantification of cell-surface interactions using total internal reflection microscopy.
2. Elucidation of the mechanisms of stabilization of concentrated colloidal dispersions by polymers using rheological techniques.

The first area of research has led to the development of model cells that allow the contributions of specific cellular membrane components to be quantified systematically. The results of this research will aid in the design of drug-delivery devices and biomaterials. The second area of research involves studies of advanced

materials, including coatings, ceramics, and cementitious composites. This work in coatings has led to the development of new polymers for water-based coatings. Professor Bike has directed ten Ph.D. students and more than 40 undergraduate students in her laboratory. She has given more than 30 invited presentations at academic and industrial institutions and at conferences, and has authored or co-authored more than 25 publications. She is active in numerous professional societies, including the American Institute of Chemical Engineers, in which she is the technical program chair for the interfacial phenomena area, and the American Chemical Society.

Mark A. Burns



David Smith

Professor Mark Burns' research centers on developing new separation, purification, and analysis systems in the field of biotechnology. The design of new and efficient biochemical systems requires combining the knowledge of microbiology and biochemistry with the chemical engineering understanding of transport and reaction systems. In the area of biochemical separation and analysis, Prof. Burns has two distinct research programs: (1) recovery of proteins from cell cultures, and (2) analysis of DNA using microfabricated devices. In the first area, most soluble products of the biotechnology industry that are used to treat disease are produced from a variety of cell cultures. The unifying factor in these processes is that they almost always require a series of separation steps to obtain a product suitable for sale and use. The recovery of the desired biochemical is further complicated by the presence of whole cells or cell debris; these solid particles tend to foul most biochemical separation systems. Professor Burns' group, funded by the National Science Foundation, has developed several new separation systems that are unaffected by the presence of cells and that can perform a highly selective separation in just one step. In particular, the group has developed a separation system using a magnetic field and an ion-exchange resin that can simultaneously separate and concentrate a multicomponent mixture. Another device uses an oscillating flow through an adsorptive membrane to extract a single component selectively from a suspended cell culture.

The second area of research involves deciphering the genetic code contained in DNA, the information-carrying molecules found in all living things. In analyzing the genetic code, researchers are currently limited by the speed at which they can obtain the information. Robotic workstations and complicated sequencing

equipment currently fills rooms at many research facilities, but the output from these laboratories is still unable even to approach the demand for the information. Professor Burns' group, in conjunction with Profs. David Burke in the Human Genetics Department and Carlos Mastrangelo in the Electrical Engineering and Computer Science Department (both at the U–M), are developing miniaturized systems that will reduce the cost, labor, and time associated with DNA analysis. The collaboration, funded by the National Human Genome Research Institute at NIH, is using techniques developed by the computer industry to microfabricate biochemical reaction and separation systems that are the size of a typical computer chip. The devices are capable of injecting and moving nanoliter- and picoliter-sized DNA samples to various areas of the chip. The samples then undergo a specific amplification or digestion reaction followed by a high-resolution separation. The devices, when completed, will be able to process a DNA sample in minutes and can be marketed in battery-powered, calculator-sized units.

Professor Burns has taken the knowledge gained in these research areas and redirected it to the graduate and undergraduate students at Michigan. He has taught a variety of courses including *Separation Processes* (ChE 343) and *Intermediate Transport Phenomena* (ChE 542). He has also co-developed three new courses with other faculty at Michigan: *Engineering Fundamentals in Biological Systems* (ChE 518), *Advanced Biochemical Technology* (ChE 617), and *Cellular Biotechnology* (CBTP 504).

Professor Burns earned his B.S. in chemical engineering from the University of Notre Dame and his M.S. and Ph.D. in chemical and biochemical engineering from the University of Pennsylvania. He taught for three years at the University of Massachusetts before joining the department in 1990. Professor Burns has approximately 100 papers, patents, and presentations in which he has described his research and teaching. He has won several awards including the College of Engineering Teaching Excellence Award and a National Science Foundation Initiation Award.

H. Scott Fogler

H. Scott Fogler, P.E., the Vennema Professor of Chemical Engineering, received his B.S. (1962) from the University of Illinois and his M.S. (1963) and his Ph.D. (1965) from the University of Colorado. He enjoys teaching the undergraduate and graduate chemical reaction-engineering courses, and a graduate-level seminar on strategies for creative problem solving. He is the author of *Elements of Chemical Reaction Engineering*, which is estimated to be used by over 80% of all chemical engineering programs in the United States and is the dominant book world-wide. The third edition of the book was published with an interactive CD-ROM containing living example problems, interactive computer modules, interactive lecture notes, a professional reference shelf, Web modules on both stan-

standard (membrane reactors) and novel (cobra bites) applications of chemical reaction engineering. He and Prof. Steven LeBlanc are co-authors of *Strategies for Creative Problem Solving*, which won the Meriam-Wiley Distinguished Author Award from the ASEE in 1996. A research monograph *Migration of Fines in Porous Media*, co-authored by K. Khilar, was published by Kluwer in 1998.



Professor Fogler has graduated 27 Ph.D. students from his research group and has published over 160 research articles. He and his students are well known for their work in porous media, which encompasses a number of fundamental chemical engineering areas, specifically: reaction engineering, colloids, separations, and multiphase flow. Research topics include: flow, reaction, and precipitation; colloidally-induced fines migration; bacteria growth and transport; dissolution of carbonate materials; enhanced oil recovery, the use of laser-enhanced etching; colloidal phenomena; and catalyzed dissolution of minerals and semiconductors. In addition to funding by government agencies, an industrial affiliates program consisting of

major oil companies has supported the research on flow and reaction in porous media. A number of research results are now being used in industrial applications.

Scott Fogler has received a number of distinguished awards at college, university, and national levels. At the college level he received the Class of 1938 Award for Excellence in Teaching in 1971, the Dow Outstanding Young Faculty Award in 1972, the Excellence in Research Award in 1980, the Ame and Catherine Vennema Endowed Chair in Chemical Engineering in 1984, and the Stephen S. Attwood Award for Excellence in Teaching and Research in 1995. From the University of Michigan he received the Distinguished Faculty Service Award in 1971, the Phi Lambda Upsilon Teaching and Leadership Award in 1977, and the Distinguished Faculty Achievement Award in 1996. At the national level he was featured as ChE Educator in Chemical Engineering Education in 1978 and received the Chemical Engineer of the Year Award from the Detroit Section of the American Institute of Chemical Engineers in 1980. He received the ASEE Corcoran Award for best paper (shared) in 1992 and in 1994 he was named a fellow of AIChE and elected to a three-year term as director of AIChE.

In 1995 he was the recipient of the Warren K. Lewis award from the AIChE for contributions to chemical engineering education. In 1999 he received the National Catalyst Award from the Chemical Manufacturers Association. He has been the recipient of seven named lectureships: the inaugural Adler Lectureship at Case Western Reserve University (1994), the McCabe Lectureship at North Car-

olina State University (1994), the inaugural Tis Lahiri Lectureship at Vanderbilt University (1995), the Harry G. Fair Lectureship at the University of Oklahoma (1996), the Merck Sharp & Dohme Lectureship at the University of Puerto Rico (1997), the Phillips Lectureship at Oklahoma State University (1997), and the Johansen-Crosby Lectureship at Michigan State University (1999).

Sharon C. Glotzer



Sharon C. Glotzer joined the Department of Chemical Engineering at the University of Michigan on January 1, 2001 as an associate professor. She also holds joint appointments in Materials Science and Engineering, and Macromolecular Science and Engineering. Professor Glotzer received a B.S. in physics from the University of California, Los Angeles in 1987 and a Ph.D. in physics from Boston University in 1993. She spent two years as a National Research Council Postdoctoral Fellow at the National Institute of Standards and Technology, where she co-founded the Center for Theoretical and Computational Materials Science (CTCMS). For the past six years, she served as the deputy director and then director of the CTCMS, work-

ing with industry and academe to accelerate progress in computational materials science and its impact on U.S. industry.

Professor Glotzer has received many awards and honors, including the Presidential Early Career Award for Scientists and Engineers, the American Physical Society's Maria Goeppert-Mayer Award, and the Department of Commerce Bronze Medal Award, and she is a member of the Sigma Xi Distinguished Lecturers College. She is an active member of the American Institute of Chemical Engineers, American Physical Society, Materials Research Society, and American Chemical Society, and is involved in numerous organizational and advisory activities in computational science and engineering, both nationally and around the world.

Professor Glotzer is a leader in developing and applying computational approaches to materials problems. Her research focuses on computational approaches to nanoscale systems, complex fluids and soft materials, with an emphasis on elucidating fundamental principles of assembly and ordering processes. She has authored more than 60 papers, edited several conference proceedings, and presented more than 70 invited talks at universities and national and international conferences and meetings. She is well known for her discoveries in the areas of spatially heterogeneous dynamics in liquids and glasses, and controlling mesoscale structure in polymer blends.

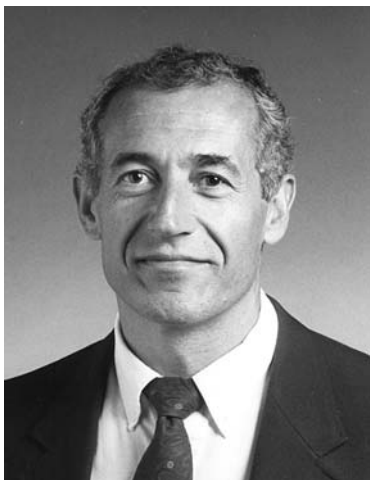
Erdogan Gulari

David Smith

Erdogan Gulari was born in Erzincan, Turkey. As a student in Robert's College he obtained his bachelor's degree in chemical engineering in 1969 and came to the California Institute of Technology to study towards the Ph.D. degree under the direction of Prof. Cornelius J. Pings. His dissertation, *A Laser Light Scattering Investigation of Transport and Critical Phenomena in Liquids* was published in 1973. After working as a postdoctoral fellow with Prof. Benjamin Chu at the State University of New York at Stony Brook, he returned to Turkey to build and manage vegetable-oil plants with his close friend Halis Komili. However, academia attracted Erdogan back to the U.S.A. in 1976. After working for two more years as a postdoctoral research fellow with Prof. Chu at SUNY Stony Brook, he came to the University of Michigan in 1978.

Erdogan was a pioneer in laser light scattering investigations of colloidal solutions. Since then his research interests have broadened to include heterogeneous catalysis and electronic materials. He has chaired or co-chaired the work of 31 doctoral students, a good fraction of whom have gone on to become chemical engineering faculty in the U.S.A. and around the world. Topics studied are divided almost equally between catalysis and biotechnology.

Erdogan has been recognized many times for the excellence of his research, his mentoring of students, and his service. He has received the Engineering College Excellence in Research Award in 1984, the Faculty Recognition Award of the University in 1985, the Departmental Research Excellence Award in 1994, the College Excellence in Service Award in 1995, the Chemical Engineer of the Year award of the Detroit Chapter of AIChE in 1990, the ASEE AT&T Foundation Award for Excellence as an Engineering Educator in 1989, and the Outstanding Teacher and Leadership Award of the Phi Lambda Upsilon's Delta Chapter in 1981.

In addition to being a full-time faculty member of the department, Erdogan also served as the senior associate dean of the Engineering College from 1986 to 1993.

Erdogan is an avid windsurfer, sailing both competitively and for fun. He spends most of his vacation time in Kauai enjoying the wind, the waves, and the nature around. His other hobbies include hiking, traveling, and reading anything he has within his reach.

Ronald G. Larson

David Smith

Prof. Larson was hired into the Chemical Engineering Department at the U–M in October 1996. Until then, he had been a member of the research staff at Bell Laboratories in New Jersey, now owned by Lucent Technologies. His bachelor's, master's, and Ph.D. degrees were all in chemical engineering from the University of Minnesota during 1971–1980. Since graduation, his research interests have been in the area of fluid mechanics, transport, polymer flow and rheology, and the structure and flow properties of “complex fluids.” Complex fluids include polymers, liquid crystals, colloids, surfactant solutions, and other substances whose properties are intermediate between those of liquids and those of solids. Useful complex fluids include foods such

as mustard or mayonnaise, biological fluids such as blood and mucin, personal-care products such as toothpaste and shaving cream, molten plastics used to make compact disks and garbage bags, and electronic materials such as liquid crystals and solder pastes.

Since arriving at Michigan, Prof. Larson has developed a new graduate course on complex fluids, which has drawn interest from students in chemical engineering, mechanical engineering, materials science and engineering, macromolecular science, and physics. For this course, he uses his book, *The Structure and Rheology of Complex Fluids*, published by Oxford University Press in 1999. He has begun a research program with a concentration in four new areas:

1. The flow properties and micromanipulation of biological polymer molecules such as DNA, important because of the growing fields of genome analysis and bioengineering.
2. The rheological properties of commercial polymers having branched architecture. Such polymers include many polyethylenes that are molecularly designed to optimize their final properties, including high strength, optical clarity, etc., but also to optimize the ease with which they are blown, spun, molded, or extruded into final useful forms.
3. The rheology and flow properties of immiscible polymer blends.
4. The structure of surfactant solutions and of biological surfactant (or “lipid”) layers containing proteins.

He has also continued his research efforts in other complex fluids such as liquid crystals, liquid crystalline polymers, surfactant solutions, and colloidal dispersions.

Prof. Larson has been active in the interdisciplinary Macromolecular Science Program. He is a member and former president (1997–1999) of the Society of Rhe-

ology (receiving their Bingham Medal in 2002), a fellow of the American Physical Society, a recipient of the Alpha Chi Sigma Award of the AIChE, and the G.G. Brown Professor of Chemical Engineering at the U-M. He is a member of the AIChE, the American Physical Society, the American Chemical Society, the Materials Research Society, the American Association for the Advancement of Science, and the American Scientific Affiliation. He is married to Beatrice Larson, and has (as of 2002) four children: Rachel (13), Emily (12), Andrew (11), and Eric (8).

Prof. Larson was appointed to a five-year term as chairman of the department, starting in September 2000.

Jennifer J. Linderman



Prof. Linderman joined the department in 1989. The research in her group centers around understanding the biochemical and biophysical mechanisms used by cells to sense, respond to, and interact with their surroundings. An ability to understand and manipulate these mechanisms is thus crucial to many areas of modern biotechnology, including cell and tissue engineering as well as pharmaceutical development. Receptors, specialized glycoproteins embedded in cell membranes, are responsible for much of the communication between a cell and its environment. Receptors have high-affinity binding sites for molecules termed ligands (e.g. hormones, antibodies, drugs) in the cell's local environment. The binding of a ligand to its receptor can result in signal transduction, the translation of the binding event into an intracellular sequence of messages and an eventual cell response. Thus the focus in Professor Linderman's group is on understanding and manipulating receptor-mediated cell behavior. In particular, she and her students work to quantitatively relate receptor-ligand binding, movement of receptors and ligands through the cell, and receptor signaling to cellular responses.

Eleven students have completed their doctorates under Professor Linderman's direction. Their dissertations, although all in some way concerned with cell receptors, have covered topics related to immunology, cell adhesion, and the quantitative analysis of signal transduction pathways. In addition, Professor Linderman has co-authored (with D. Lauffenburger) a text, *Receptors: Models for Binding, Trafficking, and Signaling* (Oxford Univ. Press, 1993).

Professor Linderman has developed two new graduate courses, ChE 510, *Applied Mathematical Methods*, and ChE 616, *Analysis of Chemical Signaling*, and has co-developed ChE 518, *Engineering Fundamentals in Biological Systems*, with

other members of the department. She won the College of Engineering Teaching Excellence Award (1997) and a Faculty Recognition Award (1996), was an NSF Presidential Young Investigator, and was elected as a fellow of the American Institute for Medical and Biological Engineering (2000).

Robert A. Lionberger



Bill Wood

Robert Lionberger joined the department as an assistant professor in September of 1998 after post-doctoral research at the University of Melbourne and Princeton University. He received a B.S. degree in chemical engineering from Stanford University in 1990, where he was named the Outstanding Senior in Chemical Engineering. He spent one summer with the Shell Development Company before pursuing his Ph.D. at Princeton University. His doctoral dissertation work with Bill Russel, entitled *Rheology, Structure and Diffusion in Concentrated Colloidal Dispersions*, involved developing integral equation theories and numerical methods to connect interparticle interactions and hydrodynamic interactions with the suspension microstructure under weak flows, and hence to predict the steady low-shear viscosity, the high-frequency modulus, and the linear viscoelastic spectrum.

At Princeton, this work was recognized through the award of a Princeton University Honorific Fellowship—one of ten awarded to the top final-year graduate students in the whole university. Also at Princeton, Rob received the Department of Chemical Engineering's Second Proposition Award for the best research proposal in an area differing from his thesis, and entitled *Dynamics of Spherical Microphases in Block Copolymers*.

After Princeton, Rob did postdoctoral work in the Department of Mathematics at the University of Melbourne as part of the Advanced Mineral Products Research Centre. At Melbourne, he continued his work on the theoretical description of colloidal materials, including a new model for shear-thinning of concentrated colloidal suspensions and predictions of the viscosity of bimodal and polydisperse colloidal dispersions from multicomponent integral equations. While in Australia, Rob also began to integrate the use of computer simulation into his research on complex fluids. He first employed the Stokesian dynamics method for simulations of hydrodynamic interactions in concentrated bimodal suspensions and then developed computer simulations to predict the yield stress of strongly aggregating dispersions.

At Michigan, Rob's research group studies the properties of complex fluids, which are materials containing supramolecular structures or aggregates and include colloids, suspensions, emulsions, and polymer networks. These materials form a vast range of microstructures whose properties are important for understanding many commercial and biological processes. Through theoretical analysis, the development of new simulation techniques, and large-scale computation, his research group designs novel materials and predicts the dependence of macroscopic properties on processing history and microscopic interactions. Applications of this research include predicting the effect of crystal structure on the properties of nanoparticles used to deliver pharmaceuticals, designing the structure of new associating polymers that can be added in small quantities to adjust the flow properties of water-based paints, and understanding how the forces between colloidal particles can cause a material to transform from a liquid to a solid. The research group uses a wide range of equilibrium and nonequilibrium simulation techniques including molecular dynamics, Monte-Carlo methods, Brownian dynamics, Stokesian dynamics, and dissipative particle dynamics for these applications. During winter 1999, Rob taught a graduate course in statistical thermodynamics and is beginning his undergraduate teaching in both the separations and thermodynamics courses.

Susan M. Montgomery



David Smith

Dr. Susan M. Montgomery joined the faculty in September 1993. She is an alumna of our department, and received a Ph.D. from Princeton University in June 1991, where her dissertation, *Quantifying Structural Variations in Fibrous Networks from Radial to In-Plane Behavior*, was with Prof. Ludwig Rebenfeld, president of the Textile Research Institute. Prior to her position here at Michigan, Dr. Montgomery worked as a postdoctoral fellow on a project with Prof. Scott Fogler, supervising the development of interactive computer modules for undergraduate chemical engineering courses. This project resulted in two dozen modules spanning the introductory, fluids/transport, separations and kinetics disciplines; these modules were distributed

to all chemical engineering departments in the country.

In addition, Dr. Montgomery and Prof. Fogler collaborated on the development of interactive computer modules on problem-solving techniques to supplement Scott Fogler's and Steve LeBlanc's new freshman book, *Strategies for Creative Problem Solving*. Dr. Montgomery later directed the Multimedia Education

Laboratory, producing among other multimedia materials a CD-based *Visual Encyclopedia of Chemical Engineering Equipment*. She currently serves as a lecturer and undergraduate program advisor, as well as faculty advisor to the student chapters of the Society of Hispanic Professional Engineers, and the American Society for Engineering Education.

David J. Mooney

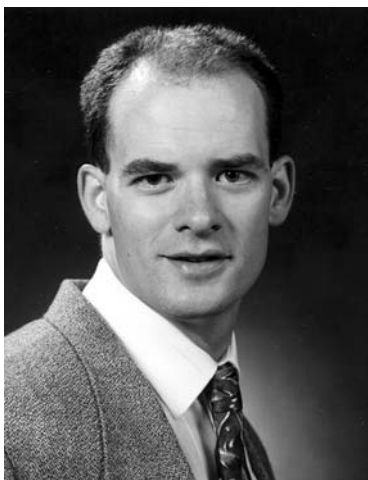

D.C. Goings

David Mooney came to the U–M and joined our faculty in September 1994 as an assistant professor. He has a joint appointment in the Department of Biologic & Materials Sciences in the Dental School. David received a B.S. with highest distinction from the University of Wisconsin, and subsequently received a Ph.D. from the Massachusetts Institute of Technology. He was a research fellow in the Surgery Department at Harvard Medical School for two years, where he worked with Joseph Vacanti and Robert Langer. The basic science question driving David's research program at Michigan is "how do signals, chemical and mechanical, transduced to cells via their adhesion to synthetic and natural materials, regulate cellular gene expression

and organization into tissue structures?" The information resulting from these studies is applied in the design and fabrication of synthetic polymer matrices that are used to transplant cells and engineer new tissues. These materials will serve as cell-transplantation vehicles, and as templates guiding tissue formation. This work is motivated by the large number of patients who currently die or survive on suboptimal therapies due to a lack of tissue available for transplantation. Specific research projects run the gamut from cell-based to biomaterials synthesis projects, but the goal common to all of these studies is to develop an understanding of cell-substrate interactions that can be exploited in the design of materials for medical use.

Phillip E. Savage

Phil Savage began working in the department as an assistant professor in fall 1986. His classroom teaching deals with thermodynamics, kinetics, reaction engineering, catalysis, and process design. At Michigan he has taught several undergraduate courses: *Thermodynamics I* (ChE 230), *Thermodynamics II* (ChE 330), *Reaction Kinetics and Reactor Design* (ChE 344), *Applied Chemical Kinetics* (ChE 444), and *Chemical Process Simulation & Design II* (ChE 487). His graduate

courses have been *Chemical Reactor Engineering* (ChE 528) and *Industrial Catalysis* (ChE 628). Phil also co-teaches two continuing-education courses: *Reaction Engineering and Applied Catalysis* with Levi Thompson, and *Reaction Kinetics for the Practical Engineer* with Fred Helfferich, from Penn State University.

Phil is also active in teaching outside the classroom. He has chaired or co-chaired ten Ph.D. committees, and he has worked with more than 60 undergraduate students in research projects. Thirteen of these undergraduates have become co-authors on research articles that described their work, and one (Doug LaDue) won the Andrew A. Kucher award from the College of Engineering for excellence in research by an undergraduate student. Phil's accomplishments in teaching have been recognized throughout the University of Michigan. The student members of Tau Beta Pi, the engineering honor society, presented him with their Outstanding Teaching Award in 1991. The Chemical Engineering Department awarded him its inaugural Teaching Excellence Award in 1992. The College of Engineering awarded him its Teaching Excellence Award in 1995. The University of Michigan named him a 1996 recipient of its highest honor for undergraduate teaching, the Amoco Faculty Teaching Award, and bestowed upon him an Arthur F. Thurnau Professorship in 1997. The American Chemical Society awarded Phil its national catalyst award in 2001, for teaching excellence in the chemical sciences.



David Smith

Phil has served the department, college, university, and profession in many ways. He has thrice been elected to a three-year term on the department's executive/advisory committee. He has also served on the undergraduate program committee and as an advisor to the AIChE student chapter and the Omega Chi Epsilon student honor society. Prof. Savage was elected to the College Curriculum Committee and to the Senate Assembly. He has also chaired both the College Nominating Committee and the Honors and Awards Committee. Phil served three years as treasurer of the Detroit local section of AIChE and he is active in planning programming for national AIChE meetings. Phil has also been a member of the editorial advisory boards of the journals *Energy and Fuels*, the *Journal of Supercritical Fluids*, and *Environmental Progress*, and he serves as an international editor for *Chemical Engineering Research & Design*.

Phil's research interests include chemical kinetics and mechanisms, and reaction engineering. His research contributions have provided a better understanding of hydrocarbon autoxidation and the thermal processing of heavy hydrocarbons, which is important in the conversion of coal or oil to liquid transportation fuels.

His more recent work focuses on chemical reactions in water at high temperatures and pressures (also known as supercritical water). Such reactions can be used to treat hazardous wastes and to minimize waste production. Prof. Savage's research group is providing engineering kinetics models that can be used to assess the economics of new "green" technologies and that are providing a more detailed, molecular-level understanding of the chemistry and physics of chemical reactions in supercritical water. In recognition of his group's research contributions, Phil received a College of Engineering Research Excellence Award in 1997.

Phil Savage earned his M.Ch.E. (1983) and Ph.D. (1986) in chemical engineering from the University of Delaware. He graduated with a B.S. (1982) in chemical engineering from Penn State, where he also met his wife, Elaine. They have three children (Bethany, Stephen, and Michael) and are active members of Grace Bible Church in Ann Arbor.

Johannes W. Schwank



David Smith

Johannes Schwank was born in 1950 in a small town near Innsbruck, Austria. From 1961–1969, he attended Stella Matutina, a private boarding school in the city of Feldkirch, near the Swiss border. After serving in the Austrian military for nine months, he studied chemistry at the University of Innsbruck, Austria, where he received his Diploma in 1975, and a Ph.D. in physical chemistry in 1978 with Prof. Hans Gruber as advisor. During this period, Johannes Schwank started to collaborate with Prof. Giuseppe Parravano, who spent his sabbatical leave from the University of Michigan at the Institute for Physical Chemistry at the University of Innsbruck. Schwank's thesis project dealt with infrared spectroscopic investigations of carbon monoxide adsorption on ruthenium and ruthenium-gold catalysts, a topic that had been suggested by Prof. Parravano. The success of this project prompted Prof. Parravano to invite Johannes Schwank to Michigan, supported by a Fulbright-Hays Scholarship. He arrived in Ann Arbor in March 1978, one month before Giuseppe Parravano's untimely death on April 1, 1978. Johannes Schwank and another postdoctoral scholar in Prof. Parravano's group, Dr. Signorino Galvagno, continued on with the catalysis research projects and helped the graduate students in the group to finish their thesis projects.

In 1980, the Chemical Engineering Department offered Johannes Schwank an assistant professorship. He was promoted to associate professor in 1984, and to professor in 1990. In 1987–1988, he held visiting professorships at the University of

Innsbruck and at the Technical University of Vienna, Austria, where he worked on a zeolite catalysis project with Prof. Johannes Lercher. From 1990–1995, Johannes served as chairman of the Department of Chemical Engineering at the University of Michigan.

His main research interests are heterogeneous catalysis, surface science, and thin films, with special emphasis on microelectronic thin-film gas sensors. He is the author of over 100 papers, and holds seven U.S. patents. He served as president of the Michigan Catalysis Society, and was the 1994 recipient of the Giuseppe Parravano Award for Excellence in Catalysis Research.

Johannes and his wife Lynne have four children, Alexander, Leonard, Hanna, and Rosa. The family lives in Ann Arbor, and maintains a second home in Austria.

Michael J. Solomon



U-M Photo Services

Michael Solomon's research interests are centered in the structure and rheology of complex fluids. Investigating the relationship between the two helps improve the liquid-state processing of polymeric and colloidal particulate materials. His group's research contributes to the engineering science necessary to improve the performance of processing operations such as injection molding, fiber spinning, film blowing, liquid film coating, electrophoresis, extrusion, and ceramic casting. His work uses static and dynamic light scattering, diffusing wave spectroscopy, x-ray scattering, rheology, and optical and epifluorescence microscopy. He is especially interested in developing methods to monitor the evolution of morphology and structure during the complex flows

typical of processing operations. Ongoing projects include the deformation of polymer coils in extensional flows, the microstructure and rheology of colloidal particulate gels, the dynamics of emulsions and immiscible polymer blends, the microscopic viscoelasticity of associating polymer solutions and the rheological properties of thermoplastic/clay nanocomposites.

Solomon has been teaching three undergraduate courses: *Fluid Mechanics* (ChE 341), *Thermodynamics I* (ChE 230) and a newly developed upper division elective, *Polymer Science and Engineering* (ChE 472). Four graduate students currently work in his research group. Solomon is departmental advisor for the Detroit Area Pre-College Spring Engineering Program.

Solomon joined the department as an assistant professor in September, 1997 after a post-doctoral research appointment at the University of Melbourne. He received his Ph.D. in chemical engineering from the University of California at

Berkeley in 1996 and his B.S. in chemical engineering and economics from the University of Wisconsin at Madison in 1990. He studied economics at the Université d'Aix-Marseille II from 1990–1991 while serving as a Rotary International Foundation Fellow. He enjoys running, cross-country skiing, backpacking, and winter camping.

Levi T. Thompson, Jr.

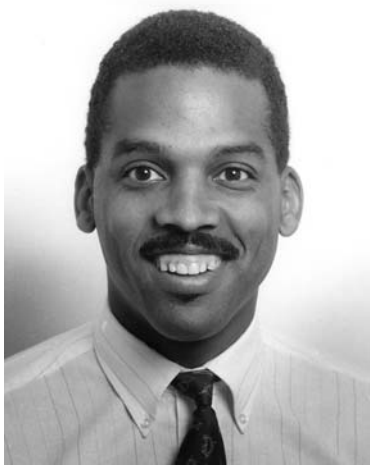

D.C. Goings

Levi Thompson is married to Maria Ann and is the father of Marissa Elena, 8, and Sabrina Elise, 6 (as of 2002). They presently live in Northville, Michigan. Levi grew up in Philadelphia with his mother and father, Naomi and Levi, Sr., and brother, Marvin. While he was in high school at The Christian Academy, Levi was very involved in athletics, earning letters in basketball, track, soccer and baseball. He was among the top basketball players in the Philadelphia area and remains the all-time leading scorer at his high school. He graduated second in his class and accepted a scholarship to attend the University of Delaware. While at the University of Delaware he majored in chemical engineering and played on the basketball team for two seasons. At

the University of Michigan, Levi earned master's degrees in chemical engineering and nuclear engineering, and a Ph.D. in chemical engineering. Working with Profs. Johannes Schwank and M. David Curtis, Levi focused on the evaluation and characterization of sulfide cluster-derived catalysts.

After graduation from the U–M, Levi accepted a position at KMS Fusion Inc., a company that was a key player in the development of inertial confinement fusion technologies. During his two years at KMS, Levi also served as an adjunct professor at the U–M. In 1988 he accepted a tenure-track position in the Department of Chemical Engineering. Levi's expertise is in the areas of catalysis, materials synthesis, and electrochemistry. Research in his group fuses traditional themes in chemical engineering and materials science with the emergent one of rational design. Of special interest are metal nitrides and carbides, aerogels and amorphous and metastable materials with controlled compositional and microstructural properties. Levi has received several awards including the National Science Foundation Presidential Young Investigator Award, the Tau Beta Pi Outstanding Teaching Award and the College of Engineering Research Award, and has given many invited lectures including the keynote lecture to the South African Catalysis Society. He recently spent his sabbatical leave as a visiting professor in the Department of Chemical Engineering at the University of California, Berkeley.

Levi is very active in the U–M and Ann Arbor communities. He has been faculty advisor to the U–M chapter of the National Society of Black Engineers and the National Organization of Black Chemists and Chemical Engineers, and chair of the College of Engineering Safety and Rules Committees. Levi also served as president of the Michigan Catalysis Society and the alumni chapter of Alpha Phi Alpha Fraternity, Inc. With his family, he is a member of Bethel AME Church in Ann Arbor.

Henry Y-N. Wang



David Smith

Henry received his B.S. in chemical engineering at Iowa State University in 1972 and his S.M. and Ph.D. in biochemical engineering from the Massachusetts Institute of Technology in 1977. He then worked as an engineering associate at Merck & Co. and as a senior scientist at Schering & Plough before joining the Department of Chemical Engineering at the University of Michigan in 1979. In addition to chemical engineering, Henry currently also holds a joint appointment in the Department of Biomedical Engineering. In chemical engineering, he inherited from Professor Lloyd Kempe a highly successful undergraduate bio-option program, with an annual enrollment of at least 20–30 students, many of whom have since become leaders in the pharmaceutical and biotechnology industries. In addition to the regular chemical engineering curriculum, the option required microbiology and biochemical engineering courses that were offered in the College of Engineering, an unusual arrangement at that time. The option was discontinued in 1989—ironically at the same time that many other departments decided to move into biotechnology.

Henry has now been in charge of the first undergraduate chemical engineering laboratory course (ChE 360) for a few years. Here, he has introduced a structured team oral-presentation format and other technical writings such as SOP into the course, which now emphasizes team work, technical communication, time management, technical knowledge, and critical thinking.

Henry's research interests are primarily in biochemical engineering, and require a fundamental understanding of cellular and molecular biotechnology as well as chemical engineering principles. His early research included computer control of bioprocesses and extractive fermentation processes, with a particular emphasis on the fundamental understanding of cellular toxicity in the presence of liquid solvents and solid adsorbents. His more recent research focuses primarily on the use of bioprocessing for sustainable development. He investigated the development of

liquid fuels such as ethanol from biomass and continuous biodiesel production using transgenic oil seeds. Recently, his team has designed a new mobile photobioreactor system for high-density plant cultivation and phytochemical production to help reduce greenhouse-gas emissions. His research group is also involved in designing and synthesizing new co-immobilized delivery systems for various environmental applications such as mixed wastes bioremediation as well as environmentally benign approaches to controlled release and delivery of pesticides and other bioactive molecules.

Recently, Henry and others have formed a new research and training program in pharmaceutical engineering, initially involving a new interdisciplinary degree program, M.Eng. in pharmaceutical engineering. The program will be administered by InterPro, the new administrative unit within the College of Engineering that supports interdisciplinary professional programs. Working with Professor Nair Rodriguez of the College of Pharmacy, Henry will be the engineering director of the program, which has strong industrial support and will have at least 25–30 full- and part-time students enrolled within two years. A key characteristic of the program is the incorporation of practical training within the curricula of the enrolled students, who are required to spend time in the form of summer internships during their years at the University of Michigan. Henry and his colleagues are also developing several distance-learning courses and a video seminar series for this pharmaceutical engineering program.

Ralph T. Yang



David Smith

Ralph T. Yang served as chairman of our department from 1995–2000, after being on the faculty at the State University of New York at Buffalo for 17 years, the last six years as the chairman of their Chemical Engineering Department. Born in China, Yang received his B.S. degree from National Taiwan University, and M.S. and Ph.D. degrees from Yale University. Besides SUNY at Buffalo, Prof. Yang's professional experience included stints at Alcoa, Brookhaven National Laboratory, and the National Science Foundation. The topics of Yang's current research include new adsorbents and new applications for separations using weak chemical bonds (particularly pi-complexation), field-assisted adsorption and desorption phenomena, novel catalysts for selective catalytic reduction of nitric oxide with ammonia, selective trap for nitrogen oxides, hydrogen storage in carbon nanotubes, and application of molecular orbital theories to chemical engineering problems.

Yang has published 302 refereed journal articles and holds 15 U.S. patents. He is also the author of the book *Gas Separation by Adsorption Processes*, published by Butterworth in 1987, and its paperback version by Imperial College Press in 1997. The book has been translated into Chinese, Korean, and Russian. Yang has developed and taught a new graduate course, *Adsorption Engineering*, using his book as the main text. Professor Yang has received three major awards from the AIChE: the 1991 William H. Walker Award for Excellence in Contributions to Chemical Engineering Literature, the 1996 Institute Award for Excellence in Gases Technology, and the 1997 Clarence Gerhold Award (Separations Division Award). He was also honored with the 1999 SGL Carbon Award from the American Carbon Society for the “most significant overall contributions to the science or technology of carbon.” Most recently, he received the 2001 Award for Advancement of Basic and Applied Science from the Yale University Science & Engineering Society. Then, in 2002, he became the Dwight F. Benton Professor of Chemical Engineering at the U-M.

Yang’s present and past professional activities include serving on the advisory boards of the International Adsorption Society, *Industrial and Engineering Chemistry Research* (an ACS Journal), *Adsorption Science & Technology*, *Adsorption* (the journal of the International Adsorption Society), *Applied Catalysis, B—Environmental, Separation & Purification Methods, Carbon*, and the Imperial College Press, for which he serves as the editor of the Chemical Engineering Series.

Robert M. Ziff



David Smith

Robert Ziff was born January 28, 1951 in the San Fernando Valley of Los Angeles. His father was in the real-estate business after a stint as a comedy writer in radio and early TV in Hollywood. He grew up hobbying in electronics and other mechanical things with his brother, who went on to a career in film special effects and, subsequently, investing. He also has a sister who moved to New York to be an artist, and remains there. His mother was a homemaker and also worked in a VA hospital. Robert Ziff studied physics as an undergraduate at UCLA, working in a laboratory studying liquid helium. For graduate work, he went to New York City to study statistical thermodynamics and kinetic theory with a renowned group composed of George Uhlenbeck, Mark Kac, and E.G.D. Cohen at the Rockefeller University. Uhlenbeck, the co-discoverer of the spin of the electron, had in fact been at Michigan from about 1927 to 1961, and often talked about Ann Arbor and what it was like in the 1920s

for a young man from Leiden, The Netherlands. Uhlenbeck studied under Paul Ehrenfest who in turn had studied under Ludwig Boltzmann (1844–1906).

Robert Ziff’s graduate work was on Bose-Einstein condensation, which at that time was considered completely academic but is now the “hottest” thing in atomic physics with the attainment of really low temperatures. He subsequently worked in two post-doctoral positions, in Los Alamos (cryogenic group) and the State University at Stony Brook (in the mechanical engineering department), where his interests moved to problems in aggregation, polymerization, and liquid-state theory—problems of interest to chemical engineers. This led to his joining the Chemical Engineering Department at the U–M in 1982, the same year that he married Sofia Merajver. They raised her daughter Vera here in Ann Arbor—she went on to the University of Chicago and Emory Law School—and had two more children, David (1987) and Anna (1993), who is 19 years younger than her older sister Vera. David and Robert enjoy riding their tandem bike in the environs of Ann Arbor. Sofia, whose background was originally statistical physics like Robert’s, went to the Medical School at Michigan and is now a professor of internal medicine (oncology).

RECENT CHEMICAL ENGINEERING FACULTY

Dale E. Briggs



David Smith

Prof. Briggs earned his B.Ch.E. degree from the University of Louisville in June 1953 as a NROTC student and was commissioned as an ensign, USN. He served four years on active duty. Prof. Briggs came to the department to enter the graduate program in late June 1957, having been an assistant professor of naval science in the NROTC program at the University of Michigan from July 1955 to June 1957. He joined the Wolverine Tube heat-transfer project headed by Prof. Ed Young in late June as a research assistant. He began teaching as a teaching fellow in September 1958, working with Prof. Brymer Williams in Chem-Met 2. The research work in heat transfer led to many great opportunities and experiences since the work on extended-surface heat transfer for liquid-phase heat transfer, condensation, and for air-cooled heat transfer was on the forefront of industrially needed heat-transfer results. As a result, Prof. Briggs was elected to the Board of Directors of the Heat Transfer and Energy Conversion Division of the American Institute of Chemical

Engineers while he was still a graduate student. He later became chair of the division. He also consulted for industry in heat transfer.

Prof. Briggs was appointed as an instructor in 1961 while working on his Ph.D., which was completed in 1968, when he was promoted to an assistant professor. He was assigned to teach the undergraduate and graduate courses in equipment and process design in the early years and continued to teach in those areas through his tenure in the department. Prof. Briggs was the first to require undergraduates to use digital computers in chemical engineering course assignments. This occurred as soon as engineering undergraduates were required to complete a digital-computer class. He also collaborated in the teaching of separation processes with Prof. John Powers for a number of years. In the late 1960s Prof. Briggs rebuilt the ChE 460 laboratory after it had been moved from East Engineering to the G.G. Brown Laboratory, and was awarded a Distinguished Service Award for Junior Faculty in 1969. He served as the undergraduate program advisor from 1982 until 1997.

Prof. Briggs' research changed directions in 1973 when he and Prof. Katz undertook a project in separating the minerals from solvent-refined coal. That research led to a short, but very successful project with the newly formed Electric Power Research Institute. The project involved the review and site visit of some 33 industrial and governmental laboratories doing research and development work on converting coal to clean fuels for the electric-power industry. Success on the project led to a 14-year consulting arrangement with Consumers Power Co. The activities with Consumers Power were advantageous in relation to teaching courses in air pollution control, separation processes, and process design. The coal-related research lasted until the undergraduate enrollment increased to a point where the counseling and teaching assignments took his total effort.

Prof. Briggs was on many university faculty committees, including SACUA, the Board of Control of Intercollegiate Athletics, and the College Curriculum Committee (of which he was the chair for two years). He chaired the Environmental Sciences Engineering program for four years and it became an accredited engineering program during his tenure. He served as the Chief Marshal of University Events from September 1990 until May 1999.

Prof. Briggs retired from the university on May 31, 1999.

Brice Carnahan

Brice attended Case Institute of Technology, obtaining his B.S. (1955) and M.S. degrees (1956) in chemical engineering, with a minor in nuclear engineering. He did his Ph.D. (1965) research on radiation-induced cracking of paraffins at Michigan, with Joe Martin as advisor. His collaborations with Don Katz from 1959–1965, as technical director of the Ford Foundation project, *Computers in Engineering Education*, and then as associate director of the NSF project, *Computers in Engineering Design Education*, firmly established Brice's interests in comput-

ing, numerical methods, and process design and simulation. Brice co-authored *Applied Numerical Methods* (1969), beginning a collaboration with Jim Wilkes that spanned more than 35 years. For extended periods since 1967—and continuously from 1981 to 1997—the two were responsible for organizing and supervising digital-computing courses for all (perhaps as many as 30,000) engineering freshmen at Michigan. Twenty-seven different editions of their two course texts were published over the years.



Since joining the faculty at Michigan in 1960, Brice has been at the forefront of computer applications and computing education in chemical engineering. From 1960–1985, he presented a popular series of evening lectures on computer programming, typically attended by about 300 students, faculty, staff, and others. In the department, Brice taught courses on numerical and optimization methods, computer-aided process design, and material and energy balances. His research interests have focused on algorithm and software development for computer-aided design, particularly for dynamic process simulation, and most recently on decomposition, numerical, and coordination algorithms suitable for solution of large-scale dynamic chemical process

models in distributed-memory parallel-computing environments.

Brice served as chair of the department's Graduate Committee for a record 20 years of the 25-year period 1975–2000. He was elected to the College Executive Committee for a four-year term from 1979–1983, and served from 1983–1993 as a member of the Executive Committee of CAEN, the computing network in the Engineering College. On the national scene, Brice was a founding member and first interim chairman of the CACHE (Computer Aids for Chemical Engineering Education) Committee and later Corporation. He subsequently served as CACHE vice-chairman and chairman (1974–1975), and is currently a board member and publications chairman. He has been active in the AIChE, most recently serving as editor of seven AIChE Symposium Series volumes since 1993. He has held several elected AIChE positions, including chairmanship of the CAST (Computer and Systems Technology) Division in 1981–1982, and was a member of the editorial board of *Computers and Chemical Engineering* from 1978–1998. He is an elected fellow of the AIChE.

Brice has received numerous citations for his dynamic style of teaching and service, including the Class of 1938 Service Award (1963), the University of Michigan Outstanding Service Award (1968), awards from the University of Michigan Engi-

neering College for Excellence in Teaching (1983) and Excellence in Service (1993), and the award for Outstanding Teaching (1998) in the department. Nationally, he has been recognized with the AIChE Computing in Chemical Engineering Award (1980), the Detroit Engineering Society Award as Chemical Engineer of the Year (1987), and the ASEE Chemical Engineering (3M) Lectureship (1991). Brice has been a chemical engineering faculty member at the U-M since 1960, with brief stints as a visiting faculty member at the University of Pennsylvania, Imperial College (London), and University of California at San Diego. He retired in June 2001.

Rane L. Curl

Rane L. Curl, professor of chemical engineering, retired from active faculty status on December 31, 1997, following an exemplary and productive career. Professor Curl received his S.B. (1951) and Sc.D. (1955) degrees in chemical engineering from the Massachusetts Institute of Technology. Following employment by the Shell Development Corporation and Technische Hogeschool Eindhoven in the Netherlands, he came to the University of Michigan in 1964 as associate professor of chemical engineering. He was promoted to professor in 1969. As a teacher, Professor Curl enhanced the curriculum by improving existing courses and introducing new ones. In the last decade he introduced an important change in the senior laboratory course. From a set of perfunctory separate experiments, the course has evolved into one in which real problems are simulated and experiments are performed that lead to their solution. The course also emphasizes laboratory safety and environmental protection.



David Smith

Professor Curl's research and more than 70 publications pursue the explanation of commonly accepted, but incompletely understood, phenomena in fields ranging from industrial processes to medicinal chemistry. A large portion of his research is his life-long study of caves and karsts, where his work has extended far beyond the interests of a pure naturalist into the application of the new field of fractals to the explanation of geological characteristics. He has been a force in the development of the National Speleological Society as a true professional organization, serving as its president and in other administrative positions. Within the department, Professor Curl established and chaired the Safety Committee, making him a leader in recognizing the need for introducing environmental and safety concerns into the educational process. His colleagues and students will remember his clear enunciation of the con-

sistently high standards of performance expected in his classes and in graduate research.

Francis M. Donahue

Frank Donahue came to the U–M in 1965 from UCLA, where he had just received his Ph.D. in engineering after “industrial stints” at Tasty Baking Company, Betz Laboratories, and Stanford Research Institute. His undergraduate training was in chemistry at LaSalle College, where he graduated with a B.A. He retired from the U–M in 1996. His main research interests centered in the areas of electrochemistry and electrochemical engineering, with particular emphasis in corrosion processes addressing fundamental metal/oxidized-metal reactions that were spontaneously coupled with environmental reduction reactions. This work moved him in two somewhat different, but fundamentally related, directions, viz., electroless plating (establishment of a new metallic surface without the use of electrical current) and battery technology.



David Smith

In the case of electroless plating Frank was one of the first proponents of the mixed potential theory approach to the problem with extensive developments in terms of the electrochemical kinetics of the partial processes, an elegant analysis of the nature of interactions between (and among) the partial reactions and their role in the overall process, an elucidation of the role of in-situ gas evolution on mass transport of the metal ion in electroless copper plating (for printed circuit boards), and an exposition of the chemically controlled anodic partial reaction in electroless nickel plating. The work in battery technology—which continues even in retirement—began with the study of ambient-temperature molten-salt electrolytes that had the

interesting property of being reversible to aluminum metal (which led to studies in aluminum electrorefining as well as the battery work). On the basis of some fundamental computations of available energy density, studies were carried out with aluminum and zinc negative electrodes and iron (III) chloride and copper (II) chloride positive electrodes. For various reasons, only aluminum–iron (III) chloride secondary (rechargeable) batteries were constructed and tested. In retirement, Frank has continued his forays into battery technology, with special interest in secondary batteries under unusual conditions, e.g., abuse (low-rate battery in a high-rate application), recovery from overcharge or overdischarge, thermal behavior in near-adiabatic situations, etc.

While on the faculty, Frank Donahue taught graduate courses in electrochemical engineering, corrosion engineering, and mass transport. In addition, he taught nearly all of the required undergraduate courses as well as serving stints as undergraduate program advisor and graduate admissions advisor. He was also a regular contributor to continuing education courses at the U–M. After an initial effort at UCLA in 1967, he offered an electrochemical engineering course annually from 1968 through 1991 at the U–M’s Engineering Summer Conferences. Since then, he has continued to offer that course (and technology-based courses) through his consulting/training company, Minotaur Technologies.

Robert H. Kadlec



Robert H. Kadlec joined the faculty of the Chemical Engineering Department at the University of Michigan in September, 1961, immediately after he completed his doctoral work with Prof. Brymer Williams. His initial teaching assignments were in rate operations, in which he collaborated with Prof. Stuart Churchill and other faculty. He developed and taught undergraduate and graduate courses in process control; and, together with Drs. Grant Fisher and Martin Javinsky, assembled and taught the department’s first process-control laboratory. Bob’s greatest teaching interest was for mathematical modeling, which he pursued for three decades. He developed several levels of modeling courses, with emphasis on modeling thought processes rather than on equations.

As needed, Bob also taught over twenty other graduate and undergraduate courses; and received the College of Engineering’s Teaching Excellence Award in 1988. Prof. Kadlec’s research interests varied from process dynamics and optimization, to novel chemical reaction systems, to periodic process operation, and finally environmental transport phenomena. Plasma-arc reactions at 20,000°F and nuclear radiation photochemical reactors were representative of research at extreme conditions. He initiated pioneering research in periodic separation and reaction processes, such as pressure-swing adsorption with reaction and cyclic pyrolysis. Twenty-one of Prof. Kadlec’s doctoral students were involved in these traditional ChE pursuits.

For nine years in the decade of the 1970s, Bob was editor of the *AIChE Journal*. Bob’s final six doctoral students worked on environmental modeling of wetland reactors. Beginning in 1969, Bob developed a major interest in the application of chemical engineering principles to the description of vegetated aquatic environments. In 1975, he and his students designed and built the first wetland water

treatment system in the U.S.A. This award-winning system was still functioning well 20 years later. Over those years, wetland treatment technology grew, and Professor Kadlec's research continued. In 1992, he was elected chair of the treatment wetlands section of the International Association for Water Quality. In time, the demands of external wetlands research and consulting proved too great, causing him to retire from university duties in 1995. This did not stop his pursuit of academic challenges; for during the three years after "retirement," he authored 23 technical papers and a comprehensive text, *Treatment Wetlands*.

Lloyd L. Kempe



Lloyd L. Kempe, professor of chemical engineering and professor of microbiology, retired from the University of Michigan on May 31, 1981, after a distinguished career devoted to the development of academic and research programs in biochemical engineering. Born in Pueblo, Colorado, Professor Kempe grew up in St. Paul, Minnesota, where he attended high school and enrolled in the University of Minnesota. He received a B.S. in chemical engineering in 1932 and went on to work for the Minnesota Department of Health and simultaneously obtained an M.S. in public health engineering from the University of Minnesota in 1938. He first joined the University of Michigan as a research associate in the Department of Bacteriology, 1940–1941.

During the Second World War, he served on active duty in the Southwest Pacific, achieving the rank of colonel in Artillery. His war career was distinguished by a rapid rise through the ranks to deputy chief of staff for Major General Marquardt, General MacArthur's artillery officer. Afterwards, he resumed his academic training at the University of Minnesota, receiving a Ph.D. in chemical engineering and industrial microbiology in 1948. He returned to the University of Michigan as an instructor in bacteriology in 1948. After a short appointment at the University of Illinois from 1950–1952, where he established their Food Engineering Program, he rejoined the University of Michigan in the Chemical Engineering and Bacteriology Departments as an assistant professor.

Professor Kempe was responsible for pioneering the development of the program in biochemical engineering at the University of Michigan in the late 1940s and early 1950s, predating similar efforts of many other universities by more than a decade. His foresight concerning the importance of microbiology in industry led a very active research and training activity that made the University of Michigan one of the leading centers in this field.

Professor Kempe's research contributions were of broad scope, covering the areas of safety in food processing, radiation and heat sterilization, lampricide use in the Great Lakes, and aeration of fermentors. He served on several state and national panels, including advisory committees of the National Research Council and the Food and Drug Administration. He was recognized internationally as an expert in the control of the dreaded food contaminant, *C. botulinum*, and was called on by the State of Michigan to help resolve crises involving botulism hazards.

John E. Powers

John ("Jack") E. Powers, professor of chemical engineering, retired from the University of Michigan on June 30, 1982 after a productive career as a teacher and researcher. Professor Powers took his undergraduate studies in chemical engineering at the University of Michigan, obtaining a B.S.E. in 1951. He was very active in the athletic program as an undergraduate and achieved outstanding recognition both in wrestling and football. He obtained his doctorate in chemical engineering from the University of California (Berkeley) in 1954. After two years with the Shell Development Company, he joined the faculty of the Department of Chemical Engineering of the University of Oklahoma (Norman). He was rapidly promoted and appointed as full professor as well as being selected to head the department from 1959 to 1961.

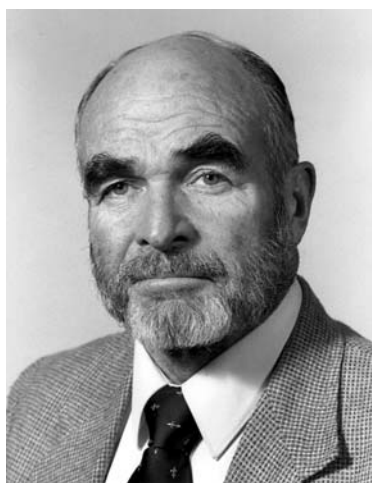

U-M Photo Services

Professor Powers rejoined the University of Michigan in 1963. He developed important research programs in separations and thermodynamics, resulting in about 60 publications during this period. His thermodynamics laboratory was unique, producing some of the most precise data yet achieved in the calorimetry of gases and liquids near the critical point. Professor Powers has made significant contributions to the teaching program in engineering education by the development of a unique problem-solving approach in the teaching of separations science and engineering. He was also very active in industrial consulting in various areas relating to energy resources. He currently lives near Moab, Utah.

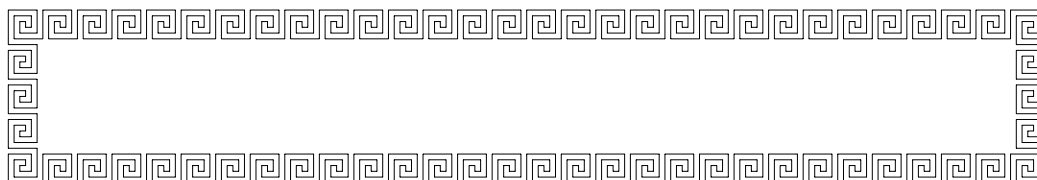

Maurice J. Sinnott

David Smith

Maurice (“Maury”) J. Sinnott, professor of chemical engineering and metallurgical engineering, retired from the University of Michigan on April 30, 1984, after an outstanding career as a teacher, researcher, and administrator. He was awarded all of his degrees from the University of Michigan: B.S. (chemical engineering, 1938). M.S. (chemical engineering, 1941), and Ph.D. (metallurgical engineering, 1946). He began his teaching career in 1944 at the University of Michigan as an assistant professor in the Department of Chemical and Metallurgical Engineering. He was promoted to associate professor in 1948, and to professor in 1954. As chairman for many years of both the departmental Doctoral Standards Committee and the Chairman’s Advisory Committee, Professor Sinnott helped guide the department’s growth and progress. From 1972–1981 he was associate dean (for administration and research) of the College of Engineering.

During a 1969–1971 university leave, Professor Sinnott served first as director of the Materials Research Office of the Defense Advance Research Projects Agency (DARPA), and then as deputy director of DARPA. He continued that professional affiliation; at the time of his University of Michigan retirement he was director of DARPA’s Materials Research Council, conducting research on campus during the academic year and organizing a two-month conference each summer. Professor Sinnott’s research interests included physical metallurgy, surface phenomena, and solid-state physics. He published two textbooks and 40 other publications in the areas of materials and physical metallurgy; his 1958 text, *The Solid State for Engineers*, was the first such textbook in the country. He introduced solid-state physics into undergraduate engineering courses and was the first to introduce computer methods to undergraduate metallurgical courses.

Professor Sinnott received the University of Michigan Distinguished Faculty Achievement Award (1969) and the American Society of Metals Bradley Houghton Award for Outstanding Teaching (1964). He was also awarded the Meritorious Civilian Service Medal (1972) by the U.S. Secretary of Defense for outstanding contributions in engineering and management, including the development of ceramics in gas turbines.

Professor Sinnott was a member of the American Society of Metals, the American Institute of Metallurgical Engineers, the American Society of Testing and Materials, and the American Society of Engineering Education. He currently lives in Ann Arbor with his wife Mary.

M. Rasin Tek

M. Rasin Tek, professor of chemical engineering, retired from the University of Michigan on May 31, 1986, after a very productive professional career. A native of Turkey, Professor Tek received his B.S.E. degree in 1948, his M.S.E. degree in 1949, and his Ph.D. degree in 1953, all from the University of Michigan. Following a three-year period as engineer and section manager for Phillips Petroleum Company in Bartlesville, Oklahoma, he joined the Department of Chemical and Metallurgical Engineering as assistant professor in 1957. He was promoted to associate professor in 1960 and to professor in 1965. Professor Tek has published over 120 papers and 15 books, mostly in various aspects of petroleum engineering. His papers have been published and reprinted in five countries and in three languages. He has had ten patents issued on work related to petroleum engineering. His two hardcover type-set books on underground storage are considered standard references in that field.

He is a Distinguished and Senior Member of the SPE. As an acknowledged leading authority in the underground storage of natural gas, he has served as a consultant and as a worldwide expert in evaluating the performance of natural gas fields. An important aspect of Professor Tek's activity has been his impact on the education of outstanding scientists. He initiated and taught courses in production and processing of petrochemicals for several hundred engineers, introducing them to the principles of reservoir engineering, processing, and storage of crude oil and natural gas. In addition, he was advisor for more than a dozen doctoral students, many of whom became leaders in the petroleum engineering field.

Professor Tek has had a considerable professional impact. He was consultant to over 60 companies and government agencies in 14 countries, including the United Nations, NATO, and the Executive Office of the President of the United States. He has taught at the University of New South Wales in Sydney, Australia, as a Fulbright scholar and later as a visiting professor. He has been a consultant to most major oil companies, public utilities, and storage companies in addition to law firms and universities. He currently lives in Hawaii with his wife, Gretchen.

Professor Tek has had a considerable professional impact. He was consultant to over 60 companies and government agencies in 14 countries, including the United Nations, NATO, and the Executive Office of the President of the United States. He has taught at the University of New South Wales in Sydney, Australia, as a Fulbright scholar and later as a visiting professor. He has been a consultant to most major oil companies, public utilities, and storage companies in addition to law firms and universities. He currently lives in Hawaii with his wife, Gretchen.

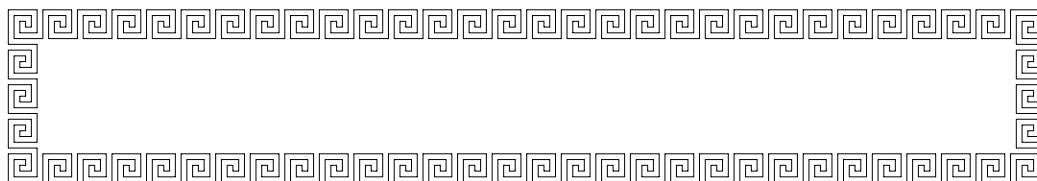

James O. Wilkes

David Smith

Jim Wilkes was born in Southampton, England. As a scholar of Emmanuel College, he obtained his bachelor's degree in chemical engineering from the University of Cambridge in 1955. The English-Speaking Union awarded him a King George VI Memorial Fellowship to the University of Michigan, from which he received a master's degree in 1956. He returned to England for four years as a faculty member at the University of Cambridge, coming back to the U–M in 1960 to study for his Ph.D. with Stuart Churchill. In 1963 he published his dissertation, *Finite-Difference Computation of Natural Convection in an Enclosed Rectangular Cavity*. He has been a faculty member at the U–M since 1960, retiring in 2000.

Jim was a pioneer in the numerical solution of partial differential equations, both by finite-difference and finite-element methods, and his research interests have always been in that area. He has chaired or cochaired the committees of 21 doctoral students, the great majority of whom have also engaged in experimental work in tandem with their numerical studies. Topics studied have ranged from two-phase flow, measurement of turbulent velocity fluctuations, natural convection, reservoir engineering, metal casting, and many aspects of polymer processing.

He has been recognized many times for his dedicated classroom teaching, being a first recipient in 1980 of the College of Engineering's newly instituted Engineering Excellence in Teaching Award. In 1987, he received the highest University of Michigan award for classroom teaching—the Amoco Good Teaching Award—and was named an Arthur F. Thurnau Professor from 1989–1992, an appointment that is based largely on undergraduate teaching evaluations. At the University of Michigan, Jim was department chairman from 1971–1977 and assistant dean for admissions in the College of Engineering from 1990–1994. He is editor of the Class and Home Problems section of *Chemical Engineering Education*, and was for 25 years associate editor for the U.S.A. of *Chemical Engineering Research & Design*. He has co-authored with his colleague and friend Brice Carnahan *Applied Numerical Methods* (Wiley, 1969), *Digital Computing and Numerical Methods* (Wiley, 1973), and numerous editions of two books used in the freshman engineering computing courses at the U–M, the most recent being *FORTTRAN for the Macintosh and IBM PS/2* (1994) and *The Macintosh, the PC, and Unix Workstations* (1996). His latest book, *Fluid Mechanics for Chemical Engineers*, with contributions by Stacy Bike, was published by Prentice-Hall in 1999. He is only the second living faculty member of our department to have a scholarship fund named after him.

Jim is the president of the Board of Trustees of Barton Hills Village outside Ann Arbor, where he lives with his wife Mary Ann. An amateur organist, he received his performance diploma, Associate of the Trinity College of Music (London), in 1951, and his American Guild of Organists Service-Playing Certificate in 1981. In 1995, he wrote and published a book, *Pipe Organs of Ann Arbor*, which describes about 75 instruments in the city's churches, colleges and universities, residences, cinema, and even a funeral parlor. He has produced this history of the U-M Chemical Engineering Department and is also working on his grandfather's manuscript, *Place-Names of Hampshire and the Isle of Wight*. Jim's other hobbies include hiking in North Wales, New Zealand, and the American West (he has visited Zion and Big Bend National Parks nine times each, and enjoys walking up the West Rim of Zion), an occasional game of tennis, gardening, and reading.

G. Brymer Williams



David Smith

G. Brymer Williams, professor of chemical engineering and metallurgical engineering, retired from the University of Michigan on May 31, 1984, after a most productive career as a teacher, researcher, and administrator. He received his B.S. degree in 1936 and his Ph.D. degree in 1949, both from the University of Michigan. Professor Williams' thirty-seven years of teaching were preceded by employment as a chemical engineer at the M.W. Kellogg Company (1941–1947). He was a consultant for nearly thirty years with Phillips Petroleum, Applied Automation, and other companies and governmental agencies. Before joining the University of Michigan chemical engineering faculty, he taught as an adjunct professor at New York University. He

was appointed as an instructor at Michigan in 1947, promoted to assistant professor in 1948, to associate professor in 1950, and to professor in 1956.

As our undergraduate program advisor, Professor Williams was instrumental in making the curriculum one of the most outstanding in the country. He served as the principal counselor to undergraduate students and guided them to successful completion of their academic studies. His devoted and conscientious approach to his work with students is remembered by alumni, and they are proud to regard him as their friend.

Professor Williams has played a major role in the university community. A few of the boards and committees on which he has served are the Hospital's Public Advisory Committee, the University Development Council, SACUA, the Senate Assembly (member and chairman), President Shapiro's Inaugural Committee, the

College Honors Committee, the Centennial in Engineering Education, and the Board in Control of Intercollegiate Athletics. He was a pioneer in developing the concept of unit operations in chemical engineering, which has influenced the teaching approach in this field for decades. His research activities have centered around petroleum engineering and have included the design of processes and systems, plant tests and optimization studies, regional natural-resource development studies, and development of energy-conservation programs. He is the first living faculty member of our department to have a scholarship fund named after him.

He is a registered professional engineer and a fellow of the American Institute of Chemical Engineers. Professor Williams is also a member of the American Chemical Society, the American Institute of Mining and Metallurgical Engineers, the American Society of Engineering Education, the Canadian Society of Chemical Engineers, the Colorado Mining Association, Sigma Xi, Tau Beta Pi, Phi Lambda Upsilon, and Phi Kappa Phi. He currently lives in Ann Arbor.

Gregory S.Y. Yeh



Greg Yeh, professor of materials and metallurgical engineering in the Department of Chemical Engineering, retired on 30 April 1998, following 31 years of service. He earned his B.S. degree in physics from Holy Cross College in 1957, his M.S. degree in engineering physics from Cornell University in 1960, and his Ph.D. degree in polymer physics from Case Institute of Technology in 1966. From 1960–1964, he worked as a research physicist at Goodyear Tire and Rubber Company and then as a senior research physicist at General Tire and Rubber Company. After completing postdoctoral studies at Case Institute of Technology in 1966, he joined our faculty as an assistant professor in 1967. He was promoted

to associate professor in 1969 and professor in 1972.

Prof. Yeh's work, documented in 80 scientific publications and numerous presentations at scientific meetings worldwide, spanned a wide range of timely topics, with emphasis on the morphology and kinetics of single and multiple polymeric systems and on solid-state polymer processing and deformation. He also made important contributions to the morphology and kinetics of strain-induced crystallization of polymers and to the elucidation of chain conformation in amorphous polymers. Prof. Yeh was twice a Fulbright Scholar, and he received a Humboldt Award three times. In Germany, he was a visiting professor at the University of Ulm, the Technical University of Berlin, and the Max Planck Institute in Berlin.

Later, he also served as a visiting professor at the University of California at Berkeley and the University of Technology, South China. Within the U-M College of Engineering, Prof. Yeh had an impact not only through developing and teaching polymer courses, but also through his role as advisor to 15 doctoral students.

Edwin H. Young



David Smith

Edwin H. Young, P.E., professor of chemical engineering and professor of metallurgical engineering, retired from the University of Michigan on May 31, 1989. Born in Detroit, Professor Young received his B.S. degree in chemical engineering from the University of Detroit in 1942. After serving in the United States Navy, he entered the University of Michigan, receiving his M.S. degree in chemical engineering in 1949 and his M.S. degree in metallurgical engineering in 1952. He joined the University of Michigan faculty as an instructor in 1947. He was appointed assistant professor in 1952, associate professor in 1956, and professor in 1959. With his broad expertise in both metallurgy and chemical engineering, Professor Young's services were often

sought as an expert witness in cases of metal failure, explosions, and pipeline eruptions. A textbook that he co-authored on standards, metallurgy and design methods became a respected authority on the subject. The book *Process Equipment Design* was co-authored with Prof. Lloyd E. Brownell in 1959—the classic text on the subject and which is still being published.

The success of a Michigan corporation, Wolverine Tube, is directly related to Professor Young's research in process heat transfer, for which he was awarded the Donald Q. Kern Award by the American Institute of Chemical Engineers. He has also received the National Society of Professional Engineers Award, the AIChE Career Achievement Award, and other significant honors for his achievements.

Professor Young dedicated many years to the advancement of engineering as an honored and respected profession. He served as president of the Michigan Association of the Professions, president of the Michigan Society of Professional Engineers, president of the National Society of Professional Engineers, and for 12 years as a member of the Michigan Boards of Registration for Land Surveyors, Architects and Professional Engineers.

He is a fellow of the AIChE, the American Institute of Chemists, the American Society of Mechanical Engineers, the American Society of Heating, Refrigerating and Air-Conditioning Engineers, the Michigan Society of Professional Engineers, and the National Society of Professional Engineers. He is also a life member of the American Society for Engineering Education and the American Society for Metals.

The personal and professional successes of his students represent the most lasting and significant tribute to Professor Young. With wisdom and understanding, he provided guidance and encouragement to many young men and women. The impact he made on these young engineers and on the development of ethics and strength of character will continue to reflect his talents as a teacher, counselor, researcher, and role model. He currently lives in Ann Arbor with his wife Signe.

SOME FACULTY IN THEIR OFFICES IN THE 1980s



Bob Kalmbach
Dale E. Briggs, 3122 Dow, 1984.

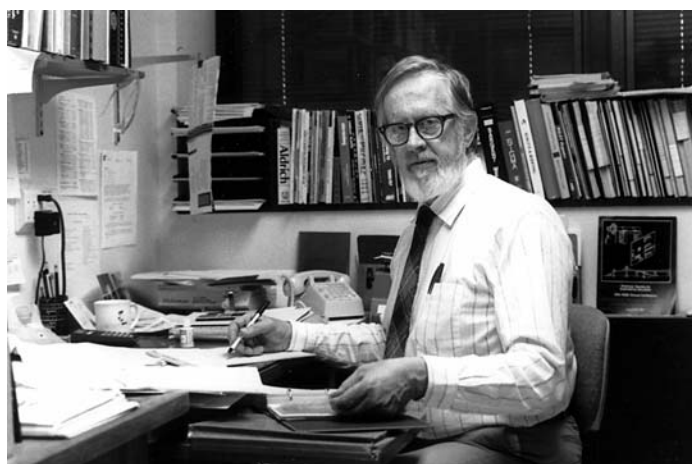

Rane L. Curl, 2114 H.H. Dow Building.



Philip T. Dattilo

Erdogan Gulari, April 1987.



Robert H. Kadlec, 3094 H.H. Dow Building, 1987.

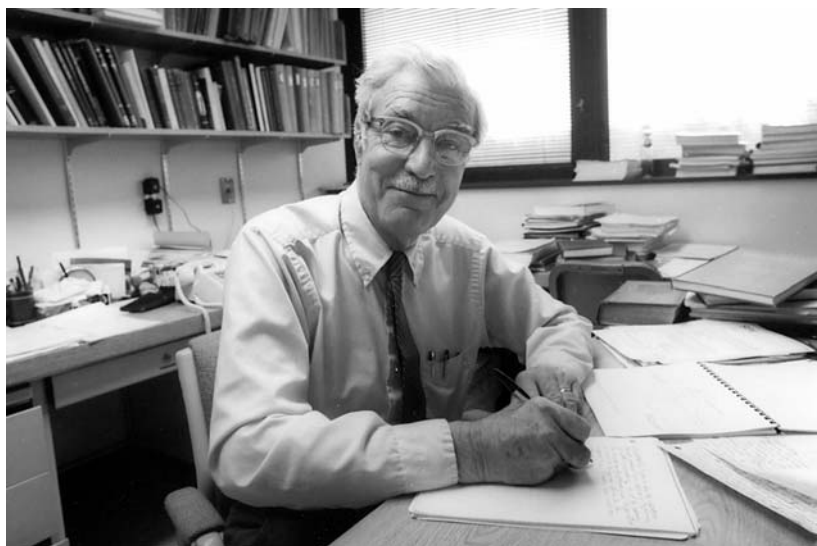

Donald L. Katz, 3022 H.H. Dow Building, 1984.



Bob Kalmbach

Lloyd L. Kempe, 3074 Dow Building, 1984.



Bob Kalmbach

Johannes W. Schwank, 3014 Dow Building, 1987.



Bob Kalmbach

Maurice J. Sinnott, 2094 H.H. Dow Building, 1983.

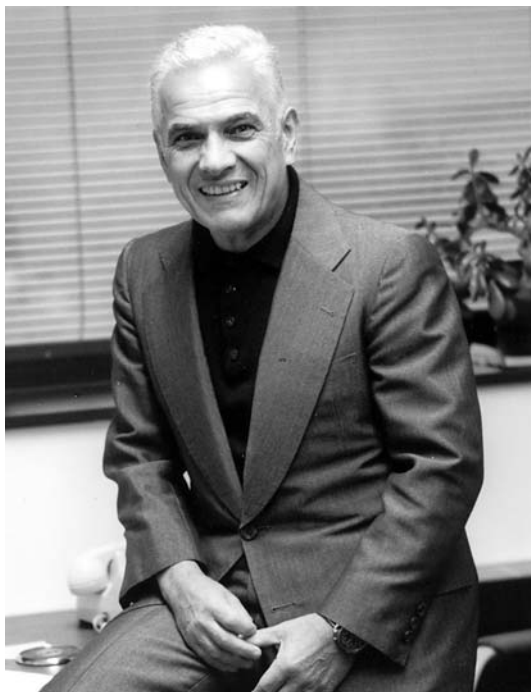

Bob Kalmbach

M. Rasin Tek, 3074 Dow Building, 1986.

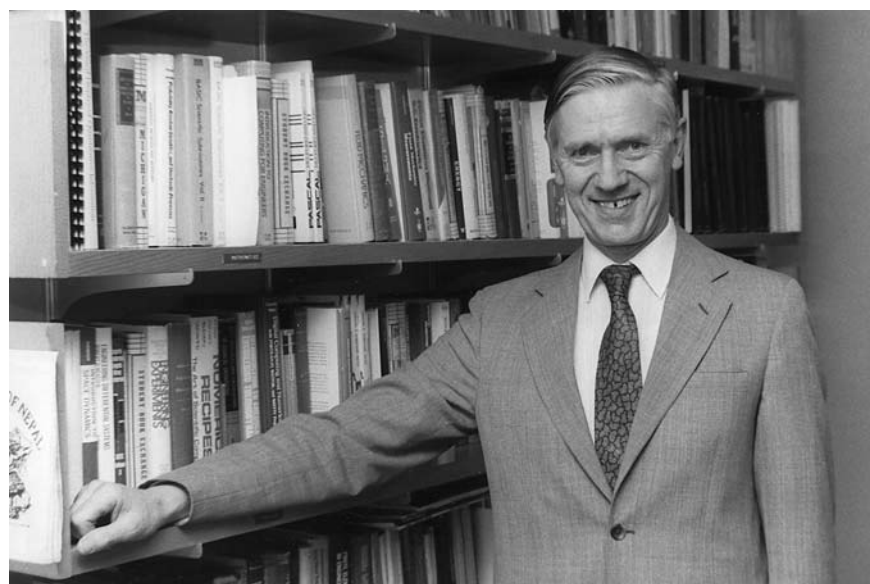

James O. Wilkes, 3146A Herbert H. Dow Building, 1987.

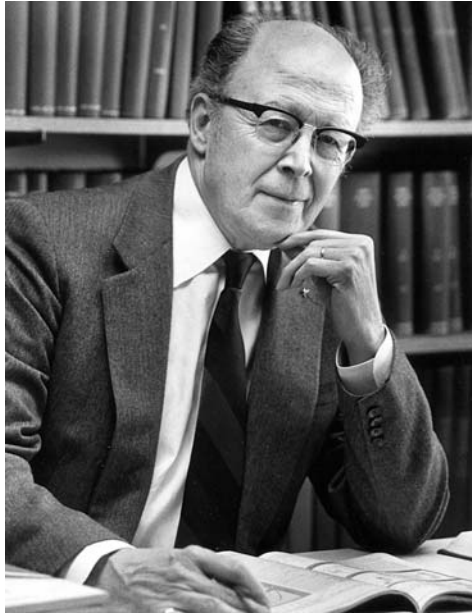

Philip T. Dattilo

*Edwin H. Young, 2118 Dow Building,
April 1987.*

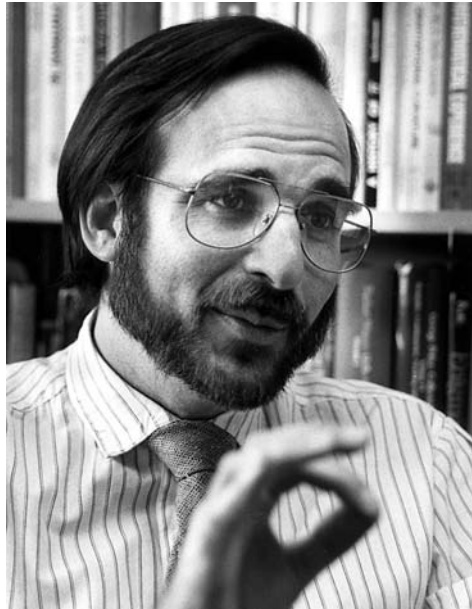

Philip T. Dattilo

Robert M. Ziff, 3018 Dow Building.



James Wilkes

This is an historic desk! It was originally used in the East Engineering Building by A.H. White, was then passed to G.G. Brown, followed by D.L. Katz, and subsequently Bob Kadlec (who brought it from East Engineering to North Campus and refinished it), and is now used by Susan Montgomery, shown here in her office, 3094 Herbert H. Dow Building.



Courtesy Brice Carnahan

Christine Garman, Brice Carnahan, Sandra Swisher, and Pablo LaValle, November 2002. West hallway, third floor, Herbert H. Dow Building.



Schenck and Schenck

Unrelated to this chapter, but patriotic nevertheless! The University of Michigan College of Engineering's solar car M-Pulse sped to a first-place finish in the American Solar Challenge on 25 July 2001. The 2,300-mile race along historic Route 66, which started on July 15th in Chicago, Illinois, and ended in Claremont, California, is the premier competition of solar-powered cars in the United States. M-Pulse crossed the finish line at 11:37 am PDT, making it the winner with a total time of 56 hours, 10 minutes and 46 seconds—one hour and 20 minutes faster than the second-place team and defending champions, the University of Missouri-Rolla. The taste of victory is especially sweet for the U-M team since a serious accident just one month before left M-Pulse debilitated and without much hope of even competing in the American Solar Challenge. A trial run along the race route near Oklahoma City on June 18, 2001, ended in disaster when M-Pulse's attempts to avoid a series of potholes launched the vehicle into a ditch. No one was injured, but the crash left many of the car's sophisticated components severely damaged. The following 17 days were consumed by a frenzied attempt to rebuild M-Pulse, which originally took a year and a half to construct. This effort included the rebuild or repair of the car's chassis, lower and upper surfaces, mechanical components, and solar array. Team Captain Nader Shwayhat said: "Through the amazing efforts of this team, including frantic 24-hour work schedules, emergency calls to sponsors, and endless rounds of last-minute fixes, we were able to restore M-Pulse to its original racing condition."

Chapter 20

THE CHEMICAL ENGINEERING ALUMNI SOCIETY MERIT AWARDS

OUR faculty, students, and alumni have deservedly received countless awards between them, and it would be virtually impossible to recognize all of them. We content ourselves, however, with one small selection—the annual Chemical Engineering Alumni Society Merit Awards, started in 1991, which typify the accomplishments of many of our students during their professional careers.

Carl A. Gerstacker—1991†



Carl A. Gerstacker began his career at Dow Chemical Company after completing his B.S.E. in chemical engineering in 1938. Very shortly after joining Dow, Mr. Gerstacker left for six years to serve in the United States Army, during which time he attained the rank of major and developed a leading expertise in ordnance manufacture. Mr. Gerstacker returned to Dow in 1946 as a production engineer. By 1948 he became a member of Dow's Board of Directors. He became treasurer of the company in 1949, vice-president in 1955, and chairman of the Finance Committee in 1959. In 1960, at the age of 44, he became the chairman of the board. Mr. Gerstacker retired as chairman of the board in 1976 but remained as the Board's Finance Committee chair, and was a director through 1981. Thirteen years into his term as chairman of the Board, *Business Week* dubbed him the senior statesman of the chemical industry.

Mr. Gerstacker's influence on industry is exceedingly broad. His enlightened use of debt financing brought the domestic chemical industry into the international arena. As chairman of the Export Expansion Council of the United States Department of Commerce from 1966 to 1973, and as a member of the United States Commission of UNESCO from 1967 to 1970, Mr. Gerstacker assumed the position

† It was the Alumni Society Medal (not the Merit Award) that Mr. Gerstacker received in 1991.

he retains today as an effective and respected leader in international commerce. Mr. Gerstacker has also served as a director of a number of corporations, including the Federal Reserve Board of Detroit, Carrier Corp., Chemical Financial Corp., Conrail Corp., Dow-Corning Corp., Dundee Cement, Hartford Insurance, K-Mart Corp., National City Corp., Sara Lee Corp., and Spence Engineering.

Mr. Gerstacker has received the United States President's E-Award for export services; the Society of the Chemical Industry Medal; the Order of the Rising Sun, 2nd Class, from the Emperor of Japan; the Ohio Governors Award; and the Silver Tower Award from the President of Korea. He also won an Outstanding Achievement Award from the University of Michigan in 1982. Mr. Gerstacker holds honorary doctoral degrees from Central Michigan University, Albion College, Northwood Institute, Waynesburg College, and Alma College.

Richard E. Balzhiser—1992



The University of Michigan recruited Richard E. Balzhiser in 1951 as a student athlete. By 1955, he had completed his B.S.E. in chemical engineering with distinction and was named to the Big Ten Academic and All-American Football teams. He completed his M.S.E. in nuclear engineering in 1956 and his Ph.D. in chemical engineering in 1961. During the following nine years, Dr. Balzhiser obtained tenure as a full professor, wrote a seminal textbook on thermodynamics, which is still used today, served as the first chairman for the newly organized Department of Chemical Engineering, worked as a White House Fellow under the United States Secretary of Defense for one year, served on the Ann Arbor City Council, and won the “Young Man of

Michigan” award.

From 1971 to 1973, Dr. Balzhiser served as assistant director in the White House Office of Science and Technology, where he directed energy, environment, and natural resources activities. Dr. Balzhiser joined the Electric Power Research Institute (EPRI) in 1973 as director of Fossil Fuel and Advance Systems Division, was named vice-president of Research and Development in 1983, and executive vice-president four years later. Dr. Balzhiser became EPRI's president and CEO in 1988.

Dr. Balzhiser served on the College of Engineering's National Advisory Committee from 1985 to 1992.

George Pilko—1993

George Pilko earned his B.S.E. in chemical engineering in 1971 and his M.B.A. in 1973, both from the University of Michigan. Today, Mr. Pilko is co-founder and president of Pilko & Associates, Inc., which specializes in assisting industrial and financial institutions in minimizing environmental liabilities and managing environmental risks. Pilko & Associates handles assignments in all 50 states and overseas for a wide variety of manufacturing, banking, and legal clients such as Amoco, British Petroleum, Exxon, Morgan Stanley, Chase Manhattan, and Chemical Bank. The company employs a staff of 80, located in its Houston, Los Angeles, and Cherry Hill (New Jersey) offices.

Mr. Pilko has published many articles and is quoted frequently in publications such as *The Wall Street Journal*, *The New York Times*, *Chief Executive*, *Mergers & Acquisitions*, *Director & Boards*, and *Chemical Week*. He is a regular guest speaker to executives on the topic of “How to Avoid Environmental Pitfalls During the 1990s.”

Mr. Pilko was born and raised in the New York area and has been a resident of Houston since 1975. He is active in several community organizations and the Presbyterian Church.

J. Louis York—1994

J. Louis York, after having earned his undergraduate degree in engineering at the University of New Mexico, began graduate studies in chemical and metallurgical engineering at the U–M in 1938. He received his M.S.E. in 1940. In 1941, the U–M called on him to serve as an instructor, filling in for faculty members involved in the war effort. After the war, he continued his graduate studies and teaching. While he pursued graduate studies, he was one of the co-authors of the textbook, *Unit Operations*, which has been widely used in chemical engineering around the world. He earned the Ph.D. in 1950 and held a succession of teaching positions for the next twenty years, helping develop courses and research work for the then-emerging

field of environmental engineering.

In 1970, Dr. York joined Stearns-Roger Engineering Corporation in Denver as chief environmental scientist. During his thirteen years in that position, he directed all environmental field work for the company. In 1983, he became an independent consultant and a vice-president of Senior Management assessment and consulting.

Dr. York is involved with the Colorado School of Mines and the University of Denver, serving on committees and boards for both institutions. In addition, he and his wife, Ruth, are active in the community as organizers for the Denver Art Museum, the Colorado Symphony, the Opera Colorado, and the Denver Center for Performing Arts.

Ieum Ieumwananonthachai—1995



Ieum Ieumwananonthachai received a B.S. from the Department of Chemical Technology at Chulalongkorn University in 1963 in Bangkok, Thailand, also serving there as a lecturer until 1970. He obtained the B.S.E. in 1965 and the M.S.E. in 1967 from the University of Michigan College of Engineering. Mr. Ieumwananonthachai is currently executive director of Nitro Chemical Industry Ltd., the first industrial nitrocellulose manufacturing company in Thailand. Concurrently, he is executive director of Reagent Chemical Industry Ltd., a company that is building Thailand's first industrial plant to produce ultrapure chemicals for chemical/medical laboratories and the electronic industry; director of Lab-Scan Asia Co., Ltd.; and director of Machinery Concepts Ltd. in Bangkok.

ery Concepts Ltd. in Bangkok.

He joined Esso Standard Thailand Ltd., an Exxon affiliate, in 1970, as a process engineer in its refinery, and was subsequently promoted to refinery planning section head, logistic planning division head, finance manager, supply and transportation manager, and was corporate planning manager when he left the company in 1982.

Mr. Ieumwananonthachai received the Chulalongkorn University College of Science's Outstanding Alumni Award in 1994 and the Outstanding Service Award from the Engineering Institute of Thailand from 1982 to 1984. He was recognized as Companion (Fourth Class) of the most Exalted Order of the White Elephant royal decoration in 1968.

He currently serves as co-adviser at the Chulalongkorn University Graduate School and as a guest lecturer of the university's Department of Chemical Technology in the Faculty of Science. He has been a member of the Executive Board of the Petroleum and Petrochemical College at Chulalongkorn University since 1993. Mr.

Ieumwananonthachai has been a member of the Chemical Engineering Academic Committee at the Engineering Institute of Thailand since 1978.

Peter B. Lederman—1996

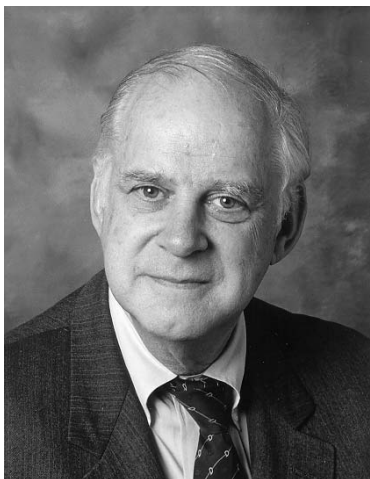

Peter B. Lederman earned all of his B.S.E., M.S.E., and Ph.D. degrees in chemical engineering from the U–M College of Engineering in 1953, 1957, and 1961. He is a significant contributor in all facets of environmental management and control and policy development, and has extensive experience in the petrochemical industry. Dr. Lederman is director of the Center for Environmental Engineering and Science, research professor of chemical engineering, and executive director for Patents and Licensing at the New Jersey Institute of Technology (NJIT). He spent 40 years in industry, academia, government and consulting, beginning his career with Shell Oil Company. After military service, he was an instructor in the U–M Department of Chemical and

Metallurgical Engineering from 1955–1960. Dr. Lederman was vice-president of the Roy F. Weston Company when he retired in 1992.

He is a fellow of the American Institute of Chemical Engineers, where he has chaired the Environmental Division, provided leadership to numerous committees, and serves as a director of its Foundation. He has authored more than 100 publications and served on the advisory boards of *Environmental Progress* and *Chemical Engineering Progress*. He is associate editor of the *Journal of the Air and Waste Management Association* and serves on the advisory board of the *Journal of Hazardous Materials*.

His many honors include AIChE's Cecil Award, the U.S. Environmental Protection Agency Silver Medal, and the American Academy of Environmental Engineer's (AAEE) Kappe Award. He is an AAEE diplomat and a registered professional engineer and planner.

Dr. Lederman has served as chair of the Engineering Alumni Society Board of Governors, as a member of the College National Advisory Committee, and as treasurer of the Class of 1953E. He is a director of the Alumni Association, representing the College of Engineering, and serves on the Manufacturing Engineering Program External Advisory Committee. He has served his community as a volunteer in the Boy Scouts of America, as a leader and president of his synagogue, and as a member of the Equal Opportunity Advisory Committee to the school board and solid waste management committee of his community.

Louis H.T. Dehmlow—1997

Louis H.T. Dehmlow received his bachelor's degree in chemical engineering in 1950 from the University of Michigan, where he was regimental commander of the combined Army and Air Force ROTC units. As a reserve officer in the Army Ordnance Corps, he was called for service during the Korean Action. He served as second lieutenant and first lieutenant at Picatinny Arsenal, Dover, New Jersey, with his last responsibility being Chief of Production Engineering, Munitions Production Officer. In 1952, Mr. Dehmlow became president of the Great Lakes Terminal & Transport Corporation (later renamed the GLS Corporation). He served as chairman and director of GLS until his sale of the business and his retirement in 1996.

Before his retirement, Mr. Dehmlow was active and held leadership positions in numerous trade associations and organizations connected with wholesale distribution. He served as president and director of both the National Association of Chemical Distributors and the National Association of Plastics Distributors. He was chairman and director of the National Association of Wholesaler Distributors, and was director of the Distribution Research and Education Foundation.

Mr. Dehmlow also regularly published and presented papers on wholesale distribution, especially within the chemical industry. His presentation venues have included the Kellogg Graduate School of Management at Northwestern University, Hillsdale College in Hillsdale, Michigan, and meetings of the Chemical Marketing Research Association and National Association of Wholesale Distributors. He has also presented papers and lectures on business management and leadership at the University of Wisconsin, Northwestern University, Texas A&M University, Iowa State University, and the University of New York.

Mr. Dehmlow was a member of the American Chemical Society, the American Institute of Chemical Engineers, the Society of the Plastics Industry, the Society of Plastics Engineers, and the National Council of Logistics Management. He has retained membership in the Intercollegiate Studies Institute and the Philadelphia Society.

Manuel del Valle—1998

Manuel del Valle is the retired president and chairman of the board of the Bacardi Corporation. He graduated from the University of Michigan in 1947 with a bachelor's degree in chemical engineering. That same year he received training at Davidson Chemical Company of Baltimore, Maryland, and the next year, Mr.

del Valle went to work for the Ochoa Fertilizer Corporation. He stayed with this company until 1960, becoming its executive vice-president.



In 1960, Mr. del Valle founded Manuel del Valle, Inc., a distributor of chemicals. He also founded Commercial Chemicals Corporation, which manufactures solvents. W.R. Grace & Co. hired Mr. del Valle in 1964 to manage a chemical complex that manufactured ammonia, sulfuric acid, and ammonium sulfate. He became the company's vice-president and general manager. From this position, Mr. del Valle worked as executive vice-president for the Rexach Construction Company. During his tenure, he oversaw the acquisition and development of several manufacturing operations in the fields of paper, plastics, and floor tiles. In 1979, Mr. del Valle was asked to become president of the Bacardi Corporation. He eventually became chairman

of the board, a position he held until 1992. During these years, Bacardi acquired a Coca-Cola bottling operation, developed and patented an anaerobic process for the treatment of wastes producing methane, developed an environmental laboratory, established an operation to recover carbon dioxide from fermentation, and created a new distribution division.

Since his retirement, Mr. del Valle remains involved in wide-ranging activities, which include presiding over the Alliance for a Drug-Free Puerto Rico, directing the Cantera Community Development Project, and participating in various corporations and foundations as director.

Lawrence B. Evans—1999

Influenced by his father, a chemistry professor at the University of Central Oklahoma, Larry attended the University of Oklahoma, where he received his bachelor's degree in chemical engineering in 1956. He then came to the Chemical and Metallurgical Engineering Department at Michigan, where he earned his Ph.D. degree in 1962. In the fall of that year, Larry joined the faculty of chemical engineering at MIT, where he served for three decades, making major research contributions in the areas of chemical process analysis, simulation, design, and control.

At MIT, Larry served as principal investigator for the ASPEN (Advanced System for Process Engineering) Project from 1976 to 1981, developing outstanding algorithms and software for simulation of very large and complex liquid/gas/solids chemical processing systems that could effectively solve tens to hundreds of thousands of simultaneous model equations.



James Wilkes

Given his strong entrepreneurial spirit (belying the cliché, Larry is both a teacher and a doer) Larry founded Aspen Technology, Inc. in Cambridge in 1981 with the goal of making his new company into a leading provider of software and services for the process industries. That he has succeeded beyond even his wildest dreams is now clear; his company dominates this important chemical engineering market sector worldwide. As chairman and CEO of Aspen Technology, Larry focuses on the strategic, long-term direction of the company, on financing and market issues, and on development of relationships with outside organizations. Now a professor emeritus at MIT, Larry was a founder and first president of CACHE, a non-profit corporation

for promoting computer aids for chemical engineering education. He has received many honors during his outstanding career, including two from the American Institute of Chemical Engineers: the Computers and Systems Technology Award in 1982 and the Chemical Engineering Practice Award in 1999. He was also the recipient of the New England Entrepreneur of the Year Award for High Technology in 1997.

Max E. Pettibone—2000



James Wilkes

A native of Buffalo, New York, Max Pettibone received his bachelor's degree in chemical engineering from the University of Michigan and a master's degree from Pennsylvania State University. His Michigan degree carried on a family tradition, as his father—Maurice Pettibone (A.B. '33, J.D. '38)—was also a U-M graduate. Following military service as a U.S. Army base commander in northern Germany, Max Pettibone founded and managed a land-development firm in the suburban Washington D.C. area. Under his leadership, the company developed over 20,000 lots in both the residential and commercial markets inside the Washington Beltway during the heavy growth years of the 1970s through the 1990s. Taking advantage of market conditions,

he eventually diversified into all phases of land development, construction, and real-estate investments. Now semi-retired, Max continues to pursue real-estate ventures.

Mr. Pettibone is an avid sportsman. He fishes the Outer Banks and plays hockey on a local team. He is also a member of the University of Michigan Major Gifts Committee in Washington, D.C., and is an enthusiastic fan of Michigan's sports teams. As the father of one son and three daughters, he has served on several Fairfax County (Virginia) school-board committees. He is a past president of his local PTA, and continues to be active in education affairs.

Tenho Sihvonen Connable—2001



Sandra Swisher

Throughout her entire life, Tenho Connable has cultivated an intense curiosity for science and technology, together with an active interest in the University of Michigan and its College of Engineering. Along with her husband, the late Regent Emeritus Alfred B. Connable, she has been one of the university's most loyal and active alumnæ. Receiving her bachelor's degree in chemical engineering from Michigan in 1942, Connable was among the first female engineers to graduate from the College of Engineering. In 1941, she became a member of Tau Beta Pi. Upon graduation, she worked briefly as an administrative assistant for the vice-president of operations at the Shell Chemical Company in San Francisco.

After raising four children, Connable continued her interest in engineering and completed a master's degree in mathematics with a concentration in computer science at Western Michigan University in 1973. She went on to teach at Western, first as an instructor and later as an adjunct assistant professor of computer science, before retiring from teaching in 1983. To this day, she continues to be fascinated with science and technology, and has a special interest in both chaos and string theory.

Stuart W. Churchill—2002

At the time of completion of this book, the citation for Stuart Churchill was not yet available. However, a detailed biographical sketch of him, with photographs, appears on page 146.

AN INTERVIEW WITH BRYMER WILLIAMS

Introduction

BRYMER Williams has been associated with the department longer than anybody else in its history—from 1935 until the present. As a major contribution to this book, Brymer kindly consented to be interviewed by Enid H. Galler, of Voice Treasures, Ann Arbor, on several occasions between the 3rd and 24th of February 2000. There resulted six audio tapes, each approximately an hour long, and each of which has been transcribed. In this chapter, we have adapted and condensed most of the material on the first four tapes.† The commentary falls into three major and broad categories:

1. Brymer's career, which inevitably touches on other people and events.
2. People and events before 1960.
3. People and events after 1960.

1—BRYMER'S CAREER

My Early Life

I was born in 1913 in Denver, Colorado and had one sister, six years younger. In my early days, I could ride from one end of Denver to the other on my bicycle in not much more than an hour. The Depression affected our family badly—my father was out of work for about a year, during my last year in high school. I suppose it was grim but children were fairly well shielded by their parents from the terrible realities, and the family kept together. I attended Denver's East High School, and the building is still there today. It was a superb academic experience; in 1930 calculus was offered there regularly, which didn't happen in most other high schools until after Sputnik.

My main interests were in chemistry and English literature. We had a well-equipped chemistry laboratory, but looking back I can say that it would have made today's teachers quiver at the things we did. We were fooling with hazardous

† For the last two tapes, Brymer was joined by Maury Sinnott, but most of the resulting material has not been included because it deals primarily with events outside the Chemical Engineering Department.

materials without realizing all the dangers. A special high-school teacher for me was Marie Beynon, who taught English and American Literature, and that was my first real exposure to good literature. She was a sympathetic, inspiring teacher, well-read herself.

I attended the University of Denver because it was cheaper and I couldn't afford to live away from home. The university was then not as good as it is today. It had a very good chemistry faculty, but they just had no experience in teaching the so-called engineering, which was very weak. However, there was a program called chemical engineering, which sounded good and there was a very small class—ten of us in that program altogether. It was more chemistry really than chemical engineering. The reason that most of us went to college was to earn a living, not for general education or family improvement. Most of us were the first of the family to attend college.

I didn't complete my degree at Denver, and in fall 1934 accepted instead an invitation from my uncle, David McK. Williams, to live with him in New York City. He was a musician, organist, and choirmaster, at St. Bartholomew's Church. Although I took mechanical engineering classes at Columbia University, I found Manhattan was an exciting but distracting adventure. There was much social activity around our church in New York, and the diversions were too many, including opportunities to attend the opera and concerts of all kinds, and I just wasn't studying very hard. One of the men I met worked for the old Union Carbide Company and part of his responsibilities was recruiting students, and he visited three schools—MIT, Columbia, and Michigan. He had very good opinions of Michigan, so after a year of thinking about it I just left and came to Michigan in 1935. I'm one of the multitude that arrived at the old Michigan Central Station, checked the suitcase, and walked up to the campus.

I arrived at the U-M 56 credit semester hours short of the chemical engineering bachelor's degree requirements and they were tough to complete. I managed it in two semesters and the summer session. That was not far from half of the total requirements, and it was a hard-working year. I was very lucky to find a room with three other students. Two of them were aeronautical engineers, and one was a chemical engineer. The atmosphere was just right. The three were very industrious and set a good example. There was nothing for me to do but fit in with the crowd and work just as hard as they did. I had financial help at first from my uncle, for which I am forever grateful, although it was not expensive at all. Tuition was very low, about \$50-\$75 a term for non-residents. As far as expenses, the total cost, tuition, clothing, everything, was less than perhaps the board and room in New York City.

I had already heard of Professors Badger and McCabe—we used their textbook in Denver as much as we could. Oddly enough, the first faculty person I ever heard of from the U-M was Professor Gailey who wrote that book that I read as a child,

Gailey's *Classic Myths*, which I loved. That was the better part of two centuries ago that he was here—in the 1800s! He was in the Classics Department, and wrote this very popular book for older children.

Drake Parker was one of the first undergraduate students I knew in our department. He had a car, a convertible, which, as a student, he wasn't allowed to drive. He was one of the better students and was one of the few who got a summer job in industry. Drake's father, his uncles, and his aunt had quite a Michigan history. His father was an electrical engineer on the faculty at one time, I believe. All the family all had interesting names. Drake's father was Ralzemond D. Parker, well-known to electrical engineers. His aunt was Marion Sarah Parker, who was possibly the first woman to have graduated in engineering, in the 1800s. She lived, unfortunately, a short life, but a very active one. It was unusual for a woman to become a construction engineer and she was the one who supervised the construction of the old Flat Iron Building in New York. She was gone long before I arrived.

Drake was involved in the Badger Trophy, which still exists. It is a loving cup made out of pipe fittings. It was awarded annually at the graduate student/faculty picnic that traditionally started the year. The trophy was awarded for the worst piece of laboratory equipment constructed that year. It was first awarded to Warren McCabe and his students, who had put together a rather large piece of apparatus. I was one of the ones who worked on it, and it was fun. It was really horrible because all the parts were scrounged from the scrap heap—there was essentially no money available for anything. Expenditures of even \$2.00 or \$3.00 were very hard to come by in the mid-1930s. It would not be as understandable to today's students. There were three students and Walter Badger whose names are on the trophy and two of those students are still living. One of them is Drake Parker, who was the best writer among the students, very clever.

In 1919, Dorothy Hall was the first woman to earn a bachelor's degree in chemical engineering at the U-M. Her son, Jere Hall Brophy, graduated with a combined degree in chemical and metallurgical engineering in the 1950s. On graduation day, he brought his parents out to our home and that's where I met his mother. Her Ph.D. was in chemistry, which she earned in two years. She had an industrial career with General Electric.

The very first class I attended at the U-M was a senior class in chemical engineering, taught by Warren McCabe. He began the class by handing out an exam. Later that day I was in a senior laboratory class, and Professor Brier started the class by saying, "If it weren't for you fellows I would be in Detroit watching the World Series today. Now get out in the lab and get to work." And that was an indication that this was a place for men to work, not for boys to play. As for other faculty, that was the year when I first met G.G. Brown, who had a recitation section where he worked us very hard. We were all sent to the board

to work problems so he could watch us at work. That was a sophomore course. So, in one semester I was taking the beginning course of chemical engineering and the graduate courses. I also came to know Lee Case, who was a dry-as-toast but imaginative professor with a nice sense of humor who taught a very difficult physical chemistry course.

I found that the gigantic and supposedly impersonal U–M, which had perhaps 12,000 students at the time, gave me much more competent personal attention than did the much smaller University of Denver, which had somewhat over 1,000 students. This is not a criticism of Denver. It is just showing the spirit and interest of the faculty at the University of Michigan. The U–M classes were much larger than I had been used to, but they looked at all of us as individuals.

Professor Brier was always out in the laboratory. He had a very competent teaching fellow, Charlie Brooks, who was completing his Ph.D., as teaching fellows did; both of them were demanding, but sympathetic and helpful. Charlie Brooks was dating and eventually married the daughter of Professor Rouse of the Mathematics Department, which is maybe another indication of the smallness of the U–M. Also, Professor Edwin M. Baker, who taught the second term of our senior course, was another demanding, but very helpful teacher.

I took Professor Badger's unit operations course when I was a graduate student. Most of our classes were in the East Engineering Building, which I thought was the most elegant building I'd ever been in. It was barely ten years old in 1935 and to me it was like a palace, with well-equipped laboratories and good classrooms.

There were two undergraduate laboratories, and each had a continuous 48-hour session towards the end of the semester. In the beginning course, *Engineering Calculations*, the laboratory at the end was a 48-hour test run in the U–M power plant, each student serving two eight-hour shifts. In that one, the students took all the measurements of the boiler and the steam and power production. They analyzed all of the coal going into the plant and samples of the ash and stack gas leaving the plant. Thus, there was a complete energy and material balance for a 48-hour period. The senior course involved an evaporator laboratory, which was built by Professor Badger, consisting of essentially semi-commercial equipment, the sort that is no longer possible to use these days. That laboratory ended with a demanding continuous 48-hour run, evaporating a brine solution to produce crystalline salt. The focus was on learning to run equipment so that we could keep it going for the 48 hours. A comprehensive report was also required.

Professor Badger's laboratory was large and occupied essentially half of one wing of the East Engineering Building. It began in the basement and had grating floors up to the third floor and so the tall equipment could run through three floors. Badger was a consultant for the old Swenson Evaporator Company and he scrounged much of the equipment from them, and in turn he did quite a bit

of experimental work for Swenson. Badger was quite active as a consultant in the evaporation of salt and sugar solutions to produce pure materials. He left for industry shortly after I came to Michigan.



James Wilkes

East Engineering (now East Hall) from the northwest. July 2000.

The metallurgical foundry was another important (and controversial) laboratory in East Engineering. I was impressed with it as a student although I never worked in it—just by the fact that there could be a thing as dramatic and large as a foundry in a university building! It did a lot of good for the Michigan foundry industry, which was related to the automotive industries. As the industry developed, it was questionable whether a university foundry could really perform the function it should both in the university and industry, and there were obviously differences of opinion about it. Let's say it was the only foundry in a university in the United States!

I became fascinated with the unit operation of distillation through Warren McCabe and G.G. Brown, both of whom had good consulting arrangements with industry. At the University of Denver the faculty were more or less isolated. If they needed something outside engineering they had to find a local engineer, but at Michigan the faculty were actually practicing their profession and G.G. Brown was very active in the petroleum-refining industry, which was fascinating to me partly because of Brown and just because of the nature of the industry. Modern chemical engineering developed principally through the petroleum-refining industry.

I decided to go on for a Ph.D. practically at the end of the year. It was the easiest thing to do because jobs were very scarce and I was also offered a job as one

of the laboratory assistants. It was offered by G.G. Brown, Donald McCready, who taught the course the lab was associated with, and Richard E. (Dick) Townsend, who ran the laboratory. A.H. White of course had to approve.

About a quarter to a third of our undergraduates decided to continue for a Ph.D., partly because of the dearth of jobs and partly because the school had a well-established and good graduate program—it was one of the very best of the few in the country. Roughly, we had 75 or 80 graduate students altogether in 1936. Other notable programs were at MIT, Columbia, and Wisconsin. I had strong encouragement from all the faculty, but particularly from G.G. Brown and Dick Townsend.

Life as a Graduate Student

When I was an undergraduate, thank heaven, I fell in with three hard-working students who were all from New York and New Jersey. We have been friends since our freshman year at Michigan. We lived in what was a defunct fraternity that became a rooming house at 915 Oakland. We each paid \$3.50 a week. Four of us had desks in one room and we slept in an unheated dormitory on the top floor. We got up early in the morning. All of us had three meals a day, breakfast, lunch and dinner—20 meals a week at Ma Wilson's Boarding House, for which we paid another \$3.50 a week for those scanty meals. Her boarding house, now gone, was on the corner of South and East Universities, where the bank now stands.

After classes during the day we had dinner at Ma Wilson's and then returned home and studied. About 10:30 PM we would break and walk a block or so down to Fletcher's Drug Store, where we had a luxurious milkshake that cost us 12 cents, after which we went back and spent the final hours studying. There was one break in that routine—for athletic events, mainly home football or basketball games on Saturdays. On Sunday evening we always went to the old Michigan Theater for the early movie and then we came back and finished the night studying. The rooming house had a nice side lawn so in good weather we'd have games of touch football for half an hour before dinner for exercise, but mostly it was study.

I had different roommates in the graduate years, which were also a little bit different because for those of us who had jobs in the department, desks were provided, where we could study rather than in the rooming house. East Engineering was always very busy and was an especially wide-awake, lively, and friendly building at night.

I think that graduate students in my day worked harder than those today, but whether I'm right, I don't know. There was a little more acquaintance among graduate students in those days because we all studied in the building. The main difference is that many more of the graduate students are married now, some with children, and that of course puts another demand on their time. The graduate students certainly made many lasting friendships with one another.

In talking about how I came to meet my future wife Ruth, you have to understand how hot the summer of 1936 was. It was really unbearable. It was record-setting. Summer school classes were either dismissed or met outside on the lawns. I think Ruth's title was assistant social director for Jordan Hall for a few years and her job, one summer, was as the chaperone representing the dean of women at the Pi Phi House. That summer, my roommate and I lived in a fraternity house right behind the Pi Phi House and everything was open. We all got out on the rooftops or the top of the garage or anything like that to study and there was a noisy bunch of girls in the Pi Phi House. Well, one of them was Ruth and, as things happen in colleges, we just got acquainted that summer of 1936, and that was it.



Ruth & Brymer Williams, receiving the department's Special Outstanding Service Award, Donald L. Katz Lectureship dinner, Michigan League, April 1997.

We were eventually married in 1940. Until then, Ruth continued her job during the terms as assistant social director. Incidentally, that's another difference between university and student life—there were two chaperones—the social director or house mother, Miss Isabel Dudley, and the assistant social director. Ruth was the assistant for which she was paid \$40.00 a month plus room and board at Jordan Hall. There were, I think, apart from the kitchen and janitorial help, only three other employees in Jordan Hall with 250 women in it, including a receptionist and a telephone operator. There are now resident advisors, counselors, and directors and I think there is no real resident director as Miss Dudley was then. Miss Dudley and Ruth each had their own separate rooms.

People did not marry young in those days, mainly because of lack of appro-

appropriate income relative to now. However, we spent a couple of happy years dating. When we were married, we lived at 1402 Washington Heights (the old Observatory Lodge) for \$50.00 a month, which was more than we could really afford. We had to be interviewed by Mrs. Fennel, who was the manager of the place before we could be permitted to rent an apartment, although she didn't ask to see the marriage license.

Apart from Ann Arbor being much smaller in 1940, there was very little across the north side of the river. Stadium Boulevard, if it existed then, was a dirt track. Housing essentially ended at Washtenaw at that manorial-looking apartment house, on the right just beyond the Brockman turning.



At last, we have found an appropriate place to include two parking permits! These hang from the inside rear-view car mirror. Both tags are of the “blue” variety, and allow faculty and staff to park in most locations, but not the elite “gold” places. The cost—for 12 months—was \$394.25 for the year 2000 and \$408.12 for 2001.

Parking was no problem. Even into the 1950s there was parking for 24 cars on the north side of East Engineering and that was enough. There was always a parking space, but now that 500-car structure behind East Engineering is not enough. That aspect of Ann Arbor—traffic and parking—is far different today.

There wasn't much of a traffic problem either because students were not al-

lowed to have cars, and it was surprising how that ban was obeyed. It started with President Little, didn't it, in 1928? Students came in cars and they obeyed the rules. They put them aside, garaged them, registered them, and the penalty for violating the auto ban was severe. The penalty for the first offense was customarily five hours added to graduation and if it happened in the last term, your senior year, it was five hours added to whatever you had, so graduation would have been delayed. I went east with my roommates during the Christmas holidays. The routine was simple—they went to the office of the dean of men and got approval to drive their car at noon or whatever on the last day of classes and they did not drive them until then. Thus, the ban was obeyed and enforced.

There were very few hotels—the Earle, the Allenel, and the Embassy, the last of which is still there on the corner of Huron and Fourth. The Allenel was really the only hotel in town apart from the Michigan Union, which served some of the purposes of a hotel, but the Allenel was a nice old institution. It was under \$3.00 a night even until the 1950s, when it still existed.

There were also very few restaurants. Students ate in rooming houses or boarding houses—there were some notable ones, such as Freeman's and the Wolverine Den, which were large boarding houses. Ma Wilson's was small, with only about 30 people in it. Lots of people made their living renting out rooms.

The few dormitories included the old Fletcher Hall, a very small place down near the athletic campus, and Victor Vaughan House, which was for the medical end. The first large residence hall for men was East Quad and that was built in the late 1930s, but there were residence halls for women and the so called league houses. Women and men had to live in approved housing, and those for women had to have approved house mothers, who kept hours.

The Second World War

For my doctoral research, I worked under Prof. G.G. Brown on the properties of mixtures of hydrocarbons. I had finished the experimental work and was beginning on the text when Ruth and I just plain ran out of money and we had to leave. Fortunately, I had gone off on an interviewing trip and gotten a job offer in the spring of 1941 from the M.W. Kellogg Company, located at 225 Broadway in New York City, right between St. Paul's Chapel and the Woolworth Building facing City Hall Park. We had laboratories and shops in Jersey City, but the engineering was all in the office in that transportation building in New York City. Ruth enjoyed living in the center of Manhattan—First Avenue and 55th Street, which was a completely Irish section that has since changed. At that time, Kellogg had built approximately half or possibly more of the world's petroleum-refining capacity, and it was probably the third of a handful of four or five important companies who divided the business of building chemical plants and petroleum refineries between them. And we thought Kellogg was one of the earliest and most important ones.

With World War II approaching, this was the time when there were major developments in catalytic cracking, which was replacing old-fashioned thermal cracking in the petroleum industry. So much of the work was on the development of that, which came along just in time to preserve us during the war. The company had to diversify to meet the war demand. Besides petroleum refining, we built a magnesium plant, which was operated by the Dow Chemical Company, and a few other ordnance plants. Incidentally, the Kellogg Company is the one that formed the Manhattan Project. All of the engineering for the nuclear program in the Manhattan Project was done in the Woolworth Building under the name of the Kellogg Corporation formed by the Kellogg Company. That's another story. So, we very quickly got into wartime business, which involved expanding petroleum refining for aviation gasoline production and a few other extraneous plants, oxygen production for military purposes, metallurgical plants, and more.

The work was extremely important for the war effort, and the whole petroleum industry pitched in. The anti-trust laws were suspended so that petroleum companies could cooperate and share information on the production of aviation gasoline and synthetic rubber, both of which were vital. Some of the technicians in our company were drafted, and after basic training they were sent back to the company, especially to the atomic-bomb work.

Before Pearl Harbor, the company was already involved in engineering and designing plants for the government and for the various ordnance depots. I can't tell you just when, but we started working Saturdays and three nights a week. We moved to 56-hour weeks and about that time the company formed a subsidiary called the Kellogg Corporation. It began as something within the company called "Project X." On one of those nights when we went out to dinner, the executive vice-president of the company, Percy P.C. Keith—known as "Dobie" throughout the industry—casually mentioned "I had four Nobel Prize winners in my office today talking about Project X," leaving us wondering just what Project X was—because that was of the utmost secrecy at the time.

I still feel a lot of loyalty to the Kellogg Company. I think we had the best engineers in the world. Most of them were from MIT, but with a good sprinkling of Michigan engineers, many of whom were classmates of G.G. Brown and remembered him well. I very much enjoyed working for M.W. Kellogg, and we left with regrets.

I saw G.G. Brown and Don Katz intermittently throughout the war when they came to New York, either for technical society meetings or their consulting business. I also met a few of my fellow Michigan students who were either working for other companies in the petroleum business or for the Kellogg Company itself. I learned that many of the senior faculty had been called to active duty. Elmore Pettyjohn was in active duty in the navy, and Al Foust and Jack Brier were in active duty in the Ordnance Department at the Pine Bluff Arsenal in Pine Bluff,

Arkansas. Ed Baker was very busy consulting in what turned out later to be one of the important aspects of the Manhattan Project. A.H. White was busy keeping the department together. Teaching in those days meant the accelerated program for the Armed Forces for three full terms a year, with no break at all.

With the temporary departure of the senior faculty, Brown impressed four very good graduate students into his service teaching, and they subsequently remained on the faculty. They were known as “Brown’s Brats” and they were J. Louis York, Julius Banchemo, Cedomir Sliepcevich, and Lloyd Brownell. There was probably some war work research being done in the department. However, they were so occupied with instruction in that accelerated schedule that the relative amount of research probably went down.



Cedomir (“Cheddy”) M. Sliepcevich.

The suggestion that I might be welcomed back to Michigan was after the war was over, when I just stopped in Ann Arbor on the way back from a business trip for Kellogg from Chicago and came back to visit the East Engineering Building. At the rear entrance I accidentally bumped into G.G. Brown, and his first words were, “If you ever finish that damn thesis, we’ll have you back here.” Well, that was the first indication that there was a possibility. Ruth and I were immediately interested, because we had both liked Ann Arbor. We enjoyed New York, too, but we liked the life of the university. By that time we already had two children, and New York was not an easy place to bring up children.

Other than the usual teaching activities of the laboratory assistant for two years as a graduate student at the U–M, my first real semester-long teaching experience was while I was at M.W. Kellogg, replacing a professor who was away at New York University. I enjoyed the experience very much, although teaching a course two nights a week does not allow you to see all facets of university life.

Return to Ann Arbor

It was not too difficult a decision to leave Kellogg and take an academic job, although many of the reasons for making the move appeared after the decision was made, and these involved family life and returning to a small town in the Midwest. When I returned, G.G. Brown was the chairman of the department, and my dissertation was completed and bound, although I had not had the oral exam and I had one formal requirement remaining—in the French language. So, in that first year back at the university I was appointed as an instructor because in professorial rank, I could not have worked for the degree.

G.G. Brown was very helpful, and I had a gentle introduction working with Lou York and being introduced into the new curriculum of the department. I was also given a chance to participate in the writing of the textbook that Brown stimulated and inspired eleven of the departmental faculty to be involved in writing, and that textbook was really the heart of our undergraduate program. Brown assembled a team and they worked together both on the textbook and incorporating it into their classes. It was good for the program and good for the industry to produce that textbook. Getting used to Ann Arbor, and becoming re-acquainted and involved in the program was a very happy year; busy, but happy.

My appointment was probably made by Brown, after informing and consulting with all of the faculty. I'm sure he would not act without faculty support, but he would not call a meeting and ask for a vote. That wasn't his style. The method for appointments was quite different then. That was in the days before positions were advertised and candidates invited, at university expense, to come and give a talk and be judged by students and faculty. As a matter of fact there were no university expenses then either for interview visits or for moving.

I had returned to Ann Arbor in 1947, after a seven-year absence. Those were the years with a very large enrollment of students on the G.I. Bill. The G.I.s were mostly graduate students; they were an interesting, mature group who knew what they wanted. They did work hard and several of them were married. There was perhaps a little less campus life than before the war, primarily because of the living arrangements. So many of them lived in the Willow Run area, so there was less of a difference between the young faculty and the older graduate students, and there were many friendships that still endure between the faculty and those same graduate students. The situation was almost that of colleagues rather than teachers and pupils.

In those days, most of the students were white males, not many women, and not many minorities. However, foreign students were beginning to make an appearance, including some very good ones, particularly from India. There were several Canadian students too, who came south for graduate study.

There were very few women then, but I do recall Mary Worsham who had been here, I think during the war. She was a graduate of Wayne State University

who came here for graduate study and I think she was probably the first woman to serve as a teaching assistant. She is still around somewhere. She was back for her 50th reunion a few years ago. There had also been a number of new faculty appointed because the number of students had grown so much that the faculty had to be increased, too.

Professor Pettyjohn was one of the faculty members in the 1930s. He had been a graduate student in the 1920s. He went off to industry, and came back somewhere in the mid-1930s, and stayed on the faculty until he was taken back to active duty in the navy. He served in the Bureau of Ships on very active duty throughout the war. After the war he did not return to Michigan but he did go back to teaching and he was on the faculty of Fenn College in Cleveland, which was an engineering school that was absorbed and is now a part of Cleveland State University. He retired from that and went south. Just before the outbreak of World War II, he served on the review board of the Selective Service Agency for the state of Michigan. I did see Pettyjohn quite often throughout the war in uniform. He was a commander working for the Bureau of Ships, and he came into the Kellogg Office rather frequently to see other people and once he had with him Clifton Goddin, who was one of my classmates in chemical engineering as an undergraduate. Clif returned some 20 years later, in 1960, to continue graduate studies and he did earn the doctorate in the department and he has been a good friend of the department ever since. Another person who was here on the faculty for a short time during the 1930s was J. Henry Rushton. He stayed one year. He was a good teacher, but he found a better opportunity elsewhere. I think he finally closed his career at Purdue University. I used to see him fairly frequently during the war years because he was associated with the Oxygen Research Project. He later became one of the presidents of the American Institute of Chemical Engineers.

Courses Taught by Brymer Williams

In my early years, it was Brown's idea, and to some extent Don Katz's, that everybody should be able to teach any required course, and to some extent we did. After the influence of Brown and Katz, we tended to settle down into courses that were more our less our prime interest. For me, that mostly amounted to process design, which was a senior course. I did not like lectures because I don't think they are the best way to transmit information. I much prefer to have a class which discusses the students' homework and assignments. There's a difference—the earlier courses consisted mostly of learning by solving short problems. The senior design courses are more likely to include one single large problem of a design project of a chemical process of some kind or another for which there is no single solution. And there's plenty to discuss in that because the senior courses are based on the knowledge and abilities of learning in the first three years, including math, physics, and chemistry. Design inevitably requires every bit of engineering, scientific, and

mathematical ability that a student possesses. More lately, particularly under the impetus of Scott Fogler, the lower courses have incorporated several of the so-called “open-ended” problems, which do not have any specific solutions, but which leave room for student judgment.

I prefer the open-ended type of problem, because it leads to interesting inventiveness and a lucid imagination by the students, but the ability to solve those does depend on the thorough abilities or knowledge of basic science and the so-called closed problems.

I recall being asked by someone I hadn't seen for some time, what was I doing? I said: “I have gone back to teaching,” and my friend replied: “No, you lead classes. The students will decide whether you're teaching or not.” I would not claim to be a good teacher. I thought that G.G. Brown was a superb teacher and I was a little bit shocked to learn that many students thought he was a horrible teacher. Brown's style was not to answer a question directly, but to ask students questions in reply, and he was very good at it. Apparently I copied his method, because I learned later that students told me they never got an answer! Our children always told me they got a 30-minute answer when they asked a question. Brown had the same superb skill of asking questions that took the student back to some point at which the student was confident. Then, having found that, Brown wouldn't lead him away from there until a student in effect answered his own question. I admired that style, but Brown was superb, brilliant.

There is one bit of teaching to which I look back with immense satisfaction. Many years ago, the college changed its requirements in the area of humanities, and at the time, it went roughly in two directions. The college emphasized writing and grammar in the freshman year, so they could concentrate in the senior year more on writing or speaking, oral and written presentations, when the students had something more to write about. So one of the requirements was a three-hour course in so-called senior rhetoric, and there was one in technical-report writing, and John C. Mathes and Dwight Stevenson of the Engineering Humanities Department and I got together and agreed there would be a section at the time in the senior process-design course. The students would simultaneously elect the senior rhetoric course in technical and report writing in a section that was limited only to chemical engineers taking the design course. So, this meant that the students were in effect taking a six-hour course divided between presentation and the work itself, and I think that worked marvelously well. Mathes and Stevenson were enthusiastic about it, although they had some arguments against it. Principally, they looked at their courses as ones in which students should learn to present things to other engineers regardless of the discipline. They went along with us, and I think the result was an outstanding combination of courses. We tested this. We gave some of our student reports—both from the old system and the new system—to outsiders to judge, and there is no doubt that the combination of the two disciplines produced far better

reports, and I think the students liked it, too. Unfortunately, that arrangement has now disappeared with the general change in the college curriculum, and we no longer have that cooperation or coordination.

I always tried to be accessible to students. Certainly I posted office hours, which were times when we were guaranteed to be there, but the students showed no hesitation in coming in whenever they wanted to. I felt I was always behind in preparing for classes. Some of my most pleasant experiences were in laboratory courses, particularly when we gave our senior laboratory course in a different way. The usual approach was the four-hour or half-day laboratory, which was never satisfactory because there's too much start-up and shut-down time as well as scheduling difficulties. So, we persuaded the administration to let us give that same course *all day* and *every day* except Sundays in the two weeks immediately following the end of winter-term final examinations. I found that was one of the most satisfying experiences ever, and I think the students enjoyed it too.

The student came in late in the morning and then they were free at night, usually around 7:00 PM and it was one of the few times that I can see when a group of students became a class immediately. Our laboratory equipment limited the class to about 16 students, so the students became better acquainted with each other. The teaching assistants and I enjoyed it more because it simulated a real job experience. The laboratory in that time contained large-scale equipment that we can either no longer afford or is environmentally infeasible, and I thought it worked very well. It did one other thing which I'm sure the administration didn't like. It meant that the students could elect three more hours than they usually would during the winter term (without paying more tuition!), and I think it helped those who wanted to complete their studies early in the summer session. It was a far more efficient way than the short four-hour laboratory.

Promotion to Professor and Acting Chairman

I became a full professor in 1956, the decision being made by the chairman after consultation and full discussion by the full professors of the department. I think the criteria for promotion were mostly the evaluation of the promise of the individual for the ability and the desire to continue a full program of research and teaching and commitment to the university. Within limits, research and teaching were given equal weight, but it was certainly essential that there be a desire to continue research.

When Don Katz went on a sabbatical leave during his chairmanship, I was asked to be the acting chairman and that was the year 1956/1957. It was a very happy year. There were no very difficult problems of any huge consequence. We had a good faculty. The office staff was very pleasant to work with. Our departmental office was known as a good place to work around the university. Don Katz was very helpful. He was not around a lot and he did not interfere, but

he let me know that I should act when necessary.

That was the very sad year when Dean G.G. Brown's lung cancer was diagnosed. We were all aware of the probable end, and Brown did have some difficulties because there is so much he wanted to accomplish in such a short time. He had surgery, and he said afterwards that had he known what he would be in for, he would not have agreed to the surgery, that he would have had a few more months of well-being rather than the months of recovering from surgery.

Brown at that time was more than just a dean of engineering. I cannot give you the dates, but that was when the university first had a provost, and Brown was assistant or associate provost, whichever; the provost, James Adams, left, which left the university with an assistant provost, but no provost! So Brown was involved in the higher administration, and the interesting part of that for me was that through him I had a view of the thinking and operations of the university administration, not just the department or college.

Harlan Hatcher had already come to the university as president, and the job of provost disappeared and was not reinstated until Harold Shapiro became president, and now we have a provost. I can't be sure of the title now, but we did have a vice-president for academic affairs who was clearly the number two.

The Senate Advisory Committee on University Affairs and the Board in Control of Intercollegiate Athletics

In the mid-1970s I was first a member and then chairman of SACUA, which stands for the Senate Advisory Committee on University Affairs. SACUA was a sort of an executive committee of the Senate Assembly, the governing faculty body. SACUA was an interesting and educational experience, the first chance to become acquainted with the U–M administration, on a mostly friendly and cooperative basis. Robben Fleming was president at the time and Frank Rhodes was the vice-president for academic affairs, and they were both wonderful people to work with. Those three years on SACUA were preceded by three years on the Senate Assembly and there were many interesting debates. In the Senate Assembly, every academic part of the university is represented, proportionate to the number of faculty, and also includes representation from the Flint and Dearborn campuses. We discussed everything from the affairs of the Department of Intercollegiate Athletics to relationships with the regents. That's a completely different group. Those six years included some of the student activist years, as well as some of the more peaceful years. That was when the issue of disclosure of university salaries came up, which was certainly controversial, eventually taken out of the U–M's hands by the State of Michigan legislature. The advisory part of the faculty regretted that it would happen, but it was a regental and legislative decision, not ours.

I was also a member of the Board in Control of Intercollegiate Athletics, when Don Canham was still the director of athletics. I'm fuzzy on this, but I think

the official name of the Big Ten, now consisting of eleven schools, is the Western Faculty Conference, or something like that. The rules are very firm that the intercollegiate athletics must be under the control of the faculty of the universities, and Michigan had a Board in Control of Intercollegiate Athletics of nine faculty members, plus the director of athletics. Don was also a faculty member, in physical education, or whatever the title was. Then there are student members and alumni members, and for some reason the alumni consider being appointed to that as a very important prize. The faculty were probably the ones who attended the most regularly because others were out of town, so it was firmly under their control, and that was essential. Don Canham was very well known nationally and very competent in running a business.

The major issues that Don Canham brought were so logical and well thought out that we mainly modified them rather than rejecting them. One, for example, was the eventual dropping of synchronized swimming as an intercollegiate sport. That was one of the serious issues that took much discussion because at the time, with Title IX, we wanted to be very careful about any action that reduced the participation of women. Don Canham did not want to have any intercollegiate sport that did not have a national governing body for rules of competition. However, synchronized swimming was quickly replaced by other women's sports that had substantially more participation. Don Canham did a very good job of keeping President Fleming and the Board of Regents informed of all things that they should know, both in business and athletic matters.

Other U–M Activities

When Brown was dean and I was still fairly new, I was invited to serve on the College of Engineering Centennial Committee. That was 1953 or 1954, which was the 100th anniversary of the first degree in engineering, and that was Brown's personal celebration and that was a very happy event. Brown was still healthy and many of the distinguished people who came back were his own classmates from the 1920s. The event lasted two days. My particular job was simply to edit the book listing the citations for two or three honorary degrees and up to 100 regental citations. I think Brown was pleased. The sesquicentennial is now being planned by the dean and his staff. That will come up in 2004 and that, too, I think, will be even better.

I have had many other involvements in university-wide committees. One fascinating one was the Hospital Public Advisory Committee for the planning of the replacement hospital, requested by the director of the hospital, Jephtha Dalton. Most of the committee members were from outside the university, chosen by President Fleming and I think by Frank Rhodes, academic vice-president. It had interesting people on it such as Alfred Taubman, for whom part of the hospital is now named, Harold Abel, a psychologist who was president of Central Michigan

University, Rachel Keith, a lovely person who was an M.D. and whose husband was a federal appellate judge, Fred Veigel, who was secretary of the Washtenaw Huron Valley Council of Skilled Labor, plus the dean of the medical school at that time who was John Gronvall. But Jephtha Dalston did bring his problems on hospital planning to the committee. The replacement hospital was a tremendous project, the largest capital project in the state at that time, 280 million dollars, which must have left many of the regents worrying because they had to commit the university to that tremendous expenditure.

During the SACUA years, there was the very interesting Faculty Handbook Committee, to examine the status of the research faculty. That is a separate group of members of the university who have titles corresponding to faculty rank, but who report, not as faculty do, to the vice-president for academic affairs, but a group that is responsible ultimately to the vice-president for research, who at that time was Charles Overberger. The status of the research faculty has always been a concern because they are quite important in our research effort, but yet they do not have the privileges of the faculty such as sabbaticals, because these people all work essentially on soft or contract money, which is subject to termination and expansion, depending on the contract and research work the university does for industry and government. During my last year on SACUA, in agreement with Charles Overberger, we spent a summer preparing a handbook for the research faculty, which was modeled on the same outline as the handbook for academic faculty.

I was a member of President Shapiro's Inaugural Committee. The program in effect was preplanned according to university traditions. Members of the committee did really very little other than have their names on the program. That was incidentally a very happy inaugural. I remember several instances, particularly Saul Hymans, who is a personal friend and colleague of Harold Shapiro, remarking on the change in Harold. Namely, that as chairman of the Faculty Senate Committee on the Academic Status of the Faculty and as chairman of the Department of Economics Harold continually argued for more money for the faculty, but however, on becoming vice-president for academic affairs before assuming the presidency, he continually argued for more faculty for the money.

As a member of the College of Engineering Honors Committee, I first met Jim Duderstadt, who was new in the faculty of the Nuclear Engineering Department. The job of that committee was very simple, mainly to interview the students and choose the nominees for the various awards.

Thus, working on all these university-wide committees made it possible for me to know so many people in colleges and schools and departments that had nothing to do with chemical engineering, which was very nice. Most of this exposure came rather late in my career, prompted largely by election to the Senate Assembly in 1970 and an invitation to join the Rotary Club of Ann Arbor. But before that I

knew very few people.

My acquaintance in the city and other parts of the university really depended on my wife, Ruth, who was much more active in the city and university affairs than I was. She knew many more people than I ever did, even today. So many of my friendships and acquaintances depend on her activities, or are the result of all that she did in the city and county. She especially enjoyed her involvement with the Faculty Women's Club. She became president of the club at the time the Flemings came to Ann Arbor, so that was her first chance to become acquainted with that very happy, pleasant couple. That friendship with Sally Fleming and Ruth endured as Sally was very good at knowing so many people in the community.



George Quarderer. After his U-M Ph.D. in 1968, he spent his entire career with the Dow Chemical Company in Midland, Michigan, retiring as a research fellow in 2002. In 2000 he was one of four recipients of the Herbert H. Dow Medal, recognizing his "inventiveness and pioneering in technology."

Miscellaneous

As George Quarderer has said, the ideal chemical engineering student is one who grew up on a farm, and I think that is still right—someone who has had to live with machinery, repair it, and be inventive. The ones I admire are the ones who are imaginative and innovative because there is such a need for that in chemical engineering. Through the years I have known several really exceptional students. One is Jim Wilkes. I was not his thesis advisor of anything like that—he was everybody's student. Another one is Bob Kadlec, who developed a field for himself, which shows the versatility of chemical engineering. It involved the disposal of municipal sewage (after primary treatment to remove solids) on wetlands and marshes. After almost 30 years his first project—at Houghton Lake—is still going successfully at little cost; all of the municipal wastes are just pumped out into the swamp and nature takes care of the disposal and out comes clean water. He has written an important book in the field—*Treatment Wetlands*.



David E. Hammer and Bob Kadlec, 1988.

The American Institute of Chemical Engineers is the professional organization for chemical engineering. It was founded in the early 1900s, soon after the program in chemical engineering was approved by the regents. Chemical engineers also participate very strongly in the parallel organization, the American Chemical Society, which of course is much larger because it includes all the chemists, not just engineers. A.H. White, G.G. Brown, Don Katz, Stuart Churchill, and Joe Martin have all been strong presidents of the AIChE. Under the leadership of A.H. White—in 1922, I think, the AIChE recognized student chapters in universities and the U–M had the first such student chapter. We still have the charter certificate in the department.

In 1974, I was fortunate enough to receive the Stephen S. Attwood Award for service, which is now the premier award to College of Engineering faculty. It was a complete surprise to me. Dave Ragone, who made the presentation, had done a little bit of extracurricular work, and he saw to it that my wife, Ruth, and her sister were both in the audience for that presentation. At the present time, the acknowledgement of faculty achievement and alumni achievement is accomplished at two very nice evening events. In the fall, there is a black-tie dinner at which we acknowledge the achievements of alumni, one for each program in the college, each department and one overall alumni medal, and those have become very well attended, very graceful and pleasant events. In the winter, in February, there is a dinner dance, now very well attended, in which the faculty and research faculty achievements are acknowledged for service, research, and teaching, and we have watched those grow. I think they were started possibly by Gordon Van Wylen,

extended by Dave, and little by little, they have assumed more prestige and bigger attendance and become social events as well as excellent academic events.

Retirement

In 1983 I had a very beautiful retirement dinner that took place at the Michigan League, at which Jim Wilkes was the master of ceremonies. I had the great pleasure of seeing the group of graduate students that I have known well, back together, including Seymour Calvert, Bob Miller, and many others. One of the best parts was that Pete Lederman, assisted by Jim Wilkes, had organized an extensive campaign for contributions to a scholarship in my name. The great pleasure of that was the extensive number of contributions—perhaps broad rather than huge. The scholarship fund has grown over the years through added contributions, again from a wide range of alumni, to where the income from the endowment can completely support an in-state student for a year. More light-heartedly, I was presented with a canoe paddle, signed by everybody who was there, organized by George Quarderer, with whom I'd been on many very pleasant springtime canoeing junkets, along with Bill Hosford, Bob Kadlec, and others.

2—PEOPLE AND EVENTS BEFORE 1960

E.H. Leslie and G.G. Brown

To G.G. Brown and E.H. Leslie I would give credit for building up the graduate program at the U-M and for introducing the idea of strong and modern research. G.G. Brown was in the class of 1917 of New York University, which had a good undergraduate chemical engineering program. He worked for the Singer Sewing Machine Company somewhere in New York and came to Michigan two or three years after his undergraduate degree. I'm not sure exactly what his status was, whether it was combined faculty or graduate student, but he came here in the days of E.H. Leslie and got his doctorate here. The thing we remember about him is that he was imaginative, very competent, very persuasive. He had once said the most important course he ever took in college was debating and I can believe it.

Brown was a superb engineer and obviously successful at the university from graduate student through the faculty ranks to chairman of the department and dean of the College of Engineering and also assistant provost of the university. He had time for very active consulting, which he brought into the university. His research ideas came from his professional practice. He had an amazing ability to concentrate. He's one of the few people I knew who could really competently handle both faculty responsibilities and outside activities. For example, he was director of reactor development for the Atomic Energy Commission and he had the plain ability to do that and meet his university responsibilities together. He

had strong ideas, excellent ideas, I think, of how faculty should be raised and how faculty should behave. He wanted faculty with initiative.

Brown did not want us to ask permission to do things. He always thought it was easier to correct somebody for doing something he shouldn't have done than to stimulate somebody to do something he should do on his own initiative. Many times faculty, I included, would ask him if it was all right to do this or that and he said, "Don't you know?" He said, "Don't ask me for permission. If you think it's right, do it." Another favorite was when we would go to him with a question or permission to do something, and his frequent response was, "If I answer your question, you will be bound by my answer. Are you sure you want to ask that question?" And that was the sort of faculty he wanted to collect. His approach was partly, I think, a reaction to A.H. White's style of departmental management. A.H. White was inclined to get versatility in his faculty by giving each one of them a particular field. He did not want to see two or more faculty working in the same area of specialty in chemical engineering. Brown didn't worry about that as long as there were not too many of us in any one particular field.

Brown was an excellent mentor when I was a graduate student. He was exceptionally busy, but we never had to make appointments to see him. He had a superb ability to cut off what he was working on, and give full attention to a student or faculty or anyone, and then pick up his own work. He listened well. I remember many times going into his office while he was dictating, which he did very fluently and easily, much more so than I could ever learn. He would cut off his dictation, talk to me or to any other student at whatever length we needed. He never seemed to be hurried or anxious to get us out, and then as leaving, I would notice he would pick up his dictation and continue with the same sentence!

Brown was the reason we came back here. He helped me get the job with the company I worked for. We were broke so we had to leave here, with all but the dissertation completed.

A.H. White

Most were still on the faculty when we came back, except McCabe had left and Baker had died. A.H. White was a very distinguished-looking professor. He had had quite a standing as one of the early people in chemical engineering. There were only possibly three departments older than Michigan—MIT, the University of Pennsylvania, and possibly one other. We were founded in 1898 and A.H. White was probably the first real chairman, until his retirement in 1943, which was quite a long tenure. He was rather gentle to the students. He represented, in his teaching and research, the beginning years of chemical engineering. His research was not really the modern type of chemical engineering that developed in the late 1920s. He was a good chairman and he certainly built a good department. He had a large personal influence in engineering materials and wrote probably the first textbook

in that field. I suspect he was something of a tyrant in running the department. Students were not always aware of those things, but I would say he came closer to being a head of the department than his successors, who were more chairmen of the departments.

White tended to make some decisions by himself, which is a good thing because a leader can't be too democratic. His wife, Rebecca, was a Colorado native and had strong roots in Colorado. I was just about the only one from Colorado here. We became good friends. Although I had relatively little contact as a student with A.H. White, he certainly knew who I was and it was that kind of a department. All of the faculty knew all of the students. White had also held the rank of colonel in the Ordnance Department, I believe, during World War I and he was responsible for continuing the relationship between military services with faculty and students. There were several of us who were commissioned in the Reserves while we were students, primarily because of A.H. White and J.C. Brier to some extent. Brier, Alan Foust, and a few others, were all in the Reserves. They were called back to active duty for World War II. The department had quite a bit of involvement or relationships with the military because of that.

E.M. Baker

Edwin Baker was a person I liked very much and admired. He was an excellent teacher. He devoted one day a week to his consulting work, which was with the Hershey Company in Decatur, Illinois. Every Tuesday night he would go down to Milan and take the Wabash train, which went through Decatur, Illinois, spend all day Wednesday consulting and take the train back Wednesday evening. He scheduled all his classes on a Monday, Tuesday, Thursday, Friday basis and he never missed a day consulting nor a day of class. He brought his consulting problems into his teaching and research. Unfortunately he died rather early, in 1943, I think. He was heavily engaged in war work. The company he was working for was one that made the diffusion barrier for the separation of uranium at the Oak Ridge Plant. He undoubtedly had a strong part in that. He liked unannounced quizzes and there was a student saying that his initials "E.M.B." stood for "any moment blue book," but he was one of the fairest and best teachers ever.

Baker had a strong part in shaping the nature of chemical engineering teaching and industry. To oversimplify, early chemical engineering teaching was structured around industries—the dye industry, the chemical industry, the photographic industry, and the petroleum industry. It was as much technology as anything. But as it grew, probably one of the best inventions ever in chemical engineering was its treatment of the so-called unit operations, in which chemical engineers choose the things that are common to all industries (such as evaporation, distillation, and reactor design) and emphasize the instruction of those rather than the technology of a particularly industry. So, there was this transition from the technology to

modern engineering and Baker and Badger wrote a book about that, which really gave more impetus to the modern trend of being more scientific or mathematical and less descriptive. So Baker, in his teaching, gave that aspect of chemical engineering a strong start.

J.C. Brier and Alan Foust

John Crowe Brier or “Jack” was one of the very earliest faculty members in the department. He was of British origin. He was the one who would rather have been at the World Series than teaching us. He was friendly, colorful. As a colonel in the Reserves, he is another one who had to return to active duty during World War II. He was friendly and lovable. His students really liked him. He had a large research project for extracting oils, essential oils, possibly for pharmaceutical purposes, from seeds, parsley seeds, carrot seeds, you name it. He also did a lot of work in the extraction of sugar from sugar beets, which was, of course, of use to the Michigan industry.

Brier had some odd projects. There was a period, in the 1930s, when the tobacco industry was very strong in southeastern Canada and there was also an extensive agriculture and still is today in the growing of beans and soybeans in southwestern Ontario. There was something about the soil’s high copper content that prevented the use of some of the lands for growing edible beans, and Brier had a couple of projects on that. The exact nature of them I don’t know, but he had started to get us into a completely different field of chemical engineering involving food and the pharmaceutical industry and that, I suspect, was cut off because of his activities in World War II. We did not get back into pharmaceutical or food or bioengineering until after the war with another faculty member, but Brier was kind of the old-fashioned chemical engineer, not the modern scientific one, although his doctoral students were capable of excellent scientific and modern chemical engineering work, and he did somehow earn the love and affection and respect of all of his doctoral students. He liked to play bridge, he and his wife. I suspect that he never really recovered from the death of his wife. He lived alone in the Michigan Union in his later days.

Alan Foust and I started our graduate work in the same year. He was somewhat older because he had worked in the petroleum industry in Texas and he was, and remained, a Texan all of his life. He married an Ann Arbor girl and stayed on the faculty. He too went into the military and I think he worked at the Pine Bluff Arsenal where Brier was stationed during World War II. He came back after the war and was interested in following the work of Badger. Alan was a good friend. He left us to become chairman at Lehigh University in the early 1950s and we had kept in touch until his death. So, he was both a colleague and a fellow student. Also, as a comment on the nature of the university, Al was probably 30 at the time, and self-supporting. He wanted an apartment rather than a room in a

rooming house in his later graduate student years and he had to have a note from his mother proving that he was living in an apartment rather than a supervised rooming house. Al's another one I wish had stayed. He was never without his coffeepot or his pipe and his health paid, not for the coffeepot, but his pipe.

Warren McCabe and Walter L. Badger

Warren McCabe was another superb teacher and his warm-hearted approach was the eye-opener to me when I came here. I had known of his textbook, Badger and McCabe's *Elements of Chemical Engineering*, in Denver. Next to G.G. Brown, McCabe was the one who took the most effective personal interest in me in my first year, and I later had the chance to work with him after leaving the university. He was a very much admired person and I thought very kindly of him. He left here at the end of my first graduate year for Carnegie Tech and from Carnegie he went back to industry and was director of research of the old Flintkote Corporation. He had other jobs during the war and I saw him frequently because he was in the New York area and after some time at the Polytech Institute of Brooklyn, he ended his days at North Carolina State on the faculty as a kind of elder statesman. He, too, was a modern teacher, with good professional practice and good research.

In the textbook business it was Badger who was the leader, although in that book McCabe's contributions were far more enduring and still are. After McCabe left, each of them wrote a following volume that might have been called a second edition. Badger wrote with Banchemo, one of our students. McCabe by that time was at Cornell and rewrote the text with one of the Cornell faculty, so the textbooks are still in business today, especially McCabe's.

Badger had the rough tongue. Graduate students either dreaded him or liked him. He had me cowed, of course. There was one episode in class that was a traditional legend, but one that I later verified. It happened shortly after the veterans from World War I began arriving on campus. Badger was picking on one of the students—John Dickinson. Badger had a habit of picking on people whether he took a dislike to them or what, but he would hound a student in class. Brown would also pick on students in class, but that was a sign that he liked the student and was trying to develop him. With Badger it was, I'm afraid, some sort of animosity and it reached a climax one day in class. Badger said, "Dickinson, in every class there's one son of a bitch, and in this class it's you." And Dickinson, who had served as an enlisted man in the navy, was a couple of years older than most students, would take none of it, and he stood up and said, "Professor Badger, in every university faculty there is bound to be one son of a bitch and in this university that's you." I worked with John Dickinson. He was one of the senior engineers at Kellogg and I asked him about the truth of that, and he said, yes, he just wasn't going to take it from Badger and he spoke back, and he said that seemed to clear things, and from then on they were reasonably

friendly. There were very few students who would stand up to Badger. Most of us said, yes sir, in class or out, but he was a good engineer of the old fashioned kind. He knew how to get things done. As a teacher his technique was, go out in the lab and find out—work it out for yourself, but he was exacting and tough. He wanted performance.

Albert E. White, Donald McCready, William Platt Wood, Clair Upthegrove, and Richard Schneidewind.†

I knew Albert E. White when I was on the faculty and he was director of the old Engineering Research Institute. His idea of industry-sponsored research at the U–M—and this was 1923 or 1924—ultimately had an enormous and far-reaching influence. It was the genesis of the modern research university and it was just such a little thing when he started it in the mid-1920s. He was on the departmental faculty, and it was his idea of using the university facilities and faculty for industrially sponsored research that would benefit both, and would improve the quality of research and teaching, especially in engineering. As you would expect, there was considerable opposition to his idea.

As I learned from Dick Crane, some early important projects were in physics, in which Edsel Ford got in the acoustics groove, and convinced a Professor Firestone and one other in the Physics Department to find ways of making a quieter automobile. Edsel Ford's father, Henry, disapproved of research, and Edsel had to sneak it through somehow. He personally started this and was responsible for the dead room that used to exist in the sub-, sub-basement of the Rackham Building. Thus, the formation of the so-called research universities started in the East Engineering Building or in the old Chemistry Building. It helped so many students to earn enough money to stay in school and also to prepare for the benefits of working with industry and government later.

In my student years, Albert E. White was involved so completely in research administration that he did very little teaching. A.E. White had helped to start the program in high-temperature metallurgy, which was possibly the very first university research program—sponsored or otherwise—in that business. So, I knew him through that and also as a research administrator. I later knew his last wife, Elsie, somewhat better.

Donald McCready was one of the teachers in my first term at the university; he taught an excellent course, the old ChE 2 (our first required course). As a faculty member, I learned later that ChE 2 was the most difficult course in the program. The reason was the high workload that resulted from a conscious decision by the faculty to make ChE 2 a deliberately hard course and use it as a sort of a “weed-out” for the students. The intent was not so much to discourage them from

† This section is dated 3 February 2000.

taking chemical engineering, but to provide some sort of a performance barrier; for many years a minimum grade was required in that course to continue in chemical engineering. The result was that ChE 2 had an exceptionally high workload.

This introductory course ended with a 48-hour power-plant assignment and had a laboratory. It was an immense amount of work for a three-hour credit, but it was an excellent course and McCready thereby earned the reputation of being a very difficult and exacting teacher, which really was not his nature. McCready was a very bright and exceptionally competent person, but his career was hindered by bad health involving tuberculosis and lung cancer for so many years. Thus, he possibly never did really reach his research potential, but I always thought of him as an excellent teacher with an unfortunately hard reputation—fair but difficult. His field of research was in the pulp and paper industry and he was quite competent and well-known in that area. Pulp and paper were and are still important industries to the State of Michigan.

Then there are two more faculty members whom I always think of together: Clair Upthegrove and William P. Wood, known as “Platt” to his friends. Those two persons were possibly the only faculty members ever in the department who had been educated as *teachers*. They both had gone through schools of education and they were excellent teachers and were both metallurgists. At a time when the department was combined, all chemical engineers took courses in metallurgy, which contributed greatly to the breadth of Michigan graduates. It was quite common for students to earn degrees both in metallurgical engineering and chemical engineering. G.G. Brown always considered us to be *one* kind of engineer—chemical *and* metallurgical, which were our academic titles, not in one or the other, but in *both*.

Both Wood and Upthegrove were lovable. Now, I’ve taught courses in different combinations with Platt Wood and Lou York. Of the three, Lou York and I thought we were the young, hotshot teachers and that Platt Wood had the appearance of being a very easygoing old teacher. However, when we taught three sections of the same course together and gave common exams it was Platt’s sections who were always clinically and statistically better than ours and so we learned from him! Whether it was his kindness or whatever, he’s another one of the faculty that students liked very much. He was not greatly interested in research, but he *was* interested in teaching.

Clair Upthegrove, whom I couple with Platt because they were excellent and close friends and taught the same courses, was a little more exacting teacher. Especially in the laboratory section of metallurgy/metallography, in which we polished and etched samples and then examined and analyzed them under the microscope, Clair was one who insisted on perfection in laboratory techniques. Consequently, some of his graduate students had outstanding careers in metallurgy and were responsible for the immense influence of the University of Michigan in high-class

metallurgical work in places such as the old International Nickel Company or the Aluminum Company of America and some of the stainless-steel companies. There is no doubt that we were one of the premier institutions in modern metallurgical engineering.

Richard Schneidewind split his time between engineering research duties and teaching. He was probably half-time in each and was one of the smoothest lecturers I have ever known. I taught a course with him and attended his lectures. It was the old ChE 1, which was a course in materials required of all engineering students as freshmen. I just marveled at his ability for smooth delivery, coherent presentation, and clarity of exposition. When I was a graduate student, he was one of the younger faculty. He too suffered from a career shortened somewhat by bad health. He ended his career helping the university to establish a program in engineering at what amounted to the Brazilian Air Force Institute, which would be their counterpart of our Air Force Academy. He spent two years in South America at the end of his career getting the materials program started at that institution.

Donald L. Katz

I worked with Don Katz first when I was a student and later on some research projects when I became a faculty member. I knew him as well as anyone on the faculty other than G.G. Brown. Katz was the first of Brown's doctoral students to come back to join the faculty of the university and so I knew him in several of my capacities: as a student in his class, as a student who worked on research projects for him to support myself in graduate school, as a faculty member teaching courses with him, and as a friend.

As a young assistant professor back in 1936 when he had just returned from his three years at Phillips Petroleum, Don Katz was eager and as hardworking as anybody. Al Foust (who was ending his last year of graduate study and about to be on the faculty—at that time, Al and I were the only ones who continued at the university) and I and some other classmates both took Don's graduate course in petroleum production, which was taught in his second semester at the university. As an illustration of his zeal and willingness to put the load on us I would refer to his first final examination given for the course. In the Engineering College those examinations were, in contrast to the Lit School, four hours long, not three. Ours began at 8:00 AM and lasted until noon and was extended from 2:00 in the afternoon until 6:00 PM, when Don Katz came back to collect the exam. No one had left! No one was close to leaving! Don asked if we would like a little more time, and everyone agreed that we would. Don returned at 9:00 PM and picked up the exam. No one had yet left, but he collected it up anyway. Does that give an indication of how he piled the work on?

Don Katz was just full of his new experiences from Phillips Petroleum. Later, I worked for that company and I was introduced to the *two* people who were hired to

replace Don—one wasn't enough! He worked hard in the tough days of the oilfields and petroleum production. Two graduate students who became very good friends with me were Harry O'Connell and Jim Wiegand. We worked for Don Katz on a grant he had to compile properties of petroleum hydrocarbons. His workday was ten hours. We came to work at 7:00 AM and left at 6:00 PM, with an hour break in between, but there was no doubt that we were productive under his guidance and supervision. He did the same thing with his students in his graduate classes. He always found ways to give them extra assignments and to make them eager to accept those extra assignments. He has certainly left his influence. I wish it were still around.

I had a 35-year connection with the Phillips Petroleum Company because of Don Katz. He introduced me to them. It meant that I was associated constantly with real problems, not just research in classroom work. Engineering has changed during my years, and this is either not so necessary, or we are now content to have less of the industrial attitude. It meant that my interest was in the creative part of engineering rather than in the exploratory part. I think of scientists as being the explorers and engineers as being the creators, with no sharp dividing line between the two. Scientists are the ones who explore the laws and get the fundamental information. Engineers are the ones going to use it, but where the scientists do not get the information, the engineers must. To me, the design and construction and operation of chemical plants is the creative part, and that was what was interesting. Katz realized that engineers in industry can't wait for complete information. We have to go ahead anyway. That's what makes it so exciting and that's what leaves problems for research. We used to have, and we still do have, a group that meets, in which some of us put together a little documentation of major engineering mistakes, the disasters that resulted from insufficient information. That is where research ideas start, everything from bridges falling down to plants blowing up and other less disastrous mistakes.

In the early 1950s or late 1940s when G.G. Brown was the chairman, there were several other faculty leaders. Don Katz clearly was one. He had fairly broad activities both in engineering and in the community. We turned to one another among the younger faculty for technical guidance, but for personal or professional advice, I think we would turn to people like Platt Wood, Clair Uptegrove, or Don Katz. Don seemed to be a little bit apart from the rest of us in experience.

When Don Katz was appointed as chairman in 1951, there was no search committee, nor a meeting of the whole faculty to vote or discuss it. It was Brown's decision, as far as I know, after talking with individual faculty. Don was one of the last chairmen to be appointed without term. Well, for one thing, Katz was closer to us in age and he was perhaps accessible for anything, but perhaps a little less so than G.G. Brown. In fact, we felt that Brown was never inaccessible—he was just so organized that you could interrupt him at any time and he did not give

us the feeling that we were interrupting him. I suspect that with Don Katz we were a little more careful in approaching him when he was busy, but he was always quite accessible. I think, it's hard for me to describe him. Katz was not the strong chairman. He wasn't quite the master teacher, so our attitudes toward him were a little bit different. I learned later that Don was a rather wise man in the judgment of people and advising. Don probably tried to do a little more development of his young engineers than Brown did. Don Katz was very good in looking for opportunities outside for his faculty for consulting work, for professional work, for committee work. Don was incredibly loyal to his graduate students, and I think he probably spent more time with his graduate students than Brown did, although Brown was never short of time. The main differences between the two men was that Don was not the persuasive debater that Brown was, and was probably a little bit more likely to be a little bit more democratic in the department.

I always couple Don Katz and G.G. Brown together. Both were leaders. Brown probably disclosed less of where he wanted to go and what he wanted to do until his later years, when his health was very bad, and he began to realize the shortage of time. Brown did as much or more than Don Katz did in his research benefiting the industry, but Brown's premature death prevented his getting the same recognition that Don Katz did, which is, for his family's sake, regrettable. It's fate. In relation to Don, one of our more prominent engineering alumni who has stayed in active engineering with the Dow Chemical Company was George Quarderer and he came back once to interview students. He gave us a little talk at one of the chemical engineering seminars and he described his idea of the perfect background for a chemical engineer and that was to have grown up on a farm, which Don did, and Don did many things. His curiosity showed even then. He showed me one of the lakelets at an entrance to Clear Lake in Jackson County, a ditch that he had dug, making an entry to a little boat mooring from Clear Lake. He had spent a day with a horse and drag-plow or whatever he used and excavated a ditch that is still used today in between the little dockage and boat-rental business and Clear Lake. He snooped around in the woods on his family farm and discovered a morel pit, which supplied lime for the family farm for years. So, he was curious, hard working, and inventive all his days, even as a farm boy.

As a student, Don Katz worked very closely with Brown, and I'm just recalling a little anecdote that Don told on himself. Brown had a very strong voice, so did Don Katz. They had a suite of offices, four offices, and Katz was at one end, Brown was at the other, and four of us graduate students worked in the two offices in between. Brown would come in and start a discussion or vice versa, then they would separate and then go on talking to each other four offices apart, both in very firm voices. Brown always picked up a microphone and set it aside. Donald Katz could do the same thing, but Don told me once with a benign little smile of his that A.H. White followed Katz into his office once and said, "Don, you know

G.G. Brown is an excellent teacher, but it's not because he talks loudly." So, Don was able to tell that on himself, but I would say that there may have been a little bit of Don talking loudly to enforce his arguments, which Brown did not need to do. As graduate students sandwiched between Brown and Katz, we learned lots! Katz's style was not that of a strong leader, but more that of a colleague.

Don Katz's research ideas came from his consulting with industry. Almost every single doctoral problem he had—and he had a well-organized sequence of them—originated from some current problem in industry. The result was that Don's research was used immediately and it was sometimes waited for in industry. This was Don's reputation in the petroleum industry—that his research was usable and understandable. He is, I believe, one of the two of the university faculty who were awarded the National Medal of Science. James V. Neel was the other one. Don had the policy of publication. He was very good at getting his information out. He believed in publishing in two different levels, publishing the same work for two different audiences: one was the classic research journal, and the other was the trade journal, where he put forth the same material, but written and presented for two different audiences. In this manner, he guaranteed that his research was not lost and was used. In today's world, research is so likely to be lost if it's not used within three or four years, but Don was a master of supplying information when and where needed. In this respect, G.G. Brown had the same outlook.

Don Katz had at least one outstanding attitude toward his graduate students. He believed in working with them. He believed that as a research advisor he was also an instructor. He believed that it was his responsibility as a faculty member to improve, to guide the learning, to ensure that the graduate student or any student left the university far more competent and educated in every respect, and this appeared so many times in the industrial work in which he involved his students. He didn't mind taking students who might appear a little bit slow or less bright than some of the others, because when he finished with them, they were invariably as good as anyone and fully competent to do a research job in industry.

Brown and Katz both had the same attitude toward graduate students. Brown brought them into his consulting activities. In some ways Don Katz was Brown's creation, and I think Katz reflected much of Brown's abilities and attitudes with perhaps a slight difference. Brown didn't follow the student as closely as Katz did. Brown depended on students seeking his help when needed, whereas Katz was more inclined to give closer supervision. No doubt Brown would have stepped in if he thought things weren't going well or needed it, but he, too, liked to develop student initiative. I had the choice as a graduate student in the field I wanted to work, and I chose G.G. Brown as my advisor, mostly because I admired the man. I would also add that at my student time, Brown was the experienced teacher, and Don Katz was still in his first two or three years of university experience, and Don was more inclined to work with the students. Don still liked to get his hands on

the laboratory equipment and use it himself.

Don had extensive public service. He served nine years on the Ann Arbor Board of Education. He was exceptionally active in his church, and heaven knows how many things he did that he didn't talk about, all in addition to his professional society activities. He was well recognized by professional societies and others with their many awards, medals, certificates, and so on.

One of Don Katz's research projects. Let me talk about one of Don Katz's research projects. I had been doing a little work with him in the early to mid-1950s, but mostly he was doing laboratory work with Riki Kobayashi, who was a graduate student from Rice University and who subsequently returned to Rice, where he had a rather distinguished career as a faculty member. The problem involved the proposed construction of a plant in northern Kentucky—Gatlinburg, I think, where one of the major pipelines went through an area suitable for chemical plants. The idea of the project was that the natural gas coming from the fields of Louisiana and Texas on its way to the east coast would be cooled at the pipeline pressure to a low temperature of around -120°F or -130°F , at which point substantial quantities of the heavier hydrocarbons—principally ethane—would be condensed. Without harming the heating value of the gas the liquid ethane would be removed and would be the basis for a chemical industry producing such things as ethylene glycol and materials used in making polyethylene plastics, which were growing tremendously at the time.

Well, the design of the plant was set. All of the equipment was ordered. The plant was under construction and one of the management or design engineers of the plant thought it would be a good idea to make a final test. So, they sent some samples of the natural gas in the pipeline for Don Katz to make a quick laboratory test—to cool the sample down to -120°F or so, just to verify and analyze the composition of the liquid. Katz, working with Riki Kobayashi, cooled the sample at the pipeline pressure down to those temperatures and there wasn't one bit of liquid in it! So the next morning, after Katz had told them the news, there was a delegation of men in business suits all clustered around in the laboratory, and that started an exhaustive exploration of the liquid/gas relationships and compositions of the phases for that particular gas. It resulted in the expansion of Riki Kobayashi's experimental work for Katz, and a complete revision in the refrigeration system for the plant. The result was an increased exploration of the liquid/vapor phase relations in natural gas systems. This was just one example of Katz's policy of doing research of immediate value.

The other interesting thing about this research is that I don't know whether we could do it in the same way today or not, with our present system of controls. All of Don and Riki's work was quite properly done without formal contracts, but with the normal consulting relationships. Don did quite a bit of this, with industries bearing the expense of paying the graduate student for his time, but

Don always exacted something from industry for the university. In the case of Riki Kobayashi and that particular search for the Light Line Company, he bought some equipment for the laboratory, which remained in the laboratory, but was paid for by the company. The university always benefited, but at that time we had that ability to work quickly without the weeks of negotiation needed for setting up formal long-term contracts.

In that same period and using somewhat the same apparatus, the gas industry had a problem of very small traces of heavy hydrocarbons—hexane, heptane, and heavier—appearing in wintertime as condensate in natural-gas transmission lines, and collecting in puddles somewhere and intermittently coming through to burners such as boiler plants. In other words, during very cold weather, an unanticipated bit of liquid might form, and that liquid would come through as a slug and cause enough upset that instead of a short burner flame in an industrial plant, there would be a big one, which would make some plants disastrous. But another doctoral student gained work in exploring the condensation of very small traces of the heavy liquids, so that cleared up one of the remaining problems for the natural gas transmission business. Again, a very serious industrial problem that was cured by fundamental information.

Brown's "Brats"—Lloyd Brownell, J. Louis York, Julius Banchemo, and Cedomir Sliepcovich; R.R. White

Let's turn to a group of four professors who were appointed to the department in the 1940s and 1950s. Collectively they were known as "Brown's Brats"—Lloyd Brownell, J. Louis York, Julius Banchemo, and Cedomir Sliepcovich, all graduate students at the time. They came here in diverse ways. Lloyd Brownell was a mechanical engineer who had graduated from Clarkson Institute of Technology and he came as an engineer associated with the Baker Perkins Company of Saginaw, on a project directed by G.G. Brown. The project incidentally showed Brown's diversity. Its idea was to find a way of inducing the shine on the loaf of bread crust by controlling the temperature and humidity rather than dousing it with butter. So, we had a miniature bakery set up on the third floor of the East Engineering Building, operated by Lloyd Brownell, turning out several loaves a day with thermocouples attached to the crust and other various instrumentation. Lloyd and Brown kept us graduate students supplied in bread for about a year or more on that project. Well, Lloyd stayed while working here on that project and earned a doctorate in chemical engineering.

J. Louis York had come here in the fall of 1939 as a graduate student from the University of New Mexico and stayed here until 1970, when he left for industry. Julius Banchemo was a graduate of Columbia who was teaching at the University of Detroit and came out here for graduate studies. He, too, was drafted by Brown to our faculty. Cedomir Sliepcovich was from Anaconda, Montana. He came here for

graduate studies and was the fourth of the Brown's Brats drafted for instruction. He was a thermodynamics scholar, an excellent teacher, and very popular. He left us for the University of Oklahoma in 1955.

There's also Robert R. White who came here as a graduate student in 1938 from Cooper Union. He was a brilliant person. After completing his doctoral work he went to the Universal Oil Products Company, a company engaged in research and construction in the petroleum business. He showed an interest in moving from there, and Brown brought him back shortly after Brown became chairman. He was a brilliant teacher, and very active in research. There are more interesting aspects of that. He was the one who built the Michigan Gas Fellowship. It was a fellowship sponsored by the Michigan Gas Association, which was an organization whose members were all in the Michigan gas industry, and Bob White, working with that, built that from just a single graduate fellowship year into a major research project for as long as the Michigan Gas Association endured. That particular fellowship was interesting because it was one originated by A.H. White and was probably the oldest industrial fellowship in the United States at the time. Bob White was interested in administrative work and he was an associate dean for the Rackham School of Graduate Studies. He left us for industry to become a vice-president of the Atlantic Refining Company and he has spent most of his career in industry and administration, also closing it in Washington for several of the semi-governmental agencies.

Joseph J. Martin, Edwin H. Young, and Maurice J. Sinnott

Then there is the next group. Let's lump them together: Joseph J. Martin, Edwin Young, Maurice Sinnott, and I who all came here within a one-year span. In order, Maurice Sinnott came, I believe, in 1946. He was a combined chemical and metallurgical engineer and he came back on the faculty of metallurgical engineering, staying here until his retirement. He has done many interesting things, particularly including a government project for ARPA, the Advanced Research Projects Agency of the Department of Defense. That was a project that endured for 25 years, and he later became one of the directors in the Department of Defense on a two-year leave. Edwin Young is a graduate of the University of Detroit and he spent the war in active duty in the navy. In that connection, he maintained his rank, and ultimately retired, as a captain, a four-striper in the Naval Reserve. He was teaching at the University of Detroit after the war when he met G.G. Brown, who employed him rather quickly after their first meeting, to come to the university to teach design. So, he came in the summer of 1947, earned his graduate degree in chemical and metallurgical engineering, and stayed here until his retirement somewhere in the 1980s. He, too, has had an interesting career as a member of the State Board of Registration of Professional Engineers and Architects for twelve years. Joe Martin was a graduate of Iowa State University with his doctor-

ate from Carnegie Tech. He, too, came in the fall of 1947 and his love and really his only and consuming interest was in teaching thermodynamics. He had had a brief experience at the University of Rochester before completing his doctorate at Pittsburgh. He stayed here until his premature death in 1982. He, too, was one of the Michigan faculty who served a term as president of the American Institute of Chemical Engineers.

Two Graduates from MIT

There are two other whom I will couple because they were close friends. They had gone through graduate school at MIT together. They were both metallurgical engineers. They were David Vincent Ragone and Edward Hucke, and they came here at almost the same time. Ed Hucke stayed until retirement. Dave Ragone left us after a few years, after both of them had reached the rank of full professor. Dave left for industry, where he worked for General Atomics on various aspects of their power generation. He left that for successively Carnegie Institute of Technology and Dartmouth College and he left Dartmouth, the date I can't quote exactly, but he came here as dean of engineering as the successor to Gordon Van Wylen. He left us after his term as dean to become president of Case Western University in Cleveland, retiring from that position to a professorship at MIT. Ed Hucke stayed with us for his entire academic career. He was one of the early researchers in the use of carbon as a filament in such things as reinforced plastics and carbon as an industrial material of construction. Ragone and Hucke were both stimulating teachers, especially Ragone with his very happy manner in classes was an excellent teacher. I miss them both.

The Chemical Engineering Curriculum

When I returned in 1947, significant changes were occurring in the curriculum. The original teaching of chemical engineering was built around chemical technology and the chemical industries. The evolution by chemical engineers of thinking in terms of "unit operations" was called by Ralph Landau—a prominent chemical engineer—one of the major inventions of the millennium. In "unit operations," the instruction, organization, study, and research in chemical engineering was built around operations that were common throughout chemical technology, such as the processes of separation, distillation, crystallization, fluids and flow, reaction kinetics, and so on. It was during Brown's term that the final transition from chemical technology to the unit operations approach was completed. The development was gradual, and—as the industry grew and faculty changed—the unit operations field expanded. That was especially emphasized by the publication of the book written by G.G. Brown and his eleven disciples, *Unit Operations*.

In the early 1950s enrollments in the undergraduate classes were surprisingly low, and this we attributed to a Bureau of Labor Statistics Report that predicted

rather a gloomy future for engineers! The enrollment in the undergraduate college probably sank to the level of 30 years earlier, and our undergraduate classes were as small as 15 students. The graduate classes, comprising mostly mature and friendly groups of G.I.s, were large, but they were easily handled.

Brown’s “Unit Operations”

The *Unit Operations* book was under way when I returned, existing in the form of notes, which were used and tested in classes throughout the program. These notes were written by everybody. There were certain chapters that were written only by individuals such as Bob White, who did most of the mass-transfer part. Lou York handled most of the early courses, but then everybody pitched in, and there are some chapters in which there were several hands. As we looked through the book at the time and today, the best chapters were those that were written first and tried out in the classes and then revised by the group. There’s no doubt but that the master hand was G.G. Brown. He was both an author and an editor, and his wisdom usually prevailed. Brown, like many strong leaders, didn’t always disclose everything and he left more written records of what he proposed to do. But there is no doubt that one of the purposes of the textbook—in addition to producing the first new chemical engineering textbook in almost 20 years—was to bring our young faculty together in a cooperative effort, and, in that, Brown certainly succeeded.



George Martin Brown.

I came in at least a year after the book was started. Really, it was my good friend Lou York, I think, who laid the ground to let me participate. The only

author not then at Michigan was George Martin Brown, who was G.G.'s oldest son, who at the time was teaching chemical engineering at Northwestern. The indication of the sharing probably was reflected by the division of the royalty payments by the publisher, John Wiley. As I remember, Brown's share was either a quarter or 30%, which probably was somewhat less than his total effort. The next one was Lou York. I think his share was 15%. And I think that without those two, the book would probably not have been written, certainly not without G.G. Brown, who was the driving force and the coordinating effort. He spent many hours in his office going over the text, and there were several of us at the minimum, which was 5%; I was one of those. I was grateful being able to participate in the book and Bob White probably was somewhere between Lou York and the minimum. The book was amazingly successful because the country was ready for it. Previously, there were *Principles of Chemical Engineering* from the mid-1920s at MIT and Badger and McCabe's *Elements of Chemical Engineering* from Michigan, and nothing really new since then.

Al Foust, as I mentioned, left for Lehigh, where a group of at least two faculty from Michigan wrote another book in chemical engineering, which I would say was at the same level and same organization as Brown's book. There were also additional books—one from Cornell, McCabe and Smith's *Unit Operations of Chemical Engineering*, and another one written here by Badger and Julius Banchemo. So, McCabe and Badger each produced editions after *Unit Operations*, but separately with new co-authors. That concept lasted until the University of Wisconsin chemical engineering group came out with another really innovative approach to the subject.

The Department's 50th Anniversary

Soon after I arrived back at Michigan, the department celebrated its 50th anniversary, in 1948. A large number of the alumni returned for it, and also again 50 years later for the 100th anniversary. I can't quite be sure, but there was a short period in which A.H. White experienced three celebrations—the 50th anniversary of his department, his 50th wedding anniversary, and his 80th birthday. It was, I think, his 80th birthday and his 50th anniversary that came in the same year, but, shortly before that, was the 50th anniversary of the department. There were fewer schools then teaching chemical engineering, so it was possible for a young engineer to meet some of the many star figures that came to the 50th anniversary celebration. The total membership of the AIChE was probably closer to three or four thousand then than it is today at 40,000 or 50,000. It was a good thing for the department to be together at the same time that *Unit Operations* was being written. Just another wonderful opportunity for togetherness and coordinated effort.

Many of my fellow graduate students came back for the reunion. They were

both in industry and at universities, and many had a strong influence in teaching. A number of the departments of chemical engineering were expanding and strengthening, and at that time there were somewhat more than 100 Michigan graduates teaching somewhere in American/Canadian universities and a few in India. That was the time when Michigan, Wisconsin, and MIT had a very strong influence in the growth of chemical engineering. Then, there were probably 40 or 50 accredited schools or programs, but now there are 100 more than that.

Promotion, Tenure, and Faculty Meetings

I became an assistant professor in 1948, and was given tenure and promoted to associate professor in 1950. Promotion and tenure decisions were much less formal than they are now. The senior faculty discussed the matters of advancement, and I think the chairman made the decision afterwards. Whatever was agreed upon was submitted to the dean and the Executive Committee of the college, and they made the final decision. Now, recommendations are made by an interdepartmental promotion review committee, which submits a report to the dean and the Executive Committee. I think it is probably a little more difficult now, although our new faculty are given far more generous “start-up packages” than before.

I remember the faculty meetings that took place when G.G. Brown was the chairman of the department. Brown frequently turned jobs of revision of procedures, such as the doctoral qualifying examination, over to the younger group, rather than the senior group. I remember so many times that the suggestions coming from one of the younger group were greeted with a smile or silence by some of the senior faculty. Obviously, they'd seen all this before! Brown was a good chairman. He controlled the agenda, but didn't bring things up before the faculty were ready to discuss them. Brown was the sort that encouraged full discussion, and he was a master at controlling the timeliness of any agenda. If he knew where he wanted us to go, he didn't tell us. He was that kind of leader, but he asked for full information before any decisions were taken. He always wanted well-considered proposals. He liked initiative to come from the faculty. He was a superb leader and a strong one; looking back it was democratic up to a point, but there was no doubt who had the final decision and authority. Brown was a most persuasive person, both in his personality and in the logic of his arguments. So, if we opposed him, he could be very persuasive and convincing. I wish Brown had been chairman a little bit longer so that I would have seen more of him. He became our dean in 1951.

Most of our faculty meetings were informative. The one thing I don't suppose we ever knew, is what decisions might already have been made. What might Brown have considered administrative details and what would he bring to the faculty for discussion? That showed a little more clearly to me when he became dean and had a formal executive committee for what he considered administrative decisions

and what should be faculty decisions. The one thing he was, was very open. No hidden maneuvering. If there were, we didn't know about it, and I always felt as if he told us everything, and certainly everything we needed to know. The policy of regular weekly faculty meetings had been established by A.H. White and was followed by G.G. Brown and Don Katz.

Social Aspects and Congeniality

In my early years the faculty was a very friendly group. We needed each other. The young group were all in the same spot. Inevitably, I suppose that closeness changed some, as Ann Arbor grew, and as we became established and developed other community and professional activities. The department was never one that was highly social. During his chairmanship, A.H. White tried to stimulate social activity amongst the departmental faculty. There was a little more togetherness in the faculty in the social sense when A.H. White was chairman.

There was less social life when Brown became chairman—maybe he thought it was a little bit too forced and therefore not friendly and spontaneous, or it may have reflected his own personal wishes. I can see several reasons for it. One was Brown's nature. The other was that it was wartime, and everybody was busier elsewhere as well as on the campus. The older faculty members were very receptive and helpful, and I spent many hours with Dick Schneidewind, and Dick Townsend, for example, especially on weekends when they seemed to be freer. What Brown enjoyed was a quiet evening at bridge with another couple; he and his wife Dorothy frequently played with the Monroes. Dave Monroe was on our faculty for a short time during and shortly after the war. He was an older person, perhaps retired from industry. He and Brown were very good friends, and Brown's social life was, I think, primarily small bridge events.

There wasn't much entertaining back and forth of new faculty in homes on any organized basis. There were friendships between faculty members. Bob and Betty White were quite friendly and they'd entertain in their home—again very small groups. There was one other social activity, which was only peripherally university. After the war, after the young people returned to Ann Arbor, some of them formed a group which was called the 100 Club, which was really a town-and-gown mix, a very happy group. They met once a month for dancing and sometimes a progressive dinner arranged for the group and that has many good memories because that is where we had the chance to become acquainted with the town people, many of whom are still here today. But before that time, my acquaintances were really all connected to the university.

Ann Arbor is much larger now. Most of the faculty lived in a small area, many of them within walking distance of the campus. Nowadays, Ann Arbor is so much bigger with more outside interests so there is less social interaction outside working hours. I notice there is now much more 8:00 to 5:00 than there used to be.

The department is still a lively place. All you have to do is try to find a parking place, but it is not quite the same as it was in East Engineering. That's just an indication that there are more cars. That there is life apart from school may show up in another way, and that is the longer residency for the doctoral students.

When Donald Katz became chairman, the only social life was centered around the graduate students. There was an informal picnic at the start of the fall term for the faculty and the graduate students and there was another and more formal event at Christmas, usually in Rackham, for the faculty and the student families.

Departmental Organization

When Donald Katz was chairman the department was well organized. There was a committee for graduate affairs, mostly counseling and advising in the graduate program, and committees to administer the doctoral preliminary and qualifying examinations. Faculty members were designated for certain tasks such as supervising financial affairs, the common laboratories, and the shop personnel. At that time we had anywhere from five to seven men working in the shop.

As mandated by the *Regents' By-laws*, the College of Engineering always had an executive committee, composed of the dean and four faculty members elected by the faculty. They serve for four-year staggered terms. There are other committees in the college, including the curriculum committee. In the department, one of Brown's introductions was the position of program advisor, appointed by the dean, customarily one for the undergraduate program and one for the graduate program in each department. The program advisor was responsible for all counseling procedures and for development of the programs or curriculums. I think that was somewhat opposed by department chairmen, when Brown first did it. But the chairmen very quickly found that the program advisor usually relieved them of chores that they were willing to relinquish. So the position of program advisor, 45 or 46 years later, still exists, typically being rotated among the faculty.

Every once in a while there was a major change in our curriculum, as for example when the new textbook *Transport Phenomena* came from the University of Wisconsin in 1960, which changed the general thoughts of teaching chemical engineering. The book combined all transport processes together as a unit more than we had done in the past. However, we did not and have not deserted the old unit operations, which were the backbone of chemical engineering, but rather it was a regrouping of those. For example, we introduced a separate and cohesive course in separations, and the transport processes then referred to all of the rate processes in chemical engineering—mass, heat, and momentum transfer.

I was the undergraduate program advisor for several years. We have sometimes shared the load over the years, but the program advisor, being the one who approves the student's completion of degree requirements, has the ultimate responsibility. But there are different styles, and Susan Montgomery, the present

advisor, has asked each one of the faculty individually to accept responsibility for advising a specific group of students.

3—PEOPLE AND EVENTS AFTER 1960

Giuseppe Parravano and Rasin Tek

Also mingled in that crew was Giuseppe Parravano, who was Italian. His doctorate degree was from the University of Rome, and he was a chemist particularly interested in catalysis. He taught at Notre Dame for several years and after leaving Notre Dame for a year, I think in industry, he came here in the late 1950s as a professor of chemical engineering and continued his interest in catalysis. He remained a chemist fundamentally rather than a chemical engineer, but was an interesting addition to our faculty. We lost him through his premature death through a heart attack.

Another one who came about the same time was Rasin Tek, who came here as a graduate student in mechanical engineering—sent here by the Turkish army to get his undergraduate degree. He was a native of Istanbul and his education was as an example of all that is best. He was tri-lingual, speaking French, English, and Turkish fluently. As a graduate student after his undergraduate degree he became associated or acquainted with J. Louis York. As a graduate student in mechanical engineering, he worked with York on a project involving fluid mechanics and the formation and breakup of drops and mists and their general behavior, all the time working for his graduate degree in mechanical engineering. He left here to work for Phillips Petroleum, where he stayed for four or five years working in the field of oil and gas production.

Rasin showed an interest in returning to the university one way or another. So, he came back as an assistant professor of chemical engineering, and because of his experience and work at Phillips, he was an ideal partner for Donald Katz. They complemented each other very nicely. Rasin was the new kind who was thoroughly familiar with computers, which were then in their infancy, and he was more mathematically inclined in his approach toward reservoir engineering and gas production so that he and Don Katz formed a good working partnership in research and consulting, which ended really with Rasin's departure from the university and Don Katz's death. That was an example of a wonderful partnership between a young and an experienced engineer.

Lawrence Van Vlack, Richard Balzhiser, and the Separation into Two Departments

Lawrence (“Larry”) Van Vlack came in the middle 1950s. He was neither really a metallurgical nor a chemical engineer. He had quite a background—including,

of all things, geology—but he also had an interest in ceramics and that type of material, so he was active in engineering materials. He wrote here the outstanding *Elements of Materials Science*, which was timely because that was when our engineering departments were beginning to recognize the need to introduce an overall course in materials, including everything from plastics and ceramics and metals. His textbooks were outstanding and were very widely adopted. They're still very much in use today.

Larry, who died in January 2000, was chairman for four years, from 1967 to 1971. Considering the breadth of the department, Dean Gordon Van Wylen thought that it was about time to find a leader from among the materials science and metallurgical group, and that person was Van Vlack.

After a year or so, Van Vlack proposed the restructuring of our department first into two divisions, and then into two departments, one Materials and Metallurgical Engineering (later renamed Materials Science and Engineering), and the other Chemical Engineering. The faculty discussed Larry's proposal at length, and it was finally approved and we went through the process of splitting into two separate departments. An intermediate step involved two divisions (not recognized by the regents), and Dick Balzhiser was appointed chairman of the Chemical Engineering Division and subsequently became chairman in 1971 for a very short time of the new Department of Chemical Engineering. The other part, the Materials Science and Engineering Department, still exists today.

Dick Balzhiser came here in the early 1950s, having been recruited as an athlete in the days when football was demanding, but not to the extent that it is today. Dick managed to make the first football team and he was a fullback during Fritz Crisler's and Bennie Oosterbaan's years. Those were the days when the coaches would permit a student an afternoon off for a required laboratory, which I don't think is too apt to happen today. So, Dick got his degree in chemical engineering. He was also on the All Big Ten Academic Team as a fullback. He stayed as a graduate student. After the first year, he became a teaching fellow and later an instructor, which was a rank used at that time for graduate students who were primarily involved in teaching while still working for their graduate degrees.

Dick got a master's degree in nuclear engineering in addition to the doctorate in chemical engineering, after which he became an assistant professor of chemical engineering. Throughout his stay in Ann Arbor he was interested in politics and was elected a member of the Ann Arbor City Council. President Lyndon Johnson developed the idea of White House Fellowships and Dick was one of the very first to be appointed as a White House Fellow. On a leave of absence from us, he served in the Department of Defense, first to Robert McNamara, and then to Clark Clifford. He returned to the U–M for a few years and left in 1971 to become assistant science advisor to Ed David during the Nixon administration.

Probably in 1973 or 1974 the Electric Power Research Institute (EPRI) was

formed by the American electric power industry, so the industry could combine in the sponsorship of large research efforts. Dick was one of the people approached to participate in the management and the formation of EPRI. Dick was hired as director of the fossil-fuel division, which included both nuclear and conventional coal, oil, and gas-fired power generation. Not only did Dick have a strong part in the founding and formation of EPRI, but on the retirement of his leader, Chauncey Starr, he became president of EPRI. He retired recently, but he's a good alumnus and still very much interested in the university, and visits us frequently.



Back row: Sharon Thatcher, Brymer Williams, George Huebner (director of research, Chrysler Corporation); front row: Jim and Mary Ann Wilkes, Gertrude ("Trudy") Huebner (U-M regent, 1966–1974). The Huebners were strong supporters of our department. Michigan League, April 1987.

The Staff

We were always ready to advise students who were really having trouble. Here, we found a tremendous amount of help from the well-informed secretaries, who maintained the student files and developed nice acquaintances with them. There are two or three of the program advisors I remember very well from the 1970s: Sharon Thatcher and Marge Lucas, both of whom were mothers and had raised children, were very understanding and quite approachable to the students. Anne Monterio was another one who was a natural counselor. The students are very

quick and adept at finding out who will listen to them! We couldn't have gotten along without these secretaries.

I don't think any of us claim to be professional counselors, but inevitably you get personal problems when you become acquainted with anyone. Students do become friends and share their personal problems as well as their academic problems. We tried to help whenever we could, and many of us have had the experience of a student coming back and saying, "Hey prof, you sure gave me good advice that time," leaving us wondering how many times we gave bad advice!

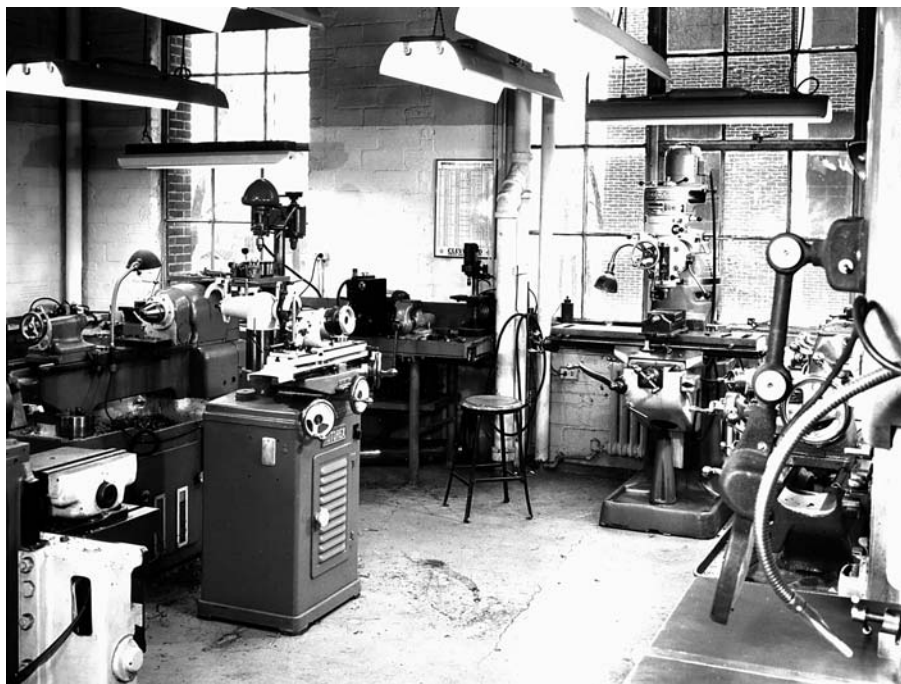

U-M Chem/Met graduate booklet, Dec. 1959

Department machine shop in the East Engineering Building.

We have had many notable staff members over the years—primarily the office staff and the shop crew. Thelma Dyer was a woman who worked, when I was a student, in the office of the Department of Engineering Research, later the Engineering Research Institute. When Brown became chairman, he appointed Mrs. Dyer as our office manager. The chemical engineering office staff then worked together in one large room—a “bull pen”—with three or four secretaries. Throughout the 1940s and the 1950s and into the 1960s, there were several young women who came to the department and eventually married graduate students. Those were the days in which the department was known as a happy place. We no longer have that same cluster of the bull pen, and there's more decentralization now. Mrs. Dyer had been raised at Annapolis, where her father was an employee of the Naval Academy. She married a graduate of the Naval Academy and eventually retired on

her husband's death and returned to live in Annapolis. She was the departmental secretary for both Brown and Katz and left roughly at the time Katz retired from the chairmanship.

Sharon Thatcher came to the university later, with three young children, the youngest then five, and worked in the program advisor's office and stayed with the department for 22 or 23 years, ultimately becoming the chairman's secretary and the development officer for the department. She was a very helpful woman, one of those who is a good counselor.



James Wilkes

Back row: Cleatis ("Fanny") Bolen (at his retirement dinner), John Wurster and Peter Severn; front row: Kathryn Wurster, Nettie Severn, Madeleine ("Madge") Ingerson, Novella Bolen. Michigan League, 28 April 1981.

In my student days there was a wonderful old-fashioned classical machinist who ran the departmental machine shop and the student shop. He had come through the old mining industry out west. He had one assistant. When I was a student and for many years thereafter, students were encouraged—because the shop people were also good teachers—to do their own work. I learned to run the lathes, the shapers and so on, under the watchful eye of, Mark Cunningham, the old-line machinist. Until late in the move to the North Campus we kept both the student shop and the departmental shop, and a full-time machinist, who was John Wurster in the later years. He was very good at teaching students and working out problems with them. I think that was an important element of the instruction for some undergraduate and many graduate students.

Then there was Cleatis Bolen, known universally as “Fanny,” who was everything. I don’t know what you might call him, possibly a millwright or something. He educated himself on many skills, which included those of an expert welder and a rigger. He and his colleagues were exceptionally versatile, and built excellent research equipment for the graduate students. They reconstructed, repaired, and moved our instructional laboratories.



Doug Connell, Erwin Muehlig, & John Wurster, 1970s. Courtesy Fay Muehlig.

Peter Severn came to us after he had worked for the Michigan Natural Resources Department, and immediately thereafter had run his own filling station at Lima Corners in western Washtenaw County. Seeing that his filling station would be wiped out by the construction of I-94, he looked elsewhere and came to the U-M essentially as an unskilled helper to the rest of the shop crew. Peter is a wonderful example of the opportunities that America presents to those who are possessed with imagination and desire. After several months as just an assistant pair of hands, Peter had looked around to see what we needed. He asked the shop-crew supervisor, Louis York, if he might experiment with learning glass blowing. His buddies in the shop immediately fixed him up with a corner in the shop area. They scrounged glass-blowing equipment, which in the beginning was rudimentary and inexpensive for Peter, and Lou York gave him the time and the raw glass and Peter went to work. He quickly became a skilled glass blower. He had the ability, the imagination, the steady hands, the eye and the persistence, and he became very good at designing and building scientific glassware.

Students found Peter to be an immense help because many of the pieces of apparatus—particularly glassware—do not exist for research purposes; you have to invent them and then find a way of building them, and Peter was superb in that and in working with the graduate students. I think many of them owe their successful dissertations to our shop crew, including Peter. Well, Peter eventually joined the Scientific Glass Blowers Association, became an officer in that, and that is an elite group—almost like a medieval guild in its exclusiveness. He still lives in the area and in retirement he has a little glass-blowing shop in his house. So his

inventiveness went far beyond the university.

Another one of the shop crew was Erwin Muehlig of the prominent Muehlig family of Ann Arbor. They had an old-fashioned hardware store downtown on Main Street and another branch of the family owned the funeral home, which still exists today. But Erwin worked in the family hardware store—Muehlig & Lamphear Hardware—and when that closed he was discovered, again by Lou York, and he came to manage our stock room, which again was an immense help to the students. Erwin was a member of Zion Lutheran Church and a U.S. army veteran of World War II. He died in 1978 at the age of 67, and his funeral was attended by a large contingent from the department. In our East Engineering Building stockroom, students could find what they needed rather than having to order from catalogs of the Plant Department. So, it's another instance in which the department supplied immediate and effective service both for our instructional and research laboratories. We had also an electrician, Elmer Darling, who came to us after retirement from the electrical industries, and did much of the electrical work around the department. This was interesting because we had to work closely with the U–M Plant Department, which is responsible for our own university buildings and equipment. In the 1970s, Doug Connell was our welder.

As one of “Brown’s Brats,” Lou York’s committee assignment starting in mid to late 1940s was to look after the senior laboratory and the shop crew, and he stayed as a friendly supervisor until he left for industry some 25 years later. That was just an example of the division of responsibilities in the department to relieve the chairman by delegating many of the responsibilities.

The Ford Foundation Computer Project

Virtually everybody in the department participated in the Ford Foundation Computer Project at some time between 1959 and 1963. The department was already involved in using computers in research. Cedomir Sliepceвич was possibly the first and Stu Churchill went along with him at the time when the university had no computers, and Sliepceвич did a lot of work with the old ENIAC located on the east coast quite effectively and knew what a difficult time that was. I used Michigan’s version—the MIDAC—on a research project. It was cumbersome, but an immense help. Then the university got in the business office the card programmed computer, the old IBM CPC, which we were invited to use and did. Stu Churchill was another who used it heavily throughout the 1950s.

Don Katz saw that the time was about ready for the use of computers in instruction so he talked with his friends in the Ford Foundation, principally Carl Borgmann, who had been on the faculties of chemical engineering at the Universities of Colorado and Nebraska and then went to the Ford Foundation as one of the senior people, and Don asked for a modest grant. He was thinking of something like \$25,000 or \$50,000, which we learned later was in the realm of petty cash

at the Ford Foundation and Carl Borgmann came to Ann Arbor, and met with Don Katz. He said he thought it was a wonderful idea, but however he thought it should be much larger than just Michigan and involve the entire United States. So Don did up the proposal request to something much larger, the ultimate amount being about \$900,000, which was a tremendous amount in those days. That was enough to start the Ford Foundation Project which, I think, had lasting effects.



Bob Kalmbach

G. Brymer Williams, 2098 Dow, 1984.

The Ford Foundation supplied a couple of computers to the project—the old Bendix G15 and probably helped buy the first IBM 650. I can't be sure of that, but we had right in East Engineering that early Bendix computer. Don assembled a staff. Elliott Organick had been one of our graduate students and was beginning to use the computer as a research person in the United Gas Corporation in Shreveport, Louisiana. Don brought Elliott back to supervise the project and then he gathered people like Elliott from other schools, Sylvio Navarro and Jack Famularo from New York City College, and some of our better graduate students and got them started with us. And then Don brought faculty from other universities here for two-week sessions and used younger alumni and graduate students who already had some experience in computing to teach those courses.

From that it just spread across the country, and Don, in his fashion, produced a few reports summarizing problems suitable for solving engineering problems by computer and distributed those as books. But the principal distribution—some dissemination of computing ability and use—was from the classes. The project paid the expenses of faculty from other schools, not just chemical engineering and

there were several distinguished visiting faculty, such as Hunter Rouse from Iowa State, who was then very well known in fluid mechanics. People came here, literally from coast-to-coast, to start computing. I remember having a conversation with Bernard Galler in front of the Art Museum talking about it, some time after the Ford Foundation Project, when computers had become much larger and faster and more accessible. I asked Bernie where was all this going? Were there any improvements possible still in the computing capabilities? Bernie replied, "Of course. They're only going to get bigger, faster, and cheaper." He was right about the last two!

In the early 1980s, when Jim Duderstadt was dean of our College of Engineering, came the second wave of the introduction of computers into engineering education with the establishment of CAEN, the Computer-Aided Engineering Network. This revolution spread to business first and then to the Lit School (Literature, Science, and the Arts). Since then, we have seen an enormous variety of machines, peripherals, and software available to all students.

Stuart Churchill

Stuart Churchill succeeded Don Katz as chairman in 1962 and served for five years. In contrast to A.H. White, Brown, and Katz, Stu was one of us, so the relationship between him and the faculty was quite different. He was an exceedingly bright teacher and innovator in the classroom, as well as a strong mathematician. Just before he became chairman, he instituted one of the major changes in the program—of introducing the proper use of mathematics in graduate instruction. It was overdue and Stu was the one who could do it. So, as chairman, Stu was the one that consolidated that advancement and it still exists today. Also, our department had an early proficiency in the use of computers even before the university had them, primarily because of Stu and his colleague Cedomir Sliepceovich. Stu also had the added responsibility of the presidency of the AIChE during the later part of his term as chairman, and that put quite a demand on his time. As chairman, he consolidated the major improvements that he had and others had introduced into our program.

In the cafeteria of the Michigan League there was a large table, holding as many as a dozen chairs, and several of us became accustomed to drifting over there. So you might say that we had daily faculty meetings at lunch at the Michigan League. The conversation was not necessarily about departmental affairs, but it was certainly a means by which the chairman could easily learn faculty opinions and attitudes about departmental matters. That was one pleasant informality which neither existed in the previous term nor after Stu left.

The BAM Strike and the Vietnam War

In the late 1960s, something happened at the university that people remember very clearly, and that was the BAM (Black Action Movement) strike, which lasted

for several days, and was directed towards increased minority enrollments. The Engineering College was in a unique position, and few of its classes were disrupted. As the strike started, Dean Van Wylen called the leaders of the BAM group into his office and explained what the Engineering College had been trying to do in the inner city of Detroit. It was very simple. The dean's office, counselors, and some of the department people had been trying for some time to get into the Detroit schools to encourage the enrollment and awareness of the university in the inner-city schools in Detroit. When Van Wylen explained all that to the leaders of the movement, and told them they were not helping our efforts to enroll more minority students, in effect they called off the strike against the Engineering College. There were some sad consequences. Many students were afraid to go to classes. One unfortunate element was that some of the people in the BAM bunch trashed the undergraduate library (where the engineering library was housed), walking through it and pulling all the books off the shelves. The engineering students volunteered and reshelfed all those books.

The faculty of the department accepted it as reasonable the settlement that President Fleming had made with the BAM group, to have a goal of 10% black. Although, when you set a numerical goal or quota there's always going to be some argument. I remember at the time Clifton Wharton, who was president of Michigan State (and also a black person himself), said that 10% was too high!

At that time, there was student protest not only against racism but against the Vietnam War. I always have in mind the New Yorker cartoon at the time of a student writing a letter home: "Dear Mommy and Daddy, we had fun today. We wrote naughty words on signs and walked around the City Hall." I think that was the attitude of some of them but for many of the students it was more complex. I'm sure that many students grew up quickly during that era. The students knew something was wrong about the Viet Nam War although they might not have known exactly what was wrong as a body, but certainly the leaders did.

Jim Wilkes, Brice Carnahan, and Jerome Schultz

When James Wilkes became the chairman, from 1971 to 1977, there were no further drastic changes taking place in the department. Jim brought a period of tranquility and consolidation to the department. Above all things, he was fair. I don't remember exactly when Jim and Brice Carnahan took over and developed the freshman computing course—Engineering 100 or whatever. It was really a course in engineering using computers, not a computer course per se. It was a course required of all freshmen and Jim and Brice did a superb job of developing that and changing it from year to year. They wrote new texts almost every year. That was a course in engineering and involved the experience of analyzing a problem, stating it in mathematical or other logical terms so that it could be solved by computers. Although the engineering analysis was the main theme, the students

somewhat incidentally became quite skilled in the use of computers. The early 1970s was also the period in which hand calculators became available and we argued as to whether a student who could afford a calculator (the good ones cost about \$400) should have the advantage of being able to use it in examinations. But in a very short time all the students appeared with hand calculators, which wiped out the nice old slide rule. But Brice and Jim, in their own way, tested the use of hand calculators. They devised a chemical engineering examination in which the numbers were so simple that all multiplication and division could be accomplished mentally. You didn't even need a slide rule! The students were told they could either use their calculators or not, and, with that exam, students with the calculators did better, which showed that the advantage was extreme—emotional or something, not mechanical.

Jerome Schultz was the first chairman whose research interests were biomedical. Since the late 1940s or early 1950s, we'd had Lloyd Kempe on the faculty. Lloyd was a microbiologist as well as a chemical engineer, and he had introduced courses mostly related to the food and pharmaceutical industries. Thus, we'd had the thread of microbiology running through our department for almost 25 years—one of the first in the U.S. to do so. Jerry Schultz expanded that to include the medical sciences, which had been strong in his background. So his chairmanship was the expansion of that application of one part of the life sciences into medical engineering and that has since become very strong.

Scott Fogler, Johannes Schwank, and Ralph Yang

Scott Fogler is one of the most energetic and productive individuals that anybody could find anywhere. By accepting the chairmanship, there was probably considerable sacrifice of his own personal work because he has been writing his textbook on chemical reactor design. This is one of the outstanding books in the field, very widely adopted worldwide in chemical engineering programs. That book was a new, imaginative, innovative effort, and Scott has also been giving, still does, quite a lot of thought on innovation and analysis. He is responsible for the systematic introduction of open-ended problems, that is, problems in design or otherwise that have no single specific solution, problems in which the final decisions involve human judgment to resolve intangibles rather than anything numerical—intangibles such as human behavior, environmental conditions, or political considerations. Scott has compiled and has published a book, in which unforeseen considerations have caused either a disaster or a humorous mistake. Engineering mistakes are a very useful way of teaching and learning. Some of them are tragic, leading to the loss of property and lives, many of them because of something we didn't think about, such as extreme external conditions, weather, natural disasters, or human stupidity. Some of them are grisly; some of them are funny.

Johannes Schwank thought quite a bit about the future of chemical engineer-

ing and the direction that the department should be taking because the use or market for chemical engineers is changing and chemical engineering has always been responsive to external changes. We've always had trouble defining chemical engineering. G.G. Brown, in a famous editorial of his, defined chemical engineering as whatever activity chemical engineering education qualifies a person for, which means chemical engineering is whatever a chemical engineer does. Johannes gave a lot of thought to the response of chemical engineering education to the changing world outside. During his tenure, the dean of the college made much more use of an external advisory committee of prominent people from industry and government and research. Johannes was an intellectual, responsive leader.



Paul Jaronski

Jan and Scott Fogler, October 2000.

Ralph Yang came to us from the State University of New York at Buffalo, an acknowledged leader in research in his field, and I'm sure he is another one who has accepted the responsibilities of chairmanship to some disadvantage to his own personal career. A person just simply can't maintain his full research load and effort and be chairman. Chairmanship is fairly demanding.

Chapter 22

WHEREIN OUR ALUMNI HAVE THE LAST WORD

DURING the preparation of this book, and again at the 1998 Centennial, we invited our alumni to send us reminiscences of their days at Michigan. The following contributions were received.

SENT BY ALUMNI

James Ryan (B.S.E. 1954, M.S.E. 1955, Sc.D. (MIT) 1958). I was a sophomore chemical engineering student in the 1951–1952 school year. Tom Slykhouse was also a chemical engineering student and a friend. Tom asked me if I would be interested in doing some engineering work and making a little money. I liked the idea. I was hired onto the ERI (Engineering Research Institute) project of Prof. York, Gene Stubbs, Rasin Tek, Herb Canfield and Tom Slykhouse, which was studying sprays for DeVilbiss. There were a couple of rooms in the East Engineering Building, one for an office and one for equipment, including a down-draft spray booth.



and multiplied for the next digit in the multiplier. Wow! State of the art(?).

We did all kinds of things, including measuring and counting zillions of droplets in photographs of sprays and having to reconcile the numbers and diameters with the known flow rate to the nozzle. Tedious! To help in the calculations, the department generously provided a Marchant mechanical calculator that we could use, located in a room in the north part of the building. The calculator was bolted to a frame stand and a chain similar to what would be used on a child's swing chained the frame to the heating pipe. Security! To multiply, we entered the multiplicand and held the operate button down and the motor added the multiplicand time and time again until we saw the desired digit on the display. Then we moved the carriage over one column (factor of ten)

I recollect that I started at 15 or 20 cents/hour. Over the next year or two, I received raises and that pleased me. The most exciting raise was when I went to 60 cents/hour. I was astounded that I could make a penny each and every minute that I worked. Those were the good old days!

I recall the *Petroleum Engineering* course with Prof. Katz. One of the tools Don handed out to each student was a copy of the *Natural Gas Supplyman's Engineering Data Book*. That “book” had been printed on 8.5×11 -inch paper, stapled and folded. The current successor is the Gas Processor Association's *Engineering Data Book*, two volumes in 1.5-inch three-ring binders with 26 sections and about 900 pages. That is progress!

Prof. Katz had a special teaching style. He encouraged us to be inquisitive on the job. For example, while spending long hours and days in the gas field, he cajoled the geologists into telling him about petroleum geology, and he became a pretty good oil and gas geology expert. Never a dull moment in that class. For someone like me who eventually specialized in distillation, Don's explanation about multicomponent distillation was like a ray of light on a dark stormy day. He made an indelible impression. I'm sure many of us have clear, vivid memories of his classes and vital lessons learned from him.

Those years from 1950 through 1955 were very exciting times. I love to remember them. The Chemical Engineering Department was great fun and inspiration to this young engineering student.

I have had a career-long fascination with industrial separations, including distillation, membrane separation, and large-scale chromatographic column separation. My introduction to counter-current multi-stage vapor-liquid contacting was from Don Katz in the 1950s. Right on! I have just started Ryan Consulting, Inc, with a specialization in fractionation and simulation. I have recently retired from 35 years with Koch Industries. I was their first and only engineering fellow.

William M. Saltman (B.S.E. 1938, B.S.E. (Engineering Mathematics) 1938, M.S.E. 1939). I enrolled as a chemical engineer at Michigan in 1934, coming from Perth Amboy High School in New Jersey. I had no trouble getting into the several schools I applied for since I had won both the chemistry and mathematics prizes in high school. However, Carnegie Tech wanted me to take German, MIT was too expensive, and Cal Tech was too far away. When the editor of *Chemical Engineering* told me that Michigan had as good a department as MIT, I chose the U-M because it was closer, cheaper, and didn't require German.

My first two years at Michigan were uneventful and on the whole free of any meaningful contact with faculty. I took the usual courses and my grades averaged about 3.2 (B+). I worked (under the National Youth Administration Program) in the chemical engineering unit operations laboratory for a graduate student named Peavy, who was studying the effects of varying weir heights in bubble-cap distillation columns. I spent lots of time cleaning rust off pipes, using a

chain hoist, and replacing and caulking weirs for him. It was my first “engineering” type of experience and I learned lots.

In my junior year I took unit operations from Profs. Donald Katz and G.G. Brown and was impressed by both their knowledge and their loud voices. Dr. Katz gave me a lead to a summer job with Carter Oil Co. (a drilling subsidiary of Standard Oil of New Jersey) in Tulsa. Because I wear glasses they would not allow me to work in the oil field, I spent part of the summer analyzing drilling cores for porosity and oil content, and part of the time in the office calculating optimum well spacing as a function of cost and interest rates, etc.

During my senior year Prof. Alfred H. White, who was then chairman of the department, called me into his office and suggested that because I was Jewish I might be happier transferring to the Chemistry Department rather than staying in chemical engineering. At that time I was quite sure that he was motivated by anti-semitism, which was almost universal in industry before World War II. From my viewpoint today, I am not so sure. Perhaps he did have my best interests in mind, but I could have benefited from such “counseling” a few years earlier.

At any rate I finished the year as a chemical engineer. As part of the senior year course in 1938, everyone had to do a research project. I did mine with Prof. Donald Katz, measuring the surface tension of ethane, propane, and butane at several temperatures. I did this in a heavy-walled steam gauge with a capillary tube and assorted other stuff. Dr. Katz helped me to find a transparent glass window so I could read the height of the capillary.

So I did my work, wrote it up, and turned it in. The following January, I found that Dr. Katz had taken my data, extended it (in theory), and made in into a paper worthy of publication. It appeared in *Ind. Eng. Chem., Anal. Ed.* in 1939. He put my name on it along with his own and made me very proud. It was my first publication and turned my interest towards research so that later I was able to go back to school after World War II and get my Ph.D.

I got a B.S.E. in chemical engineering and one in engineering mathematics in 1938; I couldn't find a job and returned to get an M.S.E. in 1939. I took *Thermodynamics* from G.G. Brown, *Refinery Engineering* from Katz, *Unit Processes* from Brier, and something else from Pettyjohn.

I worked in the federal civil service as a materials engineer, joined the army, and after my discharge used the G.I. Bill to get a Ph.D. in chemistry from the University of Chicago—not because of A.H. White's misbegotten advice but because chemistry satisfied my wish for a more fundamental and theoretical knowledge of nature. Engineers seemed to rely too much on empiricism and following handbook practices.

In subsequent years I found there were some engineers with broader backgrounds than I had encountered in my undergraduate years. I found it easy to work with them because I could appreciate their engineering concerns more than

a chemist with only laboratory experience.

Keith H. Coats (B.S.E. 1956, M.S.E. 1957, Ph.D. 1959). My father, Hal B. Coats (1903–1996), earned B.S. (1925) and Ph.D. (1929) degrees in chemical engineering from the U–M. I also received three degrees from the U–M. The two men perhaps most admired by my father were Prof. Eugene Leslie and his doctoral advisee, Professor (and later dean) G.G. Brown. I visited “Doc” Leslie, with and without my father, at numerous times throughout the 1950s at his home and laboratory in Ann Arbor. After his Ph.D., my father worked for Leslie at his Ann Arbor laboratory during the Depression.

In my student years of the 1950s I was impressed by the quality of the department’s teaching staff. However, it was only later that I realized how truly outstanding they were, each in different ways. Two in particular showed their dedication in meticulously prepared notes and presentation, so logically and well organized that learning was almost easy. In a few years of teaching at Michigan and Texas, I tried to emulate, but never equaled, that teaching style of Joe Martin and Jim Wilkes. Brymer Williams had an exceptional personal teaching style that made us think for ourselves. I recall his first answer to many of my questions was “What would you say if I asked you the same question?”. His sequel, when I failed, was discussion leading to the answer. I have difficulty finding words to describe the standards of professional effort, excellence, and integrity set by Prof. Donald Katz. There were many other excellent staff members.

Robert Warden (M.S. 1950). I came to Michigan as a graduate student in 1949. I received my B.S. degree in chemical engineering from Purdue University, and thought it would be wise to do graduate work at another school.

At this time I was still on the G.I. Bill, but could use some extra money, so my wife got a job as secretary to the principal of the University High School in Ann Arbor. To supplement our income further, I applied for work in the Chemical Engineering Department. The head of the department, George Granger Brown, not knowing me from Adam, offered me a job teaching undergraduate chemical engineering thermodynamics. He was a great guy to work for, and I will not forget what he taught me and the guidance he gave me.

This department job was also very helpful since at the same time I was taking graduate chemical engineering thermodynamics under a great person I will never forget—C.M. (“Cheddy”) Sliepcevich. Those of you who are familiar with people in this time period can appreciate my position; it was unique and I learned a lot.

I had other very fine professors, D.L. Katz, Joe Martin, Bob White, Brymer Williams, and many more. I will always be grateful for the attention and assistance these people gave to “a stranger from Purdue.”

Carl J. Pinamont (M.S.E. 1948). As a World War II Navy veteran and B.S. graduate of the University of Colorado, I was very impressed by the empathy of

the department for the concerns of veterans. We recognized the huge demands posed by the quantum leap in candidates seeking advanced degrees.



Betty and Carl Pinamont at their wedding in Boulder, Colorado, 17 April 1948.

I was accepted for the M.S.E. program starting in fall 1946 and completed residence requirements in June 1947. My advisor, Prof. R.R. White, approved the transfer of six credit hours obtained at the University of Colorado. My future wife resided in Boulder. The wedding was in April 1948, and we celebrated our 50th in 1998. The U–M granted me the M.S.E. degree on 12 June 1948. Dr. White certainly went the extra mile to accommodate my desires for these two important events.

Two of my associates in Ann Arbor were Jim Knudsen and John McKetta. I lived in the same dorm as Jim Knudsen at Willow Run Village in Ypsilanti. We commuted to Ann Arbor by bus. Jim served as dean at Oregon State University later in his career.

I revisited the U–M while employed at the Dow Chemical Company in Midland. The company and the university jointly sponsored a modern engineering course in 1969 and 1970. We senior engineers learned something of the direction of engineering education. Prof. Bob Kadlec directed the program.

My experiences at the U–M were memorable and worthwhile.

George F. Paulus (B.S.E. 1951, M.S.E (protective coatings) 1953). Following military service in World War II and a brief period of employment to obtain additional funds, I was a student in the College of Engineering from 1947–1951 and from 1952–1953. The training I received through the Department of Chemical and Metallurgical Engineering proved to be excellent preparation for a very satis-

fying career in the polymer and protective coatings industries. I have always been grateful that the department's faculty placed teaching foremost and made an extra effort to insure that the student understood the content of the courses required for the coveted degree. This was accomplished by superior class preparation, review sessions outside of regular classes, and friendly discussion over a cup of coffee after class. My comments apply both to the bright young staff recruited by Prof. George Granger Brown and the veteran department members. All placed education of the student first, although many were brilliant researchers.

I also recall the non-technical part of the curriculum, particularly the strong English program, and basic economics and fundamentals of accounting. I found the latter very useful in the administration of a research and development department consisting of 25 professionals and technicians.

Paradoxically, upon retirement, I no longer use my technical training. However, I find myself a board member and treasurer of the local Red Cross chapter, where I am involved in the budgets, purchasing, and financial planning. The education received through the U–M department has thus brought lifetime benefits.

What else can one expect of an education received from the best university, the best college, and the best department?

I also met, courted, and married a nurse from University Hospital and together raised a family of ten children!

Doug Greenwold (B.S.E. 1965, M.S.E. 1967, M.B.A. 1969). The education in systematic thinking received in the chemical engineering curriculum has proved invaluable in 25 years of business. Understanding independent and dependent variables in a system interface and integration context has proven itself time and again in market analysis, strategic marketing, and planning. I couldn't think of a better systematic grounding for business success than that provided by my U–M chemical engineering education. Thank you, ChE!

Ronald N. Grabois (B.S.E. 1964). I am living in Houston. Now I am a sales manager for a small company that is currently trying to stay alive and grow. This was after 23 years with Conoco. I “elected” to retire early in 1996. Quite a change to a small company. I really enjoyed it. We have brought hydrocyclone technology to the dry-cleaning industry. They are amazed. I do get up to the Ann Arbor area about once a year. Usually it is to see my daughter, who lives and works in Detroit.

I have talked to Jim Street a few times since I have been here. As they say, he has done quite well. I am willing to do recruiting or whatever the department needs down here. I have volunteered to do some things and occasionally I get called upon. Good luck in the future. I will continue my financial support as long as I can.

Now, if we can get a better offensive coordinator!

James O. Wilkes (M.S.E. 1956, Ph.D. 1963). I am always fascinated at meeting people whom I can call real “characters,” and in that vein I recall two such in the College of Engineering—Anne Monterio and “A.D.” Moore. I am happy to call both of them honorary chemical engineers.



Bill Wood

Anne Monterio had an illustrious career in the College of Engineering, but she was first employed as a secretary in the Chemical Engineering Department, in 1974. Unfortunately for us, but fortunately for her, her talents—particularly at working with people and encouraging students—were soon recognized by the college administration, and in 1975 she moved over the road, to West Engineering. She rose quickly† through several student service positions, including administrator of Interdisciplinary Programs, director of the Minority Engineering Program Office, director of Academic Services, and assistant dean for students. Anne is consistently warm-hearted and a great encouragement to all that know her. A retirement reception was

held for her in September 2000.



James Wilkes

Arthur Moore, “A.D.” to everybody, was a faculty member in the Electrical Engineering Department, but frequently visited Jim Wilkes for a chat on technical matters. He was proud of the fact that he was born in the same year (1895) that the electron was discovered. His main interest was in a very important but somewhat neglected area—electrostatics, and he was the first president of the Electrostatics Society of America. He earned his B.S.E.E. at Carnegie Tech in 1915 and started his nearly 50-year teaching career at the U–M in 1917, receiving his M.S.E.E. from Michigan in 1922. For many years, “A.D.” presented an informative and humorous lecture/demonstration in electrostatics, which he took all over the country in his car. He

usually started by placing a \$50 bill on a piece of equipment and invited anybody in the audience to come and take it, saying “I should caution you first that there are 40,000 volts across those electrodes.” “A.D.” served 17 years on the Ann Arbor City Council, and died when he was almost 95.

† I am indebted for some of this information to the *Michigan Engineer*, fall/winter 2000.

John David Marks (B.S.E. 1950, M.S.E. 1951). To offer some short pieces of nostalgia:

- When at the grad student picnic in 1950, Chairman G(reat) G(od) Brown wasn't present, but his colleague J.C. Brier relayed his regrets and said "But I'm J.C., and you know who that is!"
- When C.M. Sliepceвич bet a student double or nothing on his grade (of 50, when the rest of us were lucky to get a 17); then kept him waiting for weeks on an obscure bit of data. When the blue book was finally returned, the student lost—a giant **ZERO** for all the class to read, but in the tiniest letters: "Sporting blood—final grade 50."
- When Brymer Williams gave us a homework problem equivalent to filtering the Mississippi river. My room mate Don Kory spent the evening converting all units to the obscure and/or obsolete and dropped it along with a copy of my solution on Brymer's desk. I only remember rubles per square nail for the cost of filter screen. Next exam, Brymer passed it out and then waited a L-O-N-G five minutes before giving us the real exam. One student worked both!
- When our dorm mate Hans Heilbronner, who just retired as professor of history from the University of New Hampshire, trundled all the way up to the big hole press on the fourth floor of the Engineering Building and punched holes on the *right* (that is, the "*wrong*") side of his *painstakingly* typed 100+ page bibliography for his thesis. (Remember, there were no PCs in those days, but at least we had typewriters.) Neither his words, nor ours, will be repeated here.
- And, when mine were the *only* pair of cowboy boots on campus.
- My wife, Jeanie, who saved me from the dorms by marrying me, joins in wishing you all continued success. Y'all keep up the good work!!!

Daniel J. Sajkowski (B.S.E. 1981, M.S.E. 1982, Ph.D. (Stanford University) 1986). There is no doubt that one of the best experiences I have had was my education at the University of Michigan. I can still vividly recall my chemical engineering classes. I have nothing but the highest regard for the faculty, due to their emphasis and interest in teaching. My experience included undergraduate research with Prof. Donahue, and led to my first publication. I did a master's thesis with Prof. Schwank, and his enthusiasm was contagious. I also recall the tremendous lectures of Prof. Fogler and the exacting approach of Prof. Curl. Each of these professors, along with many others on the faculty at that time, set high standards that have helped me throughout my career. Thanks!

Ernest K. Tanzer (B.S.E. 1938). Throughout my career, doing engineering design work, production supervision, and administration of environmental control programs, I found the basic training I received at Michigan to be essential and extremely valuable. The training in unit operations, physical and organic chemistry,

and thermodynamics, was of endless use. The faculty were forever memorable and inspirational, particularly Professors Love (mathematics), G.G. Brown, A.H. White, D.L. Katz, and Stout (electrical). Whenever I get together with classmates at reunions and visits, we always reminisce with stories of class and campus events, often humorous, and always with pride.

The years at Michigan were delightful and, of course, memorable. The students certainly exemplified class, particularly my engineering classmates, many of whom continued to have outstanding careers, benefiting not only themselves but others.

Marty Javinsky (M.S.E. 1965, M.S.E. Information & Control Engineering 1966, Ph.D. 1967). Here some of my main memories of graduate school from 1963 to 1967:

- Having to build something to earn a Ph.D. No “paper” thesis allowed. Designing and constructing a complete CSTR system gave me some valuable hands-on skills with tools and equipment . . . skills that I might never have acquired elsewhere. On the first day I proudly demonstrated full operation to Bob Kadlec, chairman of my doctoral committee, a pressure surge in Ann Arbor’s water system entered the cooling jacket of the CSTR, crushing the reactor wall and setting my project back two months. So, I also gained practical experience with surge-control systems and wall-thickness calculations.
- Administrative flexibility, which enable me to merge a process and systems focus through degree programs and a thesis sponsored jointly by faculty in the Chemical Engineering and Information & Control Engineering Departments. This process/systems background served me well not only in the technically oriented part of my career, but also in my subsequent career in management . . . which today views all work as a collection of processes amenable to systems-based improvement.
- Inspirational guidance from Bob Kadlec during my graduate-school years . . . and also from Brymer Williams, who showed up at the final oral examination on my dissertation—even though he was not a member of my doctoral committee.
- Furthermore, Bob and Brymer persuaded me to join Chevron, even though my first choice was a major chemical company. They accompanied me on a visit to the latter, noticed that nobody in management smiled the whole day we were there, and convinced me that Chevron would offer an equally challenging but friendlier environment. I guess their recommendation worked out—I’m still happy about the choice in my 29th year at Chevron (as of 1995).
- Associations with fellow students Mark Newberger, Finis Carleton, George Quarderer, Charles Guffey, Vic Yesavage, and many other terrific people.
- Commitment, accessibility, and camaraderie provided by the faculty.
- Great times at the Pretzel Bell, Bimbo’s, and watching the tradition of excellence in sports grow through such figures as Bob Timberlake, Cazzie Russell,

Bill Buntin, and Oliver Darden.

- Finally, in our 32nd year of marriage, Cookie and I can say that the graduate-school environment must have helped to create a solid foundation for our future.

David B. Harwood (B.S.E. 1983). Here are my general comments and recollections:

- ChE 230 and 330 with Prof. Curl rank as two of the toughest, eye-opening challenges of my life. Although I have been confronted with many more difficult tasks since then, these were undoubtedly the hardest things I had done until that time.
- Trying to maintain my dedication to school work while being a member of the Marching Band and a social fraternity was not easy. Although I took lighter class loads each fall, the resulting heavier load in the winter was difficult, at best.
- Of all the ChE courses, I have the fondest memories of ChE design. Finally, we got to apply what we had learned. I'll never forget the first day of design class. Prof. Young walked in and, without a word, began writing numbers on the board . . . 230, 330, 341, 342, 360, etc. He turned to us and said "If you expect to succeed in this course, you'll need a working knowledge of everything presented in those!"

FROM THE CENTENNIAL†

Sam Dreisbach (B.S.E. 1949, M.S. (Chemistry) 1951) recalled that "the research atmosphere was always what influenced me. I worked from practically the first day I came here. Then I went into the service, and returned and completed two B.S.E. degrees, in chemical and metallurgical engineering. Then I transferred into chemistry and got a master's degree in electrochemistry. I had to work to go to school, and that influenced me. I've been in research all my life."

From 1952 to 1959, Dreisbach worked for the Kaiser Aluminum Chemical Company, studying the production of aluminum for fused salt chemistry research. Then he worked for the Federal Mogul Corporation, doing research on the plating of sleeve bearings, washers, bushings, and pistons. Upon retirement, he started his own consulting company, DAS Consulting. Looking back on his career, he explained that "I started in engineering and went into research, and I've been on the frontiers of research ever since."

Farrand Parker (B.S.E. 1936), maker of the Badger Trophy, and his wife **Barbara Parker**, remembered how that award came into existence. "All the

† During our Centennial in May 1998, attendees had the opportunity to reminisce about the department. Their comments were recorded and edited by Dr. Suzanne Burr.

graduate students had to get to work. After all, this was 1936 or 1937, in the depths of the Depression. Everything was done in the chemical engineering laboratory. We did our own work—such as plumbing, fabrication of equipment, and so forth. Some things that came out were bizarre. Atrocious and astounding, they defied comprehension. For example, piping support is supposed to run rectilinear. But ours didn't! It had valves, nipples, etc., done by amateurs—no unions or anything! Hardware was the name of the game. Even Dali couldn't have conjured up these things!

I thought the situation was so creative and bizarre, that it deserved an award each year for the most astounding or revolting invention. So, one after, I put some flanges on a base plate, added some piping, and made the first 'Badger Trophy.' This was in honor of Walter Badger, the grand old man of chemical engineering. Frankly, he scared off most of us with his gruff manner and his comments such as 'You'd be better off running a hardware store.' the Badger Trophy showed that there's a point where engineering leaves off and common sense takes over, and that's when it's down to 1/4 inch."

Ken Robinson (B.S.E 1963, M.S.E. 1964, Ph.D. 1967) enjoyed the Centennial events and looked back fondly on his U–M days. "I did the entire Vietnam War," he said of his years at the university. "I had wonderful teachers, such as Jim Wilkes, Brice Carnahan, Brymer Williams, and Dale Briggs."

Robinson recalled making things out of the copious raw materials that lay at hand during those days. "I remember when my wife and I were expecting our first child. I wanted a baby cradle but couldn't afford one. So I scouted around the East Engineering Building and found some lumber not being used, from which I carved and constructed the cradle."

He also remembered the encouragement that came from a faculty member at a time when he really needed it. "There was a yellow letter sent around at that time that basically said 'You are gone.' One day I got the dreaded letter in the mail. I thought I was finished in the program. In a panic, I took it to Prof. J. Louis York. He looked at it for a few moments, then said 'Why don't you ignore this? I hear you're a good student—you'll do fine.' Well, I stayed in the program. And I never forgot what he did."

Brice Carnahan (Ph.D. 1965), currently a faculty member of the U–M Chemical Engineering Department, greatly enjoyed the Centennial Celebrations. "It was wonderful meeting people, especially students I hadn't seen in years—such as Clifton Goddin, an 'oil man,' who was somewhat older than the rest of us when he got his Ph.D."

Prof. Carnahan remembers the graduate-student picnics as "politically incorrect" but a lot of fun. And he remembers the awards, such as the J. Louis York Award (a huge cylinder of polymerized styrene) for the student who took the

longest to earn his or her Ph.D.—in honor of the professor who had taken ten years in pursuit of his doctorate. And he recalled the Poohbah of the Piled Papers Award, for the messiest office. “Either Jack Powers or Joe Martin always won it,” said Carnahan.

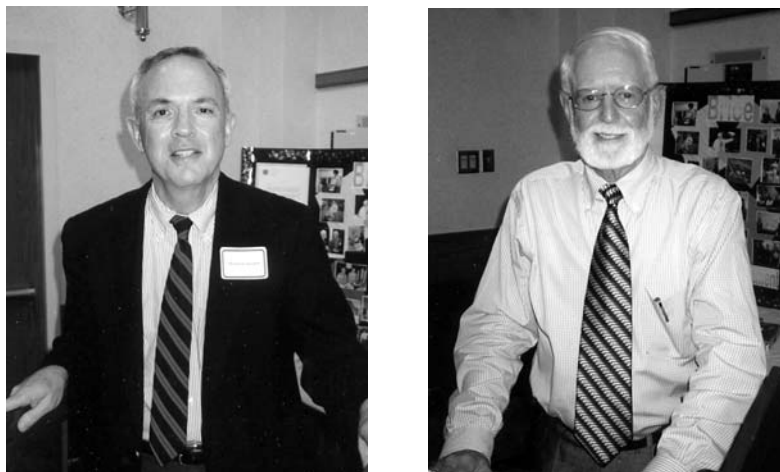

Warren Seider (L), Brice Carnahan, at Brice's retirement, 8 Sept. 2001.

Warren Seider (Ph.D. 1966) remembered the great teachers he had in the department and how they made learning interesting and efficient. “I was here in 1963, and later in the 1970s. I studied with Jim Wilkes and Brice Carnahan, taking their numerical methods course. I remember especially how they prepared class notes. They set up ditto masters and ran off the notes just before the lecture, so the students would have the topics. This was a very effective mode of communication, because you couldn't put all the analysis on the blackboard. In the end, all the notes were assembled and published as *Applied Numerical Methods*, which became a best-seller for John Wiley. It also had a major impact on my career. I started my work with Stuart Churchill, investigating jet mixing. I began to use the numerical methods to simulate the mixing, to understand the process better. At that time, there was a single computer for the whole university—the IBM 7090. You used to have to punch the data and program onto cards, walk over to the Computing Center, give them the cards, and a *day* later you'd get the results!

I also worked with Don Katz and Brice Carnahan. They obtained funding for a project through the National Science Foundation, on computers and design education. They invited 40 professors from five faculties of engineering to visit the U–M for 16 weeks during the summer of 1965. I volunteered to be the graduate assistant, and—fortunately for me—they accepted me. We learned much about how to teach design with the computer, and we wrote an extensive series of reports—about a thousand pages altogether—on how to use the computer in teaching design, which we finished in the fall of 1965.”

From this experience, Seider also found his life's calling. "Then Katz and Carnahan got another \$200,000 to travel around the United States to seven different locations. At each location, two professors from each engineering school were invited to attend. In the fall of 1966 they took me along, and we spoke to 600 professors. That's how I got into teaching, and it was a great experience.

Then the first interactive computers were developed. The GE 235 timesharing computer was invented and a language—BASIC—was developed for it. Well, this marvel permitted you to sit at a teletypewriter terminal, and you could call the telephone number of the computer, which responded with a beep and said hello! So, we taught all these professors how to do engineering design interactively. At long last, we could put the decks of cards aside!

I became really involved in teaching with the computer, and I decided to be a professor. I've been teaching for over 30 years, at the University of Pennsylvania, mainly teaching computer-aided design. My inspirations here at U-M were Brice and Jim's tremendous enthusiasm for the computer, and the opportunity to work with Don Katz."

Fred Shippey (M.S.E. 1970) credits his training at the U-M with developing his strong problem-solving skills and entrepreneurship. "The real secret of engineering, and chemical engineering in particular, is the unit operations model," he explained. "Learning different processes, you can put them together to solve problems." Shippey put these skills to good use at Kodak for 22 years, working on electronic imaging. Now he is a consultant and writer, specializing in translating technical jargon into understandable English—"short and sweet language," as he put it.

Shippey spoke of the U-M as the training ground for learning effective methods and approaches for solving problems. "A program like this gives you great problem-solving skills," he said. "What with the half-life of technology, you have always to expect to solve new problems. One of the real strengths of chemical engineering is that you can solve so many different kinds of problems—mathematics, physics, and so forth. Other fields are more narrow in focus. To me, the new model in engineering is that you have to be more of an entrepreneur. The paradigm has shifted. Now, you have to take responsibility early on for your own retirement. We need to encourage kids to do more on the business side. The 'carrot' of the 1990s was stock options. The reality is that small companies can be more innovative."

In his daily life, Shippey is a multi-faceted innovator who "wears many hats." As a Penfield School District school-board member, he works to explore better ways of teaching analytical and problem-solving skills. "The expert model is a good one for high-school students," he explained. "The students are presented with a problem, and we help them how to discern good knowledge from bad." He also works on the Board of Cooperative Educational Services, applying his teaching and mentoring skills to the young generation. "Forty years ago we started special

education to help the young,” he recounted. He remembered U–M’s faculty as an inspiration along his path. “There are really great teachers here. Brymer Williams was one—they used to call him ‘the students’ friend,’ and he really was. Brymer really made an effort to help students and took a great interest in them. Students always felt he was someone they could talk to.”

Another influence Shippey remembers was Earl Britton, who taught in both the engineering and the English programs. “He really influenced me. Communication skills are so important, both in engineering and in life.”

Rasin Tek (B.S.E. 1948, M.S.E. 1949, Ph.D. 1953), an emeritus professor, and his wife **Gretchen Tek** now live in Hawaii and flew in for the Centennial. They had a wonderful time, and Rasin recounted an anecdote of his student days here. “Dick Ahlbeck” and I were in the same year, and we both took Great God Brown’s lecture. One day, Brown asked a question, then looked in our direction and said ‘You there, yes you, the good looking guy.’ Well, both Dick and I started to answer. Then Brown waved his hand at Ahlbeck and said ‘no, not you, *him*.’ I never lived that down, and Dick never forgave me either!”

Gretchen’s father was Karl Henry Hachmuth, U–M chemical engineering class of 1925, who had a distinguished career at Phillips Petroleum Company in Bartlesville, Oklahoma. Neal Amundson, then at the University of Minnesota, rightly described him as one of the most respected chemical engineers in the country. Karl Hachmuth was married to the former Margaret Gretchen Johnson, who also earned her bachelor’s degree at the U–M, in chemistry in 1924.

Peter Lederman (B.S.E. 1953, M.S.E. 1957, Ph.D. 1961) and his wife **Susan Lederman** remembered the family feeling that existed among the department members during their years here. “The department was very close in the late 1950s and early 1960s. One tradition that kept everyone together was that the department members sat together at football games, and there were also potluck dinners at people’s houses. The faculty and graduate students really got to know each other outside of the classroom, and that made it a very human experience.

Brymer Williams was particularly loved for all that he did for students, and was a great role model. He always said ‘do what you want.’ He invariably helped students in need, usually without anybody being aware of it. He is remembered with great fondness by alumni, who invariably seek him out when they return to Ann Arbor.

I recall how Brymer was under the gun to complete the department’s budget when he was filling in for Professor Katz as acting chairman during 1956–1957. Brymer asked me to deliver a lecture for him in Kingsville, Texas the next day. I told him, ‘Brymer, you don’t understand. Tomorrow is my girlfriend’s birthday, and I was planning on getting engaged. The cake’s ordered, the ring’s bought . . . please, just this once.’ Well, Brymer was in a fix, and I had to go. But he really

did care about my situation. The next day he and another faculty member picked up the cake and rang the doorbell of the Sigma Tau Delta House and politely asked for my girlfriend. She came to the door, and they handed the cake to her and sang ‘Happy Birthday’—as if it were the most natural thing in the world for two senior faculty members to deliver birthday greetings personally to a student!”

Anna Waller and Cattaleeya Pattamaprom, both chemical engineering graduate students, really enjoyed the day’s activities and learning about the department’s past and the richness of its continuity. They also noted how much some things have changed for the better. “For women, things have changed a lot. As a group, we have our own society and support groups. We meet for coffee and get-togethers, and it’s so good to have somebody to talk to about problems. The women faculty are great role models. It’s wonderful to see that.”

Michigan Chem-E’s—From Now Until Eternity

by Stacy L. Daniels†

From way back then to now, we’ve traveled
The swirling mists of time. A century has passed
Since a new profession was brought forth,
Named Chemical Engineering, or “Chem-E.”

In 1898, ’twas scarcely but a dream of A.H. White,
Who, steeped in chemical technology,
With Edward Campbell, took his hands
To form it from the field of chemistry.

It took some bits of fuel and gas, and metal, too,
To react and forge both engineering and metallurgy
To create two distinct departments,
That mightily increased their entropy.

Professors taught the myriad of students to learn,
By degrees, the Bachelor, Masters, and the PhD.
Raw materials reacting to form final products,
We are the Met, the ChemMet, and the Chem-E.

The faculty, now total ninety strong. Combined
They “professed” a hundred years to such as we.
The list is most famous, learned, but not long;
It ranges (almost) from A to Z.

There are no A’s. Begin with BADGER, BAKER,
BALZHISER, BANCHERO, & BARRY,
BIGELOW, BIKE, BRIER, BRIGGS, and BROWN.
BROWNELL & BURNS complete the B;

CAMPBELL, CARNAHAN, CARRICK, CHURCHILL,
COATS & CURL; DONAHUE; but no E;
FLINN, FOGLER, FOUST, & FREEMAN;
GLOTZER, GODDARD, GORDON, & GULARI, the G;

Move on ahead in alphabetical quest:
HANAWALT, HAND, HOLLEY, HOSFORD, HUCKE;
No I’s or J’s; KADLEC, KATZ, KEMPE, KIMBALL;
To be followed by LAIRD, LARSON, & LESLIE,

LINDERMAN, LIONBERGER; MARTIN,
MASON, McCABE, McCREADY,
MOESEL, MONROE, (We’re half way home.)
Now continue with MONTGOMERY & MOONEY,

And MYERS; no N’s or O’s; so many individuals;
PARRAVANO & PEHLKE, in our fine faculty,
PETTYJOHN, PIERCE, POWERS; No Q;
ROTE, RUDD, & RAGONE;

SAVAGE, SCHNEIDEWIND, SCHWANK, SEIBERT,
SELHEIMER, SINNOTT, & SLIEPCEVICH,
SOLOMON, SPINDLER, SCHULTZ; TEK, THATCHER,
THOMASSEN, THOMPSON, TIEN, TOWNSEND, T’s;

UPTHEGROVE, VAN VLACK, & WANG, Then
WHITE (AE), WHITE (AH), WHITE (RR), all three,
WILKES, WILLIAMS, WOOD; no X’s; YANG & YEH,
YORK, YOUNG, ZIFF, ZIMMERSCHIED; all key.

So when you encounter the vortices of life,
Remember our Professors, as they, their “Profess-
ees.” For as big fleas have their lesser ones,
All travel forward to infinity.

—Stacy L. Daniels (BSE 1960; MSE 1963; PhD 1967)
remembers the wise council of many of the above.

†Chem-E’s = Chemical & Metallurg. Engineering

PHOTO INDEX

Note: This index refers only to the photographs and the few line drawings. The index for the text appears separately, on page 624. A four-digit number, such as 2002, denotes a year and is *not* a page number!

- A**
- A True Story*, watercolor collage, 64
Abbrecht, Peter H., 151
Abdel-Jabbar, Nabil, 294, 297
Abu-Isa, Eyad, 366
Acoustic coupler, 289
Administration Building, 361
Africa, Michael, 299
AIChE Regional Conference 2002, 367, 368
AIChE student chapter character, 365
Alstead, Kelly, 447
Amdek color monitor, 289
Amundson, Neal R., 169
Analog computer, 277
Anderson, Timothy J., 258
Anemometer, 311
Angell Hall, 429
Anturkar, Nitin R., 352
Applied Numerical Methods, title page, 288
Arden, Bruce W., 273
Arens, Scott, 297
Arthur, Michelle, 442
Auto Laboratory, 145, 362
Azurdia, Jose, 447
- B**
- Babcock, Melissa, 294, 297, 395
Badalamente, Tia Marie, 394
Badger Pipe-Fitting Trophy, 384
Badger, Walter L., 16, 109, 309
 1911 letter, 110
 1928 lectures, 111
 cartoon, 390
Bagozzi, Derek, 437
Baker, Edwin M., 20, 21, 116
Balchunas, Brian, 395
Balzhiser, Richard E., 128, 130, 172, 173, 549
Banchemo, Julius T., 124
Band Day 1955, 385
Barry, Robert E., 130
Bartels, Robert C.F., 271, 272
Bates, Michelle, 366
Batesole, Elizabeth, 352
Bautista, Heidi, 289, 416
Beaumont Tower (MSU), 259
Bement, Arden, 476
Bendix G-15 computer, 283
Bennett, Chris, 362
Bennett, Gary, 330
Bigelow, Wilbur C., 128, 130
Bike, Stacy G., 508
Birchmeier, Brett, 232
Bird, Robert B., 84
 DLK lecture handout, 86
Blunk, Richard H.J., 441
Bolen, Cleatis, 179, 458, 459, 460, 461, 468, 601
Bolen, Novella, 601
Bracken, Laura, 469
Brainard, Alan J., 351
Brier, John C., 16, 21, 117, 128
 office, 117
Briggs, Dale E., 130, 251, 313, 358, 363, 460, 489, 526, 540
 sketch, 194
Brinkerhoff, Christopher J., 369
Brophy, Elaine, 478
Brophy, Jere, 478
Brown, David M., 124
Brown, George G., 68, 69, 70, 73, 76, 78
Brown, George Martin, 592
Brownell, Lloyd E., 121, 128
Buesing, Chad, 232
Bunyakiat, Kunchana, 452, 454
Burns, Mark A., 474, 509
Burns, Michael, 437
Burton Tower, 140, 259
- C**
- Campbell, Edward DeMille, 36
Carignan, George, 63
Carleton, W.O., 173
Carnahan, Brice, 130, 153, 163, 185, 219, 271, 294, 298, 357, 363, 439, 441, 478, 483, 489, 528, 546, 620
Carr, Scott, 297
Cast Metals Laboratory, 27, 28
Centennial banner, 473
 memorabilia, 480
Centrifuge, 58
Ceplecha, Steve, 232

- Cepuritis, Gunta, 475
 Cepuritis, Talivaldis, 475
 Chakrabarti, Anjan, 396
 Chang, Peter, 374
 Charoenchaidet, Sumate, 457
 Chaudhry, Prerna, 436
 Chavadej, Sumaeth, 452
 ChE 360 laboratory, 244
 ChE 460 laboratory, 247, 248
 Chemisorption apparatus, 318
 Chemistry Building, 1909, 15
 Chem-Met 16 measurements laboratory, 243
 Chen, John, 155
 Cheng, Yisun, 483
 Chintamaneni, Neil, 297
 Chirachanchai, Suwabun, 451
 Chomistek, Ken, 447
 Chopra, Manish, 362
 Chou, Alice, 366, 447
 Churchill, Renate, 149
 Churchill, Stuart W., 128, 146, 147, 148, 149, 150, 155, 162, 167, 391, 440, 476
 oil painting of, 166
 Claycomb, Lee Brooke, 395
 Clock, presented to Stuart W. Churchill, 164
 Coats, Keith H., 128
 Computing Center, 273
 Concentric-pipe heat exchanger, 312
 Connable, Tenho Sihvonen, 556
 Connell, Douglas, 602
 Constant-volume calorimeter, 354
 Cooley Laboratory, 362
 Cornell, David, 344
 Corrugated-tube equipment, 315
 Cosnowski, Bill, 294, 297
 Cranston, Matthew, 435
 Crystallizer, 58
 "Cube," the, 143
 Cunningham, James J., 371
 Curl, Rane L., 130, 219, 529, 540
 Curl, Vittoria, 219
 Cynthia Miller's bench, 462
- D**
- Daniels, Stacy L., 330
 Dawson, Amy, 395
 Dealy, John M., 163, 357, 391
 Dehmlow, Carla, 480
 Dehmlow, Louis H.T., 480, 553
 Del Valle, Manuel, 554
 Demmler, Albert W., Jr., 479
 Dentistry Building, 361
 Deschere, Bruce, 176
 "Diag," the, 144
 looking north, 430
 Dillon, Kimberly, 393, 395
 "Dinah," 362
 Direct approach, 359
 Director, Lori, 483
 Director, Stephen W., 224, 476, 483
 Distillation column, 248, 413
 "Ditto" machine, 358
 Dodek, Alvin, 394
 Dodge, Barnett F., 160
 Domzal, Rebecca, 366
 Donahue, Francis M., 130, 220, 530
 Donahue, Mary, 220
 Donnelly, Harold G., 348
 Doty, Robert, 433
 Double-effect evaporator, 247
 Double-pipe heat exchanger, 246
 Dow, Herbert H., Building, architect's sketch, 187
 from north, 199
 from northwest, 198
 from southwest, 201
 ground-breaking, 200
 Dow, Herbert Henry, 202
 Drogosz, Frank B., 458
 Duderstadt, James J., 392, 476, 495, 498, 500, 502, 505
 Dunham, Dru, 447
- E**
- East Engineering Building, 18, 55, 141, 405, 561
 front doors, 19
 third-floor office (anonymous), 178
 East Hall, 144
 Eberhart, Harald W., 464, 470
 Electric Furnace Laboratory, 52
Elements of Chemical Engineering, title page, 389
Elements of Materials Science, title page, 170
 Elenbaas, Jack R., 342, 344
 Elevator indicator, 403
 Ellis, John, 143, 451
 Ellwood, Kevin, 441
 Engineering Quadrangle, 363
 Eppler, Ludwig K., 458
 Epson printer, 289
 Evans, Lawrence B., 155, 555
 Evaporator Laboratory, 60, 381
 Evaporators, 53
- F**
- Felczak, Claire, 442
 Ferguson, Stephen, 232
 Fermentation bath, 327
 Finned-tube equipment, 313
 Finned-tube heat-transfer, 311
 Fisher, D. Grant, 277
 Fleming, Robben, 88
 Flinn, Richard A., 128
 Fogler, H. Scott, 130, 208, 209, 457, 478, 511, 608
 sketch, 193
 Fogler, Jan, 608
 Football team, 428
 Forbis, Glen, 294, 297
 Forced circulation evaporator, 51
 Ford, James A., 128
 Foundry, 27, 28, 57
 Foust, Alan S., 24
 Franklin, Valerie, 466

Freeman, James W., 128, 130
 Fume hood, 398
 Funkumai, Kridsida, 451
 "Fuss," 297

G

Galler, Bernard A., 270, 273
 Garman, Christine, 362, 546
 Gawronska, Daria, 436
 Georgiou, Georgios, 352
 Gerstacker, Carl A., 548
 G.G. Brown Building, 362
 Gibala, Ronald, 169
 Gibson, Helen B., 437
 Gibson, William M., 437
 Giszczak, Richard, 477
 Glotzer, Sharon C., 366, 512
 Glucose sensor optode, 332
 Goddard, Joe D., 130
 Goddin, Clifton S., 387, 391, 392, 393, 441, 474
 Goodwin, James G., 321
 Goralski, Chris, 294
 Gordon, Kenneth F., 128
 Gould, Thomas L., 345
 Graduate picnic, 363
 Graduating class,
 May 2001, 444
 December 2001, 445
 May 2002, 446
 Greene, Joseph P., 352, 441
 Griffiths, Robert H., 185
 Gulari, Erdogan, 205, 452, 455, 480, 513, 541

H

Hainey, Elizabeth Batesole, 440, 441
 Halloran, John W., 45
 Hammer, David E., 179, 576
 Hand, James H., 179, 180, 185
 sketch, 197
Handbook of Natural Gas Engineering, title page, 341
 Hard drive, 289
 Heers, Wendell, 490

Helfand, Russ, 416
 Hellums, J. David, 152, 155
 Hennig, Robert, 474
 Hill Auditorium, 145, 419
 Hindelang, Maureen, 395
 Hines, William E., 458
 Hoefner, Mark, 209
 Hoffman, Nathan, 436
 Holleran, Sean P., 369, 374
 Hosford, William F., Jr., 130
 Houser, Matt, 295, 297
 Hucke, Edward E., 128, 130
 Huebner, George, 505, 599
 Huebner, Gertrude V., 440, 599
 Humenick, Michael, 311
 Hummel, Richard A., 128
 Humphrey, Arthur E., 90
 Hunter, John, 135
 Huntingdon, Richard L., 348
 Hutson, Nick, 371

I

IBM 360/67 computing system, 279
 IBM 650 computer, 270
 IBM 704 computer, 273
 IBM PC, 289
 IBM PS/2s, configuration, 291
 Ieumwananonthachai, Ieum, 455, 551
 Ingerson, Madeleine, 177, 186, 601
 Ishida, Hatsuo, 452
 Islam, Bedar, 232
 Islam, Tina, 232

J

Jackey, George, 359
 Johnson, Tim, 436, 442
 Jones, J. Wayne, 439, 482
 Jones, Stanley C., 283
 Jongpaiboonkit, Leenaporn, 232
 Jorgensen, Justin, 232

K

Kadlec, Robert H., 130, 153, 185, 490, 531, 541, 576
 sketch, 192
 Katz, Donald L., 45, 83, 84, 87, 88, 90, 91, 95, 101, 103, 120, 130, 170, 176, 189, 282, 344, 542
 Katz, Elizabeth, 89
 Katz family home, 96
 Katz, Marvin L., 269
 Kempe, Lloyd L., 128, 130, 327, 329, 330, 532, 542
 sketch, 193
 Keyser, Lisa T., 417
 Kimball, Orville F., 130
 Kimerer, Kent, 394
 Kinzer, Tami, 374
 Kiranandana, Thienchay, 452
 Kirby, Brian, 295, 297
 Kitiyanan, Boonyarach, 451
 Kobayashi, Riki, 87, 343
 Komesvarakul, Napaporn, 457
 Konopka, Kathrina, 436
 Kravaris, Costas, 363
 Kuo, Benita, 444

L

Laboratory benches, 397
 Laity, Thomas H., 479
 Lampert, William B., III, 316
 Lao, Tim, 366
 Larson, Ronald G., 222, 224, 474, 514
 LaValle, Pablo, 244, 469, 546
 Lavin, John G., 313
 Law Quadrangle, 388
 Lederman, Peter B., 128, 405, 478, 479, 484, 552
 Lederman, Sue, 479
 Lenz, Debbie, 295, 297, 441
 Lepler, Robert, 295, 297
 Leslie, Emily, 113
 Leslie, Eugene H., 113
 Levenspiel, Octave, 371

LGP-30 computer, 285
 Lightfoot, Edwin N., 371
 Lim, Yiping, 366
 Linderman, Jennifer J., 225, 363, 515
 Lionberger, Robert A., 516
 Lorenz, Chris, 369
 Lund, Kasper, 185
 Lurie Tower, 425, 432, 486
 Luther, H.A., 287

M

Machine shop, 600
 Madingley Hall, Cambridge, 147
 Malakul Na Ayudhaya, Pomthong, 451
 Manantapong, Manat, 456
 Martin, Joseph J., 130, 133, 135, 136
 Martin, Terry, 358
 Mason, Donald R., 314
 Mason, Marilyn, 440
 May, Alvalea, 177
 McAfee, LaRuth, 395, 444
 McCabe, Justin, 435
 McCabe, Warren L., 118
 McCaskey, Harold, 475
 McCready, Donald W., 25, 128
 McCullough, Patrice, 394
 McKetta, John J., Jr., 349
 McNair, J.R., 366
 Meder, Bethany, 424
 Media Union, 425, 486
 Meinke, Wayne W., 121
 Mekasut, Lursuang, 452
 Michigan car, 433, 434
 Michigan Union, 406
 MIDAC computer, 268
 Miley, George, 354, 475, 479
 Miller, Cynthia, 462, 466
 Miller, James, 232
 Mirecki-Millunchick, Joanna, 482
 Mohraz, Ali, 369
 Mongkolkul, Kamchad, 451, 453
 Monroe calculator, 269

Monterio, Anne, 615
 Montgomery, Susan M., 517, 546
 Mooney, David J., 518
 Moore, Arthur D., 615
 Moore, E.V., Building, 143
 Mössbauer spectrometer, 321
 Motyl, Jessica, 366, 447
 M-Pulse solar car, 547
 Muehlig, Erwin, 602
 Murray, Hannah, 366, 447

N

Nagle, David, 295
 Nagler, Billie, 480
 Nagler, Charles, 480
 Neuman, Alfred E., 488
 Nguyen, Duc Anh, 440
 Nicklin, Donald J., 439, 441
 Nithitanakul, Manit, 451
 Norman, Robert L., 128, 248
 North Campus, 1958, 362
 fountains, 432
 from southeast, 214
 from southwest, 210
 from the Arboretum, 431
 from the hospital, 409
 March 1961, 145
 North University Building, 273
 North University Street, 145

O

Organick, Elliott I., 284, 285
 Osburn, Scot, 295, 297
 Osuwan, Somchai, 452, 453
 Otto, Fred, 317

P

Papanastasiou, Tasos, 352
 Parker, Barbara, 479
 Parker, F. Drake, 380, 384, 479
 Parker, Peter, 185
 Parking permit, 564
 Parravano, Ernestina, 132
 Parravano, Giuseppe, 128,

131
 sketch, 195
 Pasternak, Andrew, 394
 Pattamaprom, Cattaleeya, 479
 Pehlke, Robert D., 130, 183, 474
 Petroleum and Petrochemical College, 448
 Pettibone, Max E., 555
 Phoenix Memorial Laboratory, 145, 362
 Pierce, Walter B., 128
 Pilko, George, 550
 Pinamont, Betty, 613
 Pinamont, Carl, 613
 Ployer, Murray, 358
 Podbielniak centrifugal solvent extractor, 62
 nameplate, 62
 Podbielniak Reading Lounge, 63, 298
 Podbielniak, Nancy, 63
 Podbielniak, Walter J., 61
 Podsiadlo, Arkadiusz, 436
 Poettmann, Fred H., 344
 Polymerization reactor, 317
 Powers, John E., 130, 468, 533
 PPC fluid mechanics class, 450
 PPC 1999 graduating class, 449
 Prausnitz, John, 221
 President's house, 142
 Printing Services Building, 362
 Punched card, 276
 Punting on the Cam, 148
 Pyett, Stacy, 374

Q

Quarderer, George, 487, 575

R

Rackham, Horace H., School of Graduate studies, 141
 Ragone, David V., 103, 128, 201

Rangsunvigitt, Pramoch, 451
 Rasulis, Mich, 295
 Ratliff-Hammer, Demi, 362
 Reagan, President Ronald, 101
 Reddy, Vinay, 295
 Rengan, Aishwarya, 444
 Rennell, James, 295, 297, 441
 Research equipment, 357
 Rhee, Byung W., 316
 Riddle, Kathryn W., 369, 374
 Ries, Kelly, 444
 Ringo, Decker, 366
 Robinson, Ken, 480
 Roeder, Eric, 396
 Rolfs-Curl, Alice, 219
 Ruppert, Joyce, 466
 Rushton, J. Henry, 20
 Ryan, James, 609

S

Salloum, Melissa, 366, 447
 Samuels, Michael, 153
 Sapakie, Sidney F., 411
 Savage, Phillip E., 519
 Saville, Dudley A., 153, 155
 Scamehorn, John F., 452
 Schechter, Robert S., 103
 Scheideman, Cheryl, 435
 Scherer, Julie, 296
 Schneidewind, Richard, 21, 29, 128
 Schultz, Jane, 483
 Schultz, Jerome S., 130, 204, 206, 332, 392, 474, 483
 sketch, 196
 Schwank, Johannes W., 212, 219, 520, 543
 Schweiss, Dieter, 362
 Schwing, Richard, 354
 Seefeldt, Kurt, 371
 Seider, Diane, 158
 Seider, Warren D., 155, 158, 474, 480, 620
 Severn, Nettie, 601
 Severn, Peter, 463, 464, 601
 Shapiro, Harold T., Library,

421

Shippey, Fred, 480
 Siebert, Clarence A., 130
 Silver, Howard, 350
 Singh, Probjot, 362
 Sinnott, Mary, 358
 Sinnott, Maurice J., 128, 534, 543
 Sirota, Eric, 366
 Skinner, James, 355
 Sleicher, Charles A., 155, 474, 478
 Slipecevic, Cedomir M., 72, 122, 123, 189, 567
 Smith, Dean L., 355
 Smith, Molly, 374
 Smith, Phillip, 314
 Soderstrom, Sara, 485
 Softball teams, 376
 Sohma, Hanji, 401
 citation, 399
 letter, 402
 signature, 403
 Solomon, Michael J., 362, 521
 Solomon, Tesfu, 369
 Sommerfeld, Jude, 318
 South State Street, 423
 South University, 11
 Specht, Ben, 395
 Spindler, William A., 128
 Spink, Don, 478
 Spink, Helen, 478
 Squires, Robert G., 319
 Srinivasan, Keeran, 465
 Staples, Mark, 445
 Stills, 60
 Stone, Bennett, 296
 Street, James R., 161
 Sutor, Angelo, 447
 Sullivan, Eugene C., 39, 95
 Suwunnamek, Ittiporn, 457
 Swenson-Walker crystallizer, 50
 Swift, Elisabeth, 63
 Swisher, Sandra, 466, 471, 546

T

Takulpakdeechoumpon, Settawat, 457
 Talbott, William H., 185
 Tantayakom, Veerapat, 457
 Tek, Gretchen, 479
 Tek, M. Rasin, 128, 130, 219, 340, 474, 479, 535, 544
 Teletypewriter, 280
 TenBroeck, Howard, 443
 TenBroeck, Jane, 443
 Thai fruits, 457
 Thai students, 450
 Thatcher, Robert, 467
 Thatcher, Sharon, 466, 467, 468, 478, 599
 Thibonnier, Alex, 366
 Thomassen, Lars, 128
 Thompson, Levi T., Jr., 522
 Tien, Li-Chiu, 154
 Townsend, Richard E., 128
 Towsley, Harry A., 201
 Traffic lights, 360
 Tray-efficiency equipment, 353
 Trojan, Paul K., 128
 Tsao, George T., 327, 328

U

Ulaby, Fawwaz T., 224
 Ulicny, John C., 179, 440, 441
 Ulrich's Bookstore, 410
Unit Operations, title page, 77
 Unit Process Laboratory, 50
 Upthegrove, Clair, 21, 26

V

Valanju, Mayur, 427
 Van Vlack, Lawrence H., 128, 130, 168, 169, 170
 Van Wormer, Laura, 394
 Van Wylen, Gordon J., 165
 Vapor/liquid equilibrium equipment, 350, 351
 Vary, John A., 344

W

Waldecker, Jim, 372
 Waller, Anna, 479
 Wang, Henry Y-N., 335, 523
 Warzel, Larry, 353
 Washtenaw Bar, 492
 Wattana, Piyarat, 362, 456
 Wei, James, 476
 Weissenberg, Karl, 359
 West Engineering Building,
 142
 Westman, Tim, 296
 Wheaton, Kristina, 396
 White, Alfred H., 20, 21, 38,
 39, 41, 43, 44, 73, 95
 70th birthday menu, 42
 desk, 547
 inscription, 407
 White, Mary J., 43
 White, Rebecca, 43, 44
 White, Robert R., 125, 159,
 348
 Wilcox, Willard I., 29
 Wilkes, James O., 63, 130,
 147, 155, 174, 185, 186,
 232, 284, 296, 297, 298,
 352, 362, 363, 384, 392,
 439, 441, 474, 478, 479,
 536, 544, 599
 Wilkes, Mary Ann Gibson,
 63, 148, 360, 362, 439,
 478, 599
 Williams, G. Brymer, 63,
 128, 130, 246, 358, 413,
 440, 484, 537, 563, 599,
 604
 Williams, Rosemarie Wes-
 son, 352, 441
 Williams, Ruth, 563
 Williams, Thomas, 296
 Willow Run Laboratory, 268
 Wilson, Gina, 372
 Wojciechowski, David, 433
 Wolf, Barry, 362
 Wolf, Van J., 475
 Wood, William P., 119
 Woods, Randy, 232
 Woolf, Peter, 369
 Wright, Ray, 232
 Wu, Annie, 296
 Wurster, John, 461, 601, 602
 Wurster, Kathryn, 601

Y

Yang, Frances, 362
 Yang, Ralph T., 63, 218, 219,
 221, 362, 474, 475, 524
 Yee, Albert F., 475
 Yeh, Angela, 395, 422
 Yeh, Gregory S-Y., 130, 538
 York, J. Louis, 128, 130, 550
 Young, Edwin H., 128, 316,
 539, 545
 Young, Tamika L., 445

Z

Zajic, Stefan, 149
 Ziff, Robert M., 363, 525,
 545
 Zone-refining apparatus, 314

TEXT INDEX

Note: This index refers only to items in the text, and does not include the long list of names on pages 260–266 (students entering the teaching profession). The index for the photographs appears separately, on page 637. The prefix “(GBW)” on an item means that it is recalled by Brymer Williams in Chapter 21. A four-digit number, such as 1976, denotes a year and is *not* a page number!

- | A | | B |
|---|--|---|
| A.H. White Fund, 187 | Al-Tamimi, Abdulrahman I.,
316 | “Back to Joe’s and the
Orient,” 403 |
| Abbrecht, Peter H., 151, 156,
312, 333 | Amdahl 470/6 computer,
281 | Bader, Fredric, 174 |
| Abdel-Jabbar, Nabil M.,
254, 305 | Ame and Catherine Ven-
nema, 208 | Badger, Walter L., 16, 108,
307, 390, 392, 397 |
| Abel, Harold, 574 | American Chemical Society,
99 | biography, 109
(GBW), 581 |
| ABET, 503 | American Gas Association,
51, 98, 180 | pipe-fitting trophy, 112,
307, 384, 482, 559, 618 |
| Acidization, of clay, 181
of porous media, 193 | monographs, 348 | relationship with students,
109 |
| Ackenburg, Robert, 161 | Aminian, Khashayar, 352 | Baker, Edwin M., 17, 108,
308, 384, 397, 560, 567 |
| Addington, D.V., 189 | AMOCO Corporation, 254 | biography, 115
(GBW), 579 |
| Adsorption, 225 | Amundson, Neal, 622 | Baldwin, Wareham S., 14 |
| Africa, Michael A., 299, 468 | Analog computing, 276 | Balekjian, Garen, 312 |
| Ahlbeck, Richard, 622 | Anderson, Timothy J., 258 | Ballroom Dancing Club, 418 |
| Ahluwalia, Jolly S., 303, 348,
352 | Angell Hall, 429 | Balzhiser, Richard E., 98,
156, 161, 163, 239, 412 |
| AICHE, alumni mentorship
program, 367 | Anniversary, 50th, 22, 31
(GBW), 593 | biography, 549 |
| distillation project, 268 | program of events, 32 | chairmanship, 172
(GBW), 597 |
| presidents, 576 | Anturkar, Nitin R., 304 | BAM strike (GBW), 605 |
| AICHE student chapter, 95,
179, 183, 364 | <i>Applied Numerical Methods</i> ,
238, 288, 488, 620 | Banchero, Julius T., 31, 567 |
| 1976 regional conference,
188 | Appold, Norman, 404 | biography, 124 |
| 2002 regional conference,
367 | Arboretum, Nichols, 430 | courses taught, 125
(GBW), 589 |
| formation in 1922, 30, 47 | Arden, Bruce W., 271, 274 | Barker, E.E., 160 |
| happy hours, 366 | Argue, Theodore C., 190 | Barnes & Noble Bookstore,
421 |
| weekly luncheons, 365 | Aris, Rutherford, 88 | Barry, Robert E., 314 |
| Akiya, Naoko, 305, 370 | Aroyan, Harry J., 350 | Bartels, Robert C.F., 159,
272 |
| Alaie, Seyed M., 304 | Artificial kidney, 325 | |
| Alka-Seltzer, 434 | ASPEN, 254, 423, 425 | |
| Allenel Hotel, 565 | Atkins III, Daniel E., 89 | |
| Alpha Phi Omega, 428 | Attwood, Stephen S., 164,
184 | |

- Bartholomew, Richard N., 310
 Bartus, David B., 303
 BASIC language, 621
 Basket-type evaporator, 308
 Bath, Thomas D., 155
 Beatty, Kenneth O., Jr., 310
 Beer drinking, 406
 Beffel, Michael J., 303, 316
 Bell, John, 241
 Bell, Pretzel, 406
 Bement, Arden, 476
 Benham, Alvin L., 350
 Bennett, Gary F., 328, 331
 Benton Dwight F., 221
 Bergelin, Olaf, 403
 Bergman, Dave F., 188, 348, 352
 Berry Brothers Paint Company, 436
 Berry, Thomas, Memorial Fellowship, 52
 Bhalla, B.D., 348
 Bhatia, Martha TenBroeck, 443
 Bhatia, Paul, 443
 Bicher, Leo B., Jr., 349
 Bike, Stacy G., 210, 220, 221, 240, 422
 bioengineering research, 338
 biography, 508
 Bilich, Karen, 183
 Bimbo's, 617
 Biochemical engineering, 182
 option, 335
 Bioengineering, 30
 Biomaterials, 195
 Biomedical research, 324
 Biotechnology and bioengineering, 326
 Biotechnology and biomedical engineering, 1996, 213
 Biotechnology, 225
 Bjork, Harold, 112
 Black Action Movement, 605
 Blum, Ofer, 220
 Blunk, Richard H.J., 305
 Boarts, Robert M., Jr., 310
 Boberg, Thomas C., 346
 Bocquet, Phil, 324
 Bolen, Cleatis, 602
 biography, 459
 ("Fanny"), 408
 Bonventre, Peter F., 328
 Border's Bookstore, 421
 Borgmann, Carl, 603
 Bower, Melissa, 468
 Bracken, Laura D., 468
 biography, 469
 Brainard, Alan J., 351
 Bridge matches, student/faculty, 185, 188
 Brier, John C., 16, 31, 151, 161, 162, 178, 189, 383, 397, 489, 559, 566, 616
 biography, 117
 "Cactus Jack," 118
 (GBW), 580
 Briggs, Dale E., 139, 163, 179, 182, 189, 194, 220, 251, 253, 315, 422, 619
 biography, 526
 Brinkerhoff, Christopher J., 370
 Britton, Earl, 622
 Brockway, L.O., 160
 Brooks, Charles H., 310, 560
 Brophy, Jere Hall, 559
 Brosilow, Benjamin, 304
 Brown Industries Inc., 249
 Brown Jug, 410
 Brown, George G., 17, 31, 108, 160, 339, 341, 347, 389, 397, 487, 559, 566, 568, 608, 611, 612, 616, 617
 AIChE president, 69
 approach to first and second laws of thermodynamics, 79
 awards, 69
 becomes dean, 91
 biography, 67
 chairman of department, 68
 changes in curriculum, 75
 classroom approach, 73
 dean of College of Engineering, 70, 164, 572
 development of North Campus, 78
 doctoral thesis, 67
 Edward DeMille Campbell University Professor, 21, 69
 (GBW), 577
 last course, 77
 recollections by C.M. Slipevich, 71
 research interests, 67, 68, 74
 teaching thermodynamics, 71, 76, 79, 160
 Unit Operations, 68, 78
 Brown, G.G., Building, 246
 Brownell, Lloyd E., 30, 31, 189, 252, 342, 567
 biography, 120
 (GBW), 589
 "Brown's Brats," 567, 589
 Bull, Daniel, 329, 331
 Bunsen, Robert, 114
 Buntin, Bill, 618
 Bunyakiat, Kunchana, 454
 Burns, Mark A., 210, 221, 225
 bioengineering research, 337
 biography, 509
 Bursley Dormitory, 420
- ### C
- CACHE Committee, 184, 190
 CACHE Corporation, 240
 CAEN (Computer-Aided Engineering Network), 289, 267, 605
 CAEN laboratories, 199
 Calvert, Seymour, 577
 Campbell, Edward DeMille, 13, 35, 39, 255
 appointed assistant professor, 35
 director of Chemical Laboratory, 37
 laboratory accident, 35

- lectureship, 28
 publications of, 37
 Campbell, Harry L., 29
 Campbell, Roger, 177
 Candidacy, 231
 Canfield, Herb, 609
 Canham, Don, 573
 Canoeing, 577
 Card programmed calculator, 268
 Career Fair, 379, 485
 Carignan, George, 65
 Carleton, Finis E., III, 156, 315, 483, 494, 617
 Carnahan, Brice, 139, 163, 184, 188, 190, 206, 221, 239, 267, 271, 285, 286, 288, 291, 342, 430, 439, 449, 482, 494, 619, 620
 biography, 527
 evening computing lectures, 285
 Ford computer project, 284
 (GBW), 606
 reminiscences, 619
 Carr, John W., III, 268
 Carrick, Leo L., 25, 31
 Case, Lee O., 160, 407, 560
 Cast metals, research, 29
 Catalysis research and teaching, 317
 Catalytic surfaces, 181
 Celery-seed oil, 398
 Centennial, department, 222, 384, 473
 banquet, 481
 carillon concert, 477
 lunch & events, 477
 symposium, 475
 Centennial, College of Engineering, 404, 573
 Chan, Elaine, 370
 Chan, Lilan L-Y., 302
 ChE 360, 244
 ChE 460, 246
 ChE faculty/student softball, 377
 Cheever, Byron W., 12, 35
 Chem/Met picnic, 185
 Chem-E-Car Competition, 367, 433
 Chemical Engineering Graduates Society (ChEGS), 368
 Chemical Laboratory, 13
 Chemical technology, 228
 Chemistry Building, 1909, 15
 Chemistry, 56
 Chen, George T.S., 315
 Chen, John C., 154, 167, 313
 Chin, J.H., 154
 Chipman, John, 28
 Chludzinski, George R., 156, 314
 Chopra, Manish, 305, 370
 Chrysler Center, 202
 Chu, C.M., 153
 Chulalongkorn University, 448
 program, 233
 Churchill, Stuart W., vi, 260, 311, 342, 439, 475, 490, 603, 620
 80th birthday, 167
 AIChE president, 148, 164
 awards, 148
 biography, 146
 chairmanship, 147, 162
 (GBW), 605
 research interests, 150
 teaching interests, 157
 Clark, Claude L., 27
 Clark, George C., 154
 Clifford, Clark, 598
 Coal slurries, 183
 Coal research, 179
 Coates, Jesse, 309
 Coats, Hal B., 612
 Coats, Keith H., 345, 346, 348, 350
 reminiscences, 612
 Collamore, William C., 150
 Collins, Cynthia G., 468
 Colloid and surface science, 1996, 215
Column, The, 364
 Colver, Charles P., 314
 Combined B.S.E./M.S.E. program, 233
 Complex fluids, 220, 225
 Composites, carbon/elastomer, 180
 Computer games, 183
 Computer-based research, 300
 Computer-oriented doctoral dissertations, 301
 Computers and computing, 267
 Computers in engineering design education, 286
 Computing Center, 267, 272, 278
 Connable, Tenho Sihvonen, biography, 556
 Connell, Doug, 459, 603
 Constock Liquid Methane Corporation, 123
 Contract research, 237
 Cook Law Quadrangle, 388
 Cooley, Mortimer E., 41, 55
 Copeland, Bob, 179
 Cornell, David, 343, 347, 350
 Correll, Elizabeth H., 87
 Corty, Claude, 311
 Cosway, Harry, 350
 Coulter, Ken, 254
 Courses offered, 1911–1912, 228
 Course options, 2002, 229
 Course requirements, 1912–2002, 227
 (ChE), 2002, 229
 Courses taught, 1995–2002, 235
 Crane, Richard, 582
 Crisler, Fritz, 598
 CRISP, 418
 Crozier, Ronald D.G., 268
 Crull, Maxine, 87
 Cultural diversity, 429
 Cunningham, James J., 370
 Cunningham, Mark, 601
 Curl, Rane L., 139, 181, 220, 238, 246, 249, 412, 616, 618
 biography, 529
Curriculum 2000, 297
 Curriculum, graduate, 49
 undergraduate, 49, 55
 Cypert, Leslie B., 468

D

- Dalston, Jephtha, 573
 Daniels, Stacy L., bioengineering research, 329
 poem, 623
 Darden, Oliver, 618
 Darling, Elmer, 459, 603
 David, Ed, 98, 598
 Davis, W.H., 386
 Degrees awarded, 1973, 174
 1998–1999, 250
 by decade, 249
 through 1952, 22
 Degree program established, 1898, 33
 Degree requirements, 1898, 33
 1905, 14
 1923, 59
 1912–2002, 227
 Dehmlow, Louis H.T., biography, 553
 Del Valle, Manuel, biography, 553
 Delgass, W. Nicholas, 320
 Dennison, D.M., 160
 Department computing, 1995–2002, 299
 Departmental organization (GBW), 596
 Departments, separation of, 203
 Depression, the, 23, 48, 619
 Design courses, equipment, 21
 process, 21
 “Diag,” the, 430
 Dickinson, John, 581
 Director, Stephen W., 475
 Distillation column, 413
 Doctoral Committee, role of, 232
 Dodge, Barnett F., 161
 Donahue, Francis M., 139, 181, 188, 190, 220, 616
 biography, 530
 Donald L. Katz Lectureship, 209, 443
 Donnelly, Harold G., 350
 Dorothy Hall, 559
 Doty, Robert, 434
 Double-pipe heat exchanger, 413
 Douglas, Silas H., 12
 Dow Chemical Company, 109, 179, 183, 187, 202, 254, 329, 566
 Dow Connector Building, 199
 Dow Foundation, 187, 199
 gift from, 174
 Dow mezzanine, 423
 Dow, Herbert H., 202
 Dow, Willard H., 48
 Downey, Rebecca M., 45
 Drasin, Hugo, 387, 391
 Dreisbach, Sam, reminiscences, 618
 Drogosz, Frank, 459, 491
 Duderstadt, James J., 200, 239, 289, 476, 574, 605
 Centennial speech, 495
 Dudley, Isabel, 563
 Duncan, Michael, 183, 239
 DuPont Company, gift from, 174
 Dyer, Thelma, 600
 Dynamic objectives for chemical engineering, 97
 DYSCO, 182, 254
- E**
- Earle Hotel, 565
 East Engineering Building, 94
 occupied in 1923, 17
 East Quadrangle, 411, 565
 Eberhart, Harald W., 468
 biography, 470
 Eberhart, Wolfgang R., 470
 Economics Building, 15
 Educational innovations, 237
 Eichhorn, Jacob, 311
 Electrochemical, engineering, 1996, 217
 polymerization, 181
 research, 181
 Electrochemistry, 22
Elements of Chemical Engineering, 109, 118, 581, 593
Elements of Chemical Reaction Engineering, 240, 322
Elements of Materials Science, 598
 Elenbaas, D.J., 344
 Elenbaas, Jack R., 184, 342, 343, 344, 346, 347
 natural gas engineering, 339
 Eliassen, J.D., 173, 239
 Ellwood, Kevin R.J., 304
 Elzinga, Eugene R., Jr., 312
 Embassy Hotel, 565
 Emission control, 182
 Emmanuel, Jorge, 316
Encyclopedia of Chemical Engineering Equipment, 240
 Engineering, Career Center, 423
 Council, 370
 Criteria 2000, 503
 education for the 21st century, 495
 Honors Brunch, 394
 Humanities Department, 570
 Research Department, 397
 Research Institute, 22, 28, 154, 255, 600
 ENIAC, 267, 323, 603
 Enrollments, 1929, 50
 1973, 174
 1975, 182
 1976, 187
 many sophomores, 17
 through 1948, 22
 Enzymes, 181
 Epeians, 422
 Evans, Lawrence B., 154, 155, 156, 167, 184, 254, 313
 biography, 554
 Evaporator laboratory, 53, 560
 Evaporator salt run, 382
 Excel, 425

F

- Faculty, list of,
1930, 108
1948, 31, 138
1959, 129
1968, 131
1972, 175
1980, 139
- Fagley, John C., Jr., 254, 303
- Falender, James R., 139
- Famularo, Jack, 604
- Farmer's Market, 419
- Farrant, Leslie A., 180
- Fatica, Nicholas, 310
- Faulkner, Richard C., 351
- Festifall, 427
- Fichthorn, Kristen, 304
- Fields, Yakeitha, 370
- Filisko, Frank, 197, 334
- Final oral examination, 232
- Fink, D.J., 181
- Fink, William, 20
- Finned-tube research, 310
- Firoozabadi, Abbas, 346
- Fisher, D. Grant, 302, 314
- Fission Products Laboratory, 120
- Flash vaporizer, 182
- Fleming, Robben, 572
- Fleming, Sally, 575
- Fletcher's Drug Store, 562
- Flinn, Richard A., 30, 342
- FLOWTRAN, 254
- Fluid Mechanics for Chemical Engineers*, 240
- Fogler, H. Scott, 89, 139,
181, 184, 190, 193, 224,
237, 239, 434, 449, 452,
465, 493, 570, 616
bioengineering research,
338
biography, 510
catalysis research, 322
chairmanship, 208
(GBW), 607
research interests, 208
- Follett's Bookstore, 410
- Food and drug sterilization,
120
- Forced-circulation evaporator,
307
- Ford, Edsel, 582
- Ford Foundation Computer
Project, 104, 238, 273,
282, 408
(GBW), 603
- FORTRAN, 272, 288
batch job, 281
for the Macintosh and
IBM PS/2, 297
- Foster, George, 461
- Foundry, 17, 54, 561
- Four "B's," the, 117
- Foust, Alan S., 24, 31, 310,
566
(GBW), 580
- Fox, Terence R.C., vi
- Fragen, Nathan, 309
- Franklin, Valerie, 207
- Freeman, James W., 27, 31
- Freshman computing instruction,
291
- Friedman, M.H., 154
- Frye, Don, 163
- Future Car, 427
- G**
- Gahman, Robert L., 315
- Galler, Bernard A., 267, 269,
271, 274, 605
- Galler, Enid H., 557
- Galvagno, Signorino, 320
- Garman, Christine M., vi,
468
- Gas Processors Association,
99
- GAT, 271
- Gealer, Roy L., 154
- German language examination,
234
- Gerstacker, Carl A., biography,
548
- G.G. Brown Industries, 331
- G.I. Bill, 568, 611, 612
- Gibala, Ronald, 169, 464
- Gibson, Elaine, 437
- Gibson, Helen B., 438
scholarships, 435
- Gibson, William M., 435
- Gillies, Robert A., 327
- Giszcak, Richard, 478
- Gland, John, catalysis research,
322
- Glotzer, Sharon C., biography,
512
- Gluckstein, Martin E., 154
- Goddard, Joe D., 157, 180,
189, 190, 334
- Goddin, Clifton S., 301, 364,
569, 619
prize, 392
reminiscences, 387
- Gomberg, Moses, 39, 383
- Goodwin, James G., Jr., 156,
320
- Gordon, Kenneth, 487
- Gorring, Robert L., 351
- Gould, Thomas L., 302, 345,
346, 351
natural gas engineering,
339
- Govier, George W., 310, 346
- Grabois, Ronald N., reminiscences,
614
- Graduate, curriculum, 49
enrollment, 1986, 212
program, 2002, 230
- Graham, Robert M., 271,
274
- Graikoski, Jack T., 328
- Great Depression, 380, 387
- Great God Brown, 383
- Green ChEGS softball team,
377
- Green, Gordon, 341
- Greene, Charles E., 14, 34
- Greene, Joseph P., 304
- Greenwold, Douglas, reminiscences,
614
- Griffiths, Robert, 188
- Gronvall, John, 574
- Guffey, Charles, 617
- Gulari, Erdogan, 139, 206,
225, 449, 452
biography, 513
catalysis research, 321
- Gumprecht, Roland O., 267,
301, 323
- Gupta, J.P., 156
- Gupta, Prem J., 188
- Gupta, Rajeshwar K., 312

H

Habitat for Humanity, 432
 Hachmuth, Karl Henry, 340, 622
 Hainey, Elizabeth Batesole, 304, 316, 352, 439
 Halloran, John W., A.H.
 White Collegiate Professor, 45
 Hamlin, Susan E., 468
 Hammer, David E., 139, 303
 wins AIChE design contest, 178
 Hand, James H., 139, 174, 176, 180, 196
Handbook of Natural Gas Engineering, 106, 342
 Handique, Kalyan, 370
 Hannum, John, 400
 Harriman, Norman F., 14
 Harwood, David B., reminiscences, 618
 Hazelton, Russell F., 310
 Heat transfer in evaporators, 24, 309
 Heat transfer, doctoral dissertations, 308
 pool-boiling, 180
 research, 306, 308
 Hebbard, George M., 309
 Heilbronner, Hans, 616
 Hejmadi, Arun, 139
 Helfand, Russ, reminiscences, 414
 Hellums, J. David, 152, 156, 167, 301, 313
 Henderson, W. Ernest, 325
 Herbert H. Dow Building, 187, 198, 335
 dedication, 199
 High-speed cinematography, 181
 High-temperature properties of metals, 26
 Hill Auditorium, 410, 420
 Hines, Bill, 459
 Holcomb, Dysart, 386
 Holder, Gerald D., 188, 352
 Holleran, Sean P., 370

Holley, Clifford D., 16
 Honor Code, 407
 Honors and Awards Luncheon, 438
 Horvath, Chris, 434
 Hosford, William, 483, 490, 577
 Hospital Public Advisory Committee, 573
 Hucke, Edward, 342
 (GBW), 591
 Huebner, Gertrude V., 439
 Hughes, Elenore, *A True Story*, 64
 Hunn, James V., 309
 Hybrid computer, 277
 Hydrates, crystalline, 180
 Hymans, Saul, 574

I

IBM 360/67 computer, 277, 279
 IBM 602-A calculating punch, 323
 IBM 650 computer, 152, 268, 271, 272
 IBM 704 computer, 152, 272
 IBM 7040 computer, 152
 IBM 709 computer, 272
 IBM 7090 computer, 276
 IBM PS/2 computer, 292, 293
 Ibrahim, Maher A., 348
 Ieumwananonthachai, Ieum, biography, 551
 Independent study, 60
 Industrial chemistry, 12, 58
 Industry-related courses, 93
 Ingerson, Madeleine, 184
Inorganic Chemistry Technology, 116
 Institute of Science and Technology, 126, 136
 Instruction modules, 239
 Intercollegiate Athletics, Board in Control, 573
 Internet, 418, 425, 430
Introduction to Chemical Engineering, 125
 Ismail, Nadia, vi

J

Javinski, Marty, 494
 reminiscences, 617
 Johnson, Otis C., 13, 39
 Jominy, Walter E., 27
 Jones, J. Wayne, 439, 483
 Jones, Jesse, 48
 Jones, Millard L., 351
 Jones, S.C., 348
 Jongpaiboonkit, Leenaporn, vi
 Jordan Hall, 563
 Joseph, Larry M., 182
 Judzis, Arvids, 189

K

Kadlec, Robert H., 139, 156, 157, 163, 182, 192, 220, 461, 483, 488, 490, 494, 575, 577, 613, 617
AIChE Journal editor, 190
 biography, 531
 Katz, Donald L., 23, 31, 139, 150, 157, 164, 179, 184, 188, 206, 238, 286, 341, 343, 346, 347, 348, 390, 408, 487, 566, 572, 603, 610, 611, 612, 617, 620
 A.H. White University
 Professorship, 45, 93
 AIChE president, 96
 article on G.G. Brown, 67
 autobiographical sketch, 90
 awards, 99
 biography, 83
 chairman of department, 91
 Coast Guard work, 102
 computer initiatives, 103
 department changes, 92
 doctoral dissertation, 83
 farm work, 83
 Ford computer project, 282
 (GBW), 584
Handbook of Natural Gas Engineering, 83
 interest in nuclear engin-

eering, 96
 Lectureship, 89
 National Medal of Science, 99
 possibilities at other universities, 105
 professional societies, 94
 public service, 102
 retirement, 88
 return to department, 90
 running the department, 91
 sabbatical leaves, 106
 Katz, Linda, 96
 Katz, Marvin L., 95, 313, 346, 348, 351
 Katz, Maxine, 96
 Keinath, Michael, 370
 Keith, Rachel, 574
 Kellex Corporation, 566
 Kelley, R.J., 154
 Kellogg, M.W., Company, 565
 Kempe, Lloyd L., 30, 93, 139, 181, 188, 192, 253, 326, 330, 412, 607
 biography, 532
 Kennedy's assassination, 409
 Kerner, Jeff, 178
 Keyser, Lisa T., reminiscences, 415
 Kim, K.Y., 180
 Kinetics of solution, 181
 Kinzer, Tami, 370
 Kirkpatrick, Sidney D., 91
 A.H. White 70th birthday tribute, 46
 Klee, Howard, 254
 Knott, James E., 199
 Knudsen, James G., 158, 310, 613
 Kobayashi, Riki, 184, 343, 347, 350, 588
 Konopka, Kathrina J., 364
 Kory, Don, 616
 Kravaris, Costas, 212, 221, 494
 Kruggel, Roy W., 151
 Kurata, Fred, 74, 349, 386

L

Laboratory,
 evaporator, 53
 junior, 244
 metallurgical, 54
 microbiological, 177, 182
 measurements, 182
 polymer teaching, 182
 thermal properties of fluids, 180
 undergraduate, 52, 176, 243
 unit operations, 18
 Lacy, Connie, 184
 Laine, Richard, 449
 Laird, Joseph S., 16
 Lampert, William B., III, 316
 Langley, John W., 12
 Lao, Yan-Jeong, 315
 Laporte, Otto, 160
 Larkin, Bert K., 154, 312
 Larson, Ronald G., 220, 449
 bioengineering research, 338
 biography, 514
 chairmanship, 222
 LaValle, Pablo P., 243, 468
 biography, 469
 Lavin, John G., 314
 Lavoisier, Antoine, 114
 Leacock, J.A., 156
 LeaderShape, 422
 Leadership Recognition Dinner, 422
 Learning and teaching, 1996, 218
 Lederman, Peter B., 577
 biography, 267, 552
 reminiscences, 405, 622
 Lederman, Susan, reminiscences, 622
 Lee, Robert L., 89, 344, 347, 348, 352
 Legatski, Harold, 341
 Legatski, Max W., 351
 Legatski, Ted, 341
 Leslie, Eugene H., 17, 108, 386, 612

biography, 113
 (GBW), 577

Leslie Laboratories, 115
 Leslie Science Center, 113, 115
 Levenspiel, Octave, 370
 Li, Lei, 305
 Lievens, J.C., 188
 Lifelong learning skills, 208
 Light scattering, 323
 Lightfoot, Edwin, 370
 Light-scattering functions, 30
 Linderman, Jennifer J., 210, 215, 240, 422
 bioengineering research, 337
 biography, 515
 Lionberger, Robert A., 220, 225
 biography, 516
 Liquefied coal, 194
 Little, Arthur D., 18, 46
 Logan, Leonard A., 309
 Logan, R.W., 348
 Long-tube vertical evaporator, 307, 413
 Lopez, Luis A., 182, 254, 302
 Lorenz, Christian D., 305, 370
 Lucas, Marge, 599
 Luckow, W.K., 156
 Lund, Kasper, 181
 Lunn, Charles A., gift from, 174, 178
 Lurie Engineering Center, 426, 431
 Luther, H.A., 238, 288
 Lyon, Richard N., 310
 Lyon, Robert, 312

M

MacDonald, Robert C., 344
 Macintosh computers, 300
 MAD (Michigan Algorithm Decoder), 274, 288, 412, 487
 sample program, 275
 Malamataris, Nikolaos, 304

- Manhattan Project, 403, 566
 Marchant calculator, 609
 Marcon, Linda, 179
 Marks, Jeanie, 616
 Marks, John D., reminiscences, 616
 Martaniardjo, Shirley, 434
 Martin, David, 449
 Martin, Joseph J., 26, 31, 82, 139, 157, 164, 184, 342, 493, 612
 AICHE president, 135, 178
 ASEE president, 135
 biography, 133
 equations of state, 134
 Founders Award, 178 (GBW), 590
 honorary degree, 135
 teaching thermodynamics, 134
 Martini, Willam R., 151, 301, 312
 Mason, Marilyn, 439
 Materials and polymer processing, 1996, 214
 Materials teaching, 255
 Materials-related courses, 257
 Materials-related research, 225
 Mathematical modeling, 225
 Mathes, John C., 254, 570
 MATLAB, 425
 Maurer, Dave, 370
 McCabe, Warren L., 25, 108, 389, 397, 559
 article on A.H. White, 38
 biographical sketch, 118 (GBW), 581
 McCormack, John, 493
 McCready, Donald W., 25, 31, 108, 383, 388, 397, 488
 (GBW), 582
 McDougald, William, 483, 490
 McGrady, Edsel D., 303
 McGraw-Hill, series of chemical engineering books, 47
 McKeen, J.A., 188
 McKetta, John J., Jr., 97, 350, 613
 McLaren, Jennie, 38
 McNamara, Robert, 598
 McSweeney, Thomas I., 315
 Meder, Bethany, reminiscences, 424
 Media Union, 426, 431, 486
 Meisenberg, Stanley J., 309
 Membranes, transport across, 181
 Mesler, Russell B., 312
 Metallurgy, 35, 41, 50, 57
 Miaw, Chi-Bao, 316
 Michigan Biotechnology Institute, 336
 Michigan Cavaliers, 385
 Michigan Chem-E's, 623
 Michigan Gas Association, 22, 51
 Fellowship, 180
 Michigan Student Assembly, 370
 Michigan Theater, 388, 562
 Michigan Union, 388, 406, 412, 428, 565
 Microbiology for engineers, 332
 MicroCACHE, 239
 MicroMENTOR, 239
 MicroSoft Windows, 299
 MIDAC, 267, 603
 Midland program, 233
 Miller, Bob, 577
 Miller, Cynthia, biography, 462
 Miller, Irving F., 154
 Miller, M.C., 348
 Mirecki-Millunchick, Joanna, 482
 MIT, 18, 162
 course in ChE, 14
 Mitch's Bar, 422, 426
 MITILAC, 271
 Miyazaki, T., 180
 Mizan, Tahmid I., 305, 370
 Modern languages, 56
 Moesel, Charles M., 31
 Mohraz, Ali, 370
 Molecular engineering, 204
 Molini, Alberto E., 327
 Mongkolkul, Kamchad, 454
 Monrad, Carl C., 309
 Monterio, Anne, 599, 615
 Montgomery, Susan M., 223, 224, 227, 240, 299, 422, 430, 485
 biography, 517
 Moon landing, 409
 Mooney, David J., 221, 225
 bioengineering research, 338
 biography, 518
 Moore, Arthur D., 407, 615
 Mössbauer spectroscopy, 181
 Mott's Children's Hospital, 432
 Moyle, Morton P., 154, 156
 M.S.E. degree requirements, 2002, 230
 MTS (Michigan Terminal System), 278
 Muehlig, Erwin, 459, 603
 Mueller, Alfred C., 306, 310, 384, 387
 Mulder, Gerard W., 310
 reminiscences, 395
 Murphy, Donald W., 27
 Murray, Hannah B., 368
 Muscle Shoals nitrate plants, 43
 Myers, John E., 31, 312

N

 Name change, 1935, 20
 National Academy of Engineering, 98
 National football championship, 486
 National hockey championship, 486
 National Science Foundation, 98
 Natta, Giulio, 317
 Natural gas engineering, 339
 doctoral dissertations, 349
 Natural Gasoline Association of America, 52

Natural gasoline, testing,
 manufacturing, and properties, 339
 Navarro, Sylvio, 285, 604
 Nectarine Ballroom, 422
 Neel, James V., 587
 Neuman, Alfred E., 483, 488
 Newberger, Mark, 617
 Nguyen, Duc Anh, 439
 Nicklin, Donald J., 439
 Nielsen, Russell L., 351
 North Campus Commons, 292
 North Campus, inspired by
 G.G. Brown, 78
 move to, 198
 North University Building, 282
 "Not Another Café," 421
 NSF energy traineeships, 184
 Numerical methods, teaching, 289
 Numerical simulation of
 reservoirs, 345

O

Oberfell, G.G., 347
 O'Connell, Harry E., 310, 585
 O'Connor, Claire, 468
 Ohio State game, 1997, 427
 Omega Chi Epsilon, 366, 422, 426, 485
 Oosterbaan, Bennie, 598
 Open-ended problems, 209, 239, 418, 426, 570
 Organick, Elliott I., 285, 604
 "Orient," the, 403
 Orientation, 420
 Ornella, L.F., 154
 Osuwan, Somchai, 454
 Othmer, Donald F., 308
 Overberger, Charles, 574
 Owens, Charles R., 309

P

PACER, 188
 Padilla, Andrew, 314
 Padin, Joel, 370
 Palsson, Bernhard, 206, 211, 334
 bioengineering research, 336
 Papanastasiou, Tasos, 211
 Paritosh, Fnu, 370
 Parker, Barbara, 482
 reminiscences, 618
 Parker, F. Drake, 482, 559
 reminiscences, 380, 618
 Parker, Marion Sarah, 559
 Parker, Peter E., 302
 Parker, Raizemond D., 559
 Parking, 564
 Parravano, Giuseppe, 181, 184, 190, 195, 212, 319, 491
 biography, 131
 catalysis research, 317
 (GBW), 597
 research interests, 132
 Pattamaprom, Cattaleeya, 305, 370
 reminiscences, 623
 Paulus, George F., reminiscences, 613
 Pearson, J.R.A., 177
 Peavy, Claude Clinton, 384, 387
 Pehlke, Robert D., 183
 Peterson, Richard L., 183, 188
 Petroleum and Petrochemical College, Chulalongkorn University, 448
 Petroleum research, 23
 Pettibone, Max E., biography, 555
 Pettyjohn, Elmore S., 108, 566
 Ph.D. degree requirements, 2002, 231
 Phi Alpha Kappa, 403
 Philipp, Lawrence A., 308
 Phillips Petroleum Company, 341, 584
 Physical metallurgy, 20
 Pierce, Robert D., 312
 Pilko, George, biography, 550
 Pinamont, Carl J., reminiscences, 612
 Plasma-arc remelting, 183
 Plastics, 22
 Podbielniak, Nancy, 64, 191
 Podbielniak, Walter J., 61, 341
 centrifugal contactor, 63, 191
 fractionating column, 62, 191
 gift from, 174, 191
 mixed refrigerants, 63
 Reading Lounge, 64
 Poettmann, Fred H., 89, 184, 341, 343, 346, 347, 350
 POLYMATH, 425
 Polymer laboratory, 196
 Pooh-Bah of the Piled Papers Award, 118, 620
 Powers, Gary, 184
 Powers, John E., 139, 179, 180, 412
 biography, 533
 Preliminary Examination, 231, 251
 Prescott, Albert B., 12, 39
 Pretzel Bell, 410, 617
 Process chemical engineering, 93
 Process control and simulation, 1996, 216
 Process design, 251
 courses in 1949, 252
 NSF project, 253
 teaching, 569
 Process Dynamics and Control Laboratory, 277
Process Equipment Design, 120, 252
 Process metallurgy, 20
 Procter & Gamble gift, 249
 Prodany, Nicholas, 493
 Promotion, tenure, and faculty meetings (GBW), 594
 Pump in a basket, 382, 391
 Putnam, David, 370
 Pyett, Stacy, 370

Q

Qualifying Examination, 231
 Quarderer, George, 156, 482,
 575, 577, 617
 Centennial speech, 487

R

Ragone, David V., 342
 budget formula, 205
 (GBW), 591
 Railroad "ticket," 409
 Ralph's Market, 411
 Rate operations, 66
 Ravicz, Arthur E., 252, 301
 Reaction engineering and ca-
 talysis, 1996, 215
 Reactions, 225
 Reagan, President, 207
 Reeves, Robert, 493
 Reflection Pool, 431
 Research, 1986, 210
 2001, 225
 biochemical, 188
 biomedical, 189
 coal, 189
 computer simulation, 188
 electrochemical, 188
 hydrocarbon phase behav-
 ior, 188
 oil shale, 189
 Research facilities, H.H. Dow
 Building, 206
 Rhee, Byung Woo, 316
 Rheo-optical birefringence,
 180
 Rhodes, Frank, 572
 Rick's Bar, 422
 Riddle, Kathryn W., 370
 Riecker, Margaret Ann Tow-
 sley, 200
 Rigg, R.G., 156
 Robertson, Matthew, 434
 Robinson, Donald B., 310
 Robinson, Ken, reminis-
 cences, 619
 Rose Bowl, 1965, 411
 1998, 427
 Rotary Club of Ann Arbor,
 575

Rotary vacuum filter, 413
 Rote, Franklin B., 29, 31
 Rouse, Hunter, 605
 Rue, John D., 16
 Rushton, J. Henry, 383, 569
 Russell, Cazzie, 411, 617
 Ryan, James, reminiscences,
 609
 Rykowski, Rick, 183
 Rzasa, Michael J., 350

S

SACUA, 190, 572
 Sajkowski, Daniel J., remin-
 iscences, 616
 Saltman, William M., remin-
 iscences, 610
 Samuels, Michael R., 153,
 173, 239, 314
 Sapakie, Sidney F., reminis-
 cences, 409
 Sartor, Anthony, 315
 Savage, Phillip E., 210, 221
 biography, 518
 catalysis research, 322
 Saville, Dudley A., 153, 157,
 167, 314, 348
 Schneidewind, Richard, 29,
 31
 (GBW), 582
 Schoch, John, 188
 Schultz, Jane, 207
 Schultz, Jerome S., 139, 180,
 189, 191, 195, 211, 412,
 465
 bioengineering research,
 331
 biographical sketch, 203
 chairmanship, 203
 (GBW), 606
 Schwank, Johannes W., 139,
 206, 317, 320, 449, 452,
 455, 464, 616
 biography, 520
 chairmanship, 212
 (GBW), 607
 Schweppe, Joseph L., 310
 Scorekeepers Bar, 422, 426
 Seader, J.D., 267
 Seefeldt, Kurt, 370
 Seibert, Kevin, 370
 Seider, Diane, 167
 Seider, Warren D., 155, 167,
 184, 286, 302
 reminiscences, 620
 Selheimer, Charles W., 108
 Sensing and microelectronic
 materials, 1996, 217
 Separation into two depart-
 ments (GBW), 598
 memo authorizing, 171
 Severn, Peter, 459, 461, 491,
 602
 biography, 463
 Shapiro, Harold T., 200, 572
 Inaugural Committee, 574
 Shea, Lonnie, 370
 Sherman, Larry G., 348
 Shevket, Fayzan, 387
 Shippey, Fred, reminiscen-
 ces, 621
 Siebert, Clarence A., 26, 31,
 71, 190
 Silver, Howard F., 351
 Sinek, Joachim R., 313
 Singh, Surendra P., 188, 303
 Sinnott, Maurice J., 21, 31,
 139, 164, 176, 222, 255,
 342
 biography, 534
 (GBW), 590
 Skit, graduate student, 2000,
 371
 2001, 374
 Sleicher, Charles A., Jr., 154,
 167, 312
 Slide rule, 405, 412, 424
 Slipeceovich, Cedomir M., vi,
 23, 31, 99, 153, 155, 162,
 190, 267, 342, 556, 567,
 603, 612, 616
 assistant to Brown and
 Katz, 75
 biography, 122
 biomedical research, 324
 first lecture course, 77
 (GBW), 589
 light scattering, 323
 recollections of G.G.

- Brown, 71
 recollections, 65
 research interests, 122
 teaching thermodynamics, 122
 Slurry pipelining, 183
 Slykhouse, Tom, 609
 Smart, Clarence F., 17
 Smith, Dean, 156
 Smith, Lowell R., 346
 Smith, Molly, 370
 Smith, Thomas G., 302
 SOAP, 271
 Social aspects and congeniality (GBW), 595
 Society of Women Engineers, 379, 422, 432
 Soderstrom, Sara, 482
 Centennial speech, 484
 Softball reviews, Jim Waldecker, 377
 Sohma Precision Laboratory, 400
 Sohma, Hanji, 400
 Solomon, Michael J., 220, 225
 biography, 521
 Solomon, Tesfu, 370
 Sommerfeld, Jude, 320
 Souders, Mott, Jr., 309, 339
 Sourush, Masoud, 248
 Sowards, Ruby, 468
 Soy bean oil, 25, 383
 Spectroscopy and catalysis, 195
 Squires, Robert, 320
 Srinivasan, Keeran, biography, 465
 Staff (GBW), 599
 Standiford, Ferris, 112
 Standing, Marshall B., 234, 346, 349
 Start of ChE at U-M, 14
 Statistical Research Laboratory, 269, 272
 Steak & Shake, 410
 Stella, Frank, lithograph, 64
 Sterilization, HTST, 192
 Stevenson, Dwight, 570
 Stinson, Donald L., 341, 350
 Stover, D.J., 188
 Street, James R., 161, 163, 351, 614
 Stroebe, George W., 310, 386
 Stubbs, Gene, 609
 Stubbs, Harry E., 313
 Suchdeo, S.R., 181
 Suding, Paul, 370
 Sundstrom, Donald W., 155, 313
 Swenson evaporators, 17, 51, 65, 109, 237, 382, 560
 Swift, Elisabeth, 64
 Swinehart, Fred, 489
 Swisher, Sandra G., vi, 468
 biography, 471
- T**
- Tanzer, Ernest K., reminiscences, 616
 Tappan, President, 12
 Tau Beta Pi, 397, 422, 428, 432
 Teaching, 289
 2001, 223
 Teaching profession, students entering, 260
 Teaching styles, 157
 Tech Day, 366
 Technical communication, 255
Technical Gas and Fuel Analysis, 339
TechniUM, 174, 179, 182, 187, 191
 Tek, Gretchen, 343
 reminiscences, 622
 Tek, M. Rasin, 139, 179, 183, 190, 341, 343, 346, 347, 348, 348, 492, 609
 biography, 535
 (GBW), 597
 natural gas engineering, 339
 reminiscences, 622
 Teller, Andrew S., 155, 302, 314
 TenBroeck, Jane and Howard, scholarship, 443
 Textbooks by Michigan faculty, 223, 241
 Thatcher, Charles M., 31
 Thatcher, Sharon, 599
 biography, 467
The Macintosh, the PC, and UNIX Workstations, 297
 Theoretical metallurgy, 28
 Thermodynamics, research, 26
 teaching, 26
 Thermodynamics of hydrocarbon systems, 346
 Thomas, L. Kent, 341, 345, 346, 351
 Thomassen, Lars, 20, 31, 108
 Thomassen, Nepo, 178
 Thompson, Levi T., Jr., 210, 221, 240, 463
 biography, 522
 catalysis research, 321
 Thwar, Prasanna, 370
 Tien, Li-Chiu, 154, 155, 302, 315
 Timberlake, Bob, 617
 Timm, Edward E., 181, 493
 Title IX, 573
 Townsend, Richard E., 21, 31, 178, 562
 Towsley Foundation, 187, 199
 gift from, 174
 Towsley, Harry A., 200
Transport Phenomena, 158, 596
 Transport phenomena, 1996, 216
Treatment Wetlands, 576
 Tribus, Myron, 154, 156, 157, 158
 Trombley, Donald A., 468
 Tsao, George T., 334
 bioengineering research, 326
 Tsao, Utah, 310
 Tuition, 1936, 558
 "Twelve Apostles," 39
 Twenty-one-day problem, 230, 251

U

- Udegbumam, Emmanuel O., 348, 352
 Uhlenbeck, George E., 71, 160
 Ulicny, John C., 316, 439
 Ullock, Donald S., 309
 Ulrich's Bookstore, 410
 U-M/MSU joint seminar series, 258
 Undergraduate, instruction, 213
 laboratories, 52, 243
 library, 421
 program, 182
 thesis, 50
 Undergraduate curriculum, 49, 55, 227
 2000, 223
 Unit operations, 18, 51, 238, 383, 407, 560, 616
Unit Operations, 30, 161, 487
 (GBW), 592
 Unit Operations Laboratory, 390, 408
Unit Operations of Chemical Engineering, 593
 University Towers Apartments, 411
 Upthegrove, Clair, 16, 31, 108, 397
 (GBW), 582
 USAID collaboration, 448

V

- Valanju, Mayur, reminiscences, 426
 Valle, Antonio, 303, 316
 Van De Polder, Jody, 200
 Van Vlack, Lawrence H., 164, 203, 257, 342, 483
 chairmanship, 168
 (GBW), 597
 Van Vlack, L.H. and F.E.
 professorship, 169
 Van Wylen, Gordon, 164, 165
 Vary, John A., 184, 342, 343,

347

- Veigel, Fred, 574
 Verma, Vijender K., 180, 352
 Vest, Charles M., 89
 Victor Vaughan House, 565
 Vietnam War 173, 493
 (GBW), 605
 Vigil, R. Dennis, 304
 Vinson, Carl G., 154
 Virtual-reality modules, 241
 Voice Treasures, 557

W

- Waldecker, James R., 370, 372
 Waller, Anna, reminiscences, 623
 Walter J. Podbielniak
 Reading Lounge, 478
 Wang, Henry Y-N., 139, 211, 223, 225, 246, 465
 bioengineering research, 334
 biography, 523
 Ward, Dennis J., 313
 Warden, Robert, reminiscences, 612
 Ware, Elmer E., 16
 Washtenaw Bar, 491
 Waterman Gymnasium, 411
 Weber, Walt, 336
 Wei, James, 476
 Weinaug, Charles F., 343, 347, 349
 Weir, Alexander, 155
 Welcome Day, 366
 Werner, Timothy, 370
 West, Ronald E., 327
 Wetlands treatment of sewage, 182, 192
 Wharton, Clifton, 606
 Wheaton, Kristina, 379
 White, A. McLaren, award, 178
 White, Albert E., 16, 22, 26, 31, 108, 237, 255
 (GBW), 582
 White, Alfred H., 13, 38, 55, 108, 339, 347, 381, 391, 397, 611, 617
 50th wedding anniversary, 43, 94
 70th birthday, 42, 46
 captain in Ordnance Department, 42
 career chart, 40
 (GBW), 578
 head of department, 16, 39
 president of AIChE, 44
 professor of chemical engineering, 14
 work on Portland cement, 39
 White, Alfred McLaren, 45
 White, Mary J., 45
 White, Robert R., 23, 31, 66, 156, 157, 159, 342, 387, 612, 613
 biography, 125
 (GBW), 589
 White, Samuel Holmes, 38
 "Who wants to be a millionaire?," 372
 Wiegand, James, 585
 Wilcox, Willard I., 349
 Wilkes, James O., 65, 139, 152, 157, 163, 167, 207, 220, 222, 224, 244, 267, 286, 288, 291, 301, 314, 342, 348, 393, 412, 437, 449, 452, 482, 483, 494, 575, 577, 612, 615, 619, 620
 article on D.L. Katz, 83
 biography, 536
 chairmanship, 173
 (GBW), 606
 retirement, 439
 scholarship recipients, 442
 scholarships, 439
 Wilkes, Mary Ann Gibson, 267, 437, 438
 Williams, David McK., 558
 Williams, G. Brymer, vi, 23, 31, 65, 139, 164, 179, 181, 184, 189, 190, 222, 254, 268, 326, 341, 342, 343, 439, 461, 482, 483, 487, 612, 616, 617, 619,

622
 acting chairman, 106, 571
 at U–M, 558
 at University of Denver,
 558
 biography, 537
 courses taught, 569
 interview, 557
 retirement, 577
 return to Ann Arbor, 568
 SACUA chairman, 572
 Williams, Rosemarie D.
 Wesson, 303
 Williams, Ruth, 563, 575
 Willow Run Laboratories,
 267, 274
 Wilson, Gary, 183
 Wilson, Gina, 370, 372
 Wilson, Ma, boarding house,
 562
 Winer, Ward, 159
 Withrow, H.J., 342
 Wojciechowski, David, 434
 Wolf, Barry, 370
 Wolverine Tube Company,
 308
 Wolverine-Tube Project, 181
 Women students, 1973, 174
 1975, 188
 Women's League, 406
 Wood, William P., 31, 108
 biography, 119
 (GBW), 582
 Woods, W.B., 188
 Woolf, Peter, 370
 Workstations in 1990, 291
 World Wide Web, 418, 425
 Worsham, Mary, 569
 Wurster, John, 459

X

X-ray laboratory, 18

Y

Yang, Ralph T., 226, 449
 biography, 524
 catalysis research, 322
 chairmanship, 218
 (GBW), 607

Yeh, Angela, reminiscences,
 420
 Yeh, Gregory S.Y., 139, 180,
 197
 biography, 538
 Yesavage, Victor, 617
 York, J. Louis, 24, 31, 164,
 253, 342, 483, 487, 567,
 568
 Award, 489, 619
 biography, 550
 (GBW), 589
 Young, Edwin H., 30, 31,
 139, 181, 184, 190, 222,
 252, 308, 342, 461, 618
 biography, 539
 (GBW), 590
 Young, Tamika L., vi

Z

Zajic, Stefan, 149
 Zaldivar, Michael, 305
 Zartman, William N., 155,
 313
 Zellnik, Herbert E., 151, 313
 Ziff, Robert M., 206, 211,
 221
 biography, 525
 Zimmerli, Franz P., 17
 Zimmerschied, Karl W., 15